

AGPULIE

Australia's Ultimate Range of Contractors Tools

TOOLS & EQUIPMENT CATALOGUE



MASTERFINISH



Easy mix

HEAD OFFICE

ph: 02 9637 9011

fax: 02 9682 1269

sales@masterfinish.com.au

accounts@masterfinish.com.au

29 Parramatta Rd

P.O. Box 309

Granville, NSW, 2142

VICTORIA

ph: 03 9401 5399

fax: 03 9401 5422

TASMANIA

ph: 03 6165 1131

fax: 03 6165 1132

SOUTH AUSTRALIA

ph: 08 7200 3457

fax: 08 7200 3704

WESTERN AUSTRALIA

ph: 08 9350 6255

fax: 08 9451 2312

NORTH QUEENSLAND

ph: 07 4767 7145

fax: 07 4767 7146

QUEENSLAND

ph: 07 3893 2877

fax: 07 3893 2899

WEBSITE

www.agpulie.com.au

FACEBOOK



[www.facebook.com/pages/
AG-Pulie/180338897774](https://www.facebook.com/pages/AG-Pulie/180338897774)

Welcome

Welcome to the A.G. Pulie catalogue. We would like to invite you to browse our catalogue whereby you can find all the world's leading brands in concreting and associated trades, tools and equipment. With decades of experience, you'll find we are the experts in the trade. Please feel free to contact us for any enquiries or for your nearest outlet.

Quality

The management and staff of A.G. Pulie are committed to the best possible professional practice and providing the highest quality services to our clients.

It is our pleasure to introduce a great range of quality products that A.G. Pulie has sourced from Australia and overseas. We have taken the time to listen to our customer's needs and source only the best products for the job.

Technology

A.G. Pulie's research and development team are constantly looking at ways to best serve and supply our customers.

Whether it's an ergonomically designed handle or a light weight material, it's the attention to detail that makes our products stand out from the rest. Ultimately this makes life easier for our customers.

Reliability

What is reliability?

How do we measure it?

1. Consistency
2. Performance
3. Trustworthy
4. Availability
5. Quality

Reliability goals are an essential part in the growth of A.G. Pulie.

Integrity

We behave ethically, are honest and fair with each other and our customers, take responsibility for all our actions and acknowledge that as an organisation we have moral obligations as well as commercial ones.

A Pulie

Albert Pulie
Managing Director

1 Handtools

Concrete

Brick

Render & Plaster

Tile

General

Speciality

1-32

pointed trowels, coves, bullfloats, screeds, rakes...

brick trowels, brushes, trestles...

trowels, hawks...

trowels, spreaders...

tape measures, chalk lines, saws, knives...

texture rakes, bump cutters, asphalt...

2 Sprayers

Industrial

Agricultural

35-44

metal, poly, specialised...

backpack, handheld, specialised...

3 Material Handling

Wheelbarrows

Trolleys

47-62

steel, poly, specialised...

p-handle, sack trucks, fridge trolleys...

4 Machinery

Vibration

Pumping

Saws

Surface Preparation

Power Screeds

Trowel Machines

Cement Mixers

Compaction

65-96

pendulum, high frequency, motor in head...

submersible pumps, hoses, drive units...

bricksaws, roadsaws...

floor grinders, scarifiers...

floating, twin beam, truss...

machines, blades, accessories...

electric, petrol, diesel...

plate compactors, vertical rammers, hydraulic...

5 Formwork

Tools

Accessories

99-102

end cutting nips, wire twisters, bolt cutters...

rebate brackets, kerb bows & plates...

6 Consumables

Concrete Remover

Paint

105-106

acid alternative concrete remover...

line marking paint, gal paints...

7 Merchandising

Merchandising Units

Promotional Items

109-110

2100mm, 1500mm, double sided...

stubby holders, shirts, hats...

8 Index





A.G. PULIE

Section 1 Handtools



MASTERFINISH

MasterFinish handtools... in concrete since 1951



Blue - High Quality Carbon Steel Tool

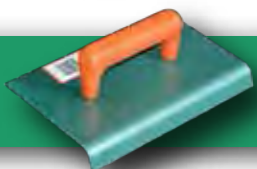

Green - High Quality Stainless Steel Tool

Pointed Trowels



Used for trowelling concrete floors or similar work. The curve of the blade end allows for the reduction of blade end marking. The moulded plastic handle is designed for ease of grip and operator comfort.

Pointed Trowels						
Code	Description	Width	Length	Gauge	Pack Qty	Barcode
109A	Carbon Steel Pointed Trowel	100mm	355mm	Light	6	9318428101096
103A	Carbon Steel Pointed Trowel	120mm	365mm	Heavy	6	9318428101034
165A	Carbon Steel Pointed Trowel	115mm	600mm	Light	6	9318428101652
191A	Carbon Steel Pointed Trowel	115mm	405mm	Light	6	9318428101911
192A	Carbon Steel Pointed Trowel	115mm	450mm	Light	6	9318428101928
193A	Carbon Steel Pointed Trowel	115mm	500mm	Light	6	9318428101935
190A	Carbon Steel Pointed Trowel	100mm	405mm	Light	6	9318428101188
101A	Carbon Steel Pointed Trowel	120mm	365mm	Light	6	9318428101010
161A	Carbon Steel Pointed Trowel	120mm	660mm	Heavy	6	9318428101614
109SS	Stainless Steel Pointed Trowel	100mm	355mm	S/S	6	9318428101904
191SS	Stainless Steel Pointed Trowel	115mm	405mm	S/S	6	9318428291971



109A



109SS

Square Trowels



Used where the pointed end trowel is not suitable e.g. finishing stair toppings and kerb & gutter.

Square Trowels						
Code	Description	Width	Length	Gauge	Pack Qty	Barcode
102A	Carbon Steel Square Trowel	120mm	280mm	Light	6	9318428101027
162A	Carbon Steel Square Trowel	120mm	280mm	Heavy	6	9318428101621
181A	Carbon Steel Square Trowel	115mm	405mm	Light	6	9318428101812



162A

Steel Floats



Used to 'rub up' a concrete floor prior to steel trowelling, to work in coloured dry shake or create a 'cove' or 'stipple' finish. They produce a textured finish smoother than a wood float, which suits outdoor paving applications. The floats feature a long-wearing robust steel blade that is turned up all round.

Steel Floats					
Code	Description	Width	Length	Pack Qty	Barcode
209	Stainless Steel Float	160mm	210mm	6	9318428112092
219	Carbon Steel Float	150mm	380mm	4	9318428112191
229	Carbon Steel Float	100mm	290mm	6	9318428112290

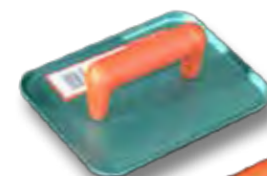

209



219

Wood Floats



The floats feature a long-wearing hardwood face and a lightweight, but tough, orange plastic handle that is adhered to the timber to eliminate marking from screw fixing.

Wood Floats					
Code	Description	Width	Length	Pack Qty	Barcode
801	Wood Float	112mm	300mm	6	9318428178012
802	Wood Float	112mm	380mm	6	9318428178029
803	Wood Float	112mm	450mm	6	9318428178036
804	Wood Float	50mm	450mm	6	9318428178043
824	Wood Float	65mm	600mm	6	9318428129038



824



804

Coving Trowels



Used to form a cove where a wall and floor meet. The 201 coving has a traditional use in 'rubbing up' the setting concrete prior to steel trowelling. If the concrete is left with the finish created by the coving trowel, i.e. a more textured finish than a steel trowelled finish, this is known as a coving finish or 'stipple' finish.

Coving Trowels						
Code	Description	Width	Radius	Height	Pack Qty	Barcode
201	Carbon Steel Coving Trowel	150mm	25mm	70mm	6	9318428112016
202	Carbon Steel Coving Trowel	145mm	25mm	32mm	6	9318428112023
203	Carbon Steel Coving Trowel	95mm	12mm	25mm	6	9318428112030
207	Carbon Steel Coving Trowel	190mm	75mm	90mm	6	9318428112078



207

Concrete Edgers



Used to trowel a smooth finish to slab edges and produce a smooth face margin to textured or wood float finished external paving. The range encompasses a variety of edge radii and blade widths to suit an extensive range of applications. The blades are formed from carbon and stainless steel.

Edging Tools							
Code	Description	Radius	Width	Length	Depth	Pack Qty	Barcode
401	Carbon Steel Concrete Edging	5mm	75mm	140mm	12mm	6	9318428144017
402	Carbon Steel Edging Tool	6mm	75mm	140mm	12mm	6	9318428144024
403	Carbon Steel Edging Tool	10mm	75mm	140mm	19mm	6	9318428144031
404	Carbon Steel Edging Tool	5mm	38mm	140mm	12mm	6	9318428144048
405	Carbon Steel Edging Tool	5mm	50mm	140mm	12mm	6	9318428144055
406	Carbon Steel Edging Tool	6mm	100mm	150mm	14mm	6	9318428144062
406F	Carbon Steel Edging Tool	10mm	75mm	140mm	40mm	6	9318428144161
408	Carbon Steel Edging Tool	19mm	80mm	140mm	19mm	6	9318428144086
410	Carbon Steel Edging Tool	10mm	145mm	230mm	14mm	6	9318428144019
401S	Stainless Steel Edging Tool	5mm	75mm	140mm	12mm	6	9318428144116
402S	Stainless Steel Edging Tool	6mm	75mm	140mm	12mm	6	9318428144123
403S	Stainless Steel Edging Tool	10mm	75mm	140mm	19mm	6	9318428144239
700	Stainless Steel Edging Tool	12mm	150mm	230mm	24mm	6	9318428147001
701	Stainless Steel Edging Tool	25mm	150mm	230mm	24mm	6	9318428147018
702	Stainless Steel Edging Tool	12mm	112mm	175mm	22mm	6	9318428147025
703	Stainless Steel Edging Tool	25mm	112mm	175mm	25mm	6	9318428147032
706	Stainless Steel Edging Tool	10mm	105mm	150mm	14mm	6	9318428147063
708	Stainless Steel Edging Tool	20mm	140mm	200mm	19mm	6	9318428147087
709	Stainless Steel Edging Tool	25mm	220mm	200mm	25mm	6	9318428147094



402

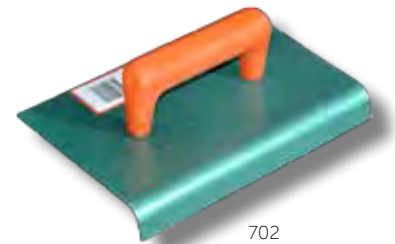

702

Margin Tools



The 775 and 776 margin tools have a fixed margin of 100 and 150. The 777 margin tool has a grooving bit that adjusts to the desired width of margin between 70-160mm.

Margin Tools				
Code	Description	Width	Margin	Barcode
775	Stainless Steel Fixed Margin Tool	140mm	100mm	9318428147759
776	Stainless Steel Fixed Margin Tool	140mm	150mm	9318428147766
777	Stainless Steel Variable Margin Tool	120mm	70 to 160mm	9318428147773



777

Bevel Edger



Used for creating a bevel edge finish on concrete slabs.

Bevel Edgers					
Code	Description	Width	Angle	Bevel	Barcode
413	Carbon Steel Bevel Edger	100mm	45°	25mm	9318428144437
414	Carbon Steel Bevel Edger	125mm	45°	25mm	9318428144345

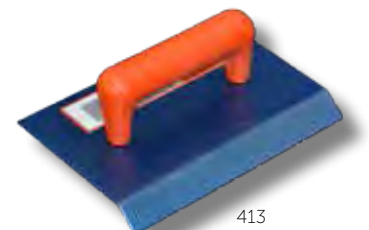

413

Groove Forming Tools



Tools No. 901 and 903 form semi-circular corrugations at 9mm centres. For additional grip on steps.

Tools No. 904 and 905 form an 8mm x 16mm recess that can be filled with non-slip grit.

Groove Forming Tools			
Code	Description	No. of Grooves	Barcode
901	Groover that forms semi-circular corrugations at 9mm centres	3	9318428129014
903	Groover that forms semi-circular corrugations at 9mm centres	5	9318428129038
904	Groover that forms an 8mmx16mm recess	1	9318428129045
905	Groover that forms an 8mmx16mm recess	2 at 19mm apart	9318428129052
905E	905 with step edger	2 at 19mm apart	9318428129076



905E

V Jointers



Used to form 'dummy' joints in concrete paving. The joint in the concrete reduces the thickness of the paving. If cracking occurs, the crack should be at the line of the 'dummy' joint. The joint should be 1/5 of the slab thickness.

The tools are formed from long-wearing steel and have robust, comfortable handles.

V Jointers					
Code	Description	Width	Depth	Pack Qty	Barcode
301	Carbon Steel Vee Jointer	75mm	10mm	6	9318428123012
304	Carbon Steel Vee Jointer	75mm	19mm	6	9318428123043
305	Carbon Steel Vee Jointer	75mm	25mm	6	9318428123050
306	Carbon Steel Vee Jointer	75mm	32mm	6	9318428123067
302	Carbon Steel Vee Jointer	150mm	12mm	6	9318428123029
312	Carbon Steel Vee Jointer	150mm	20mm	6	9318428123128
315	Carbon Steel Vee Jointer	150mm	25mm	6	9318428123159



304



312

Step Nosing



The step nosing tools are made from stainless steel. They are used in forming external corners on cement render.

Step Riser			
Code	Description	Radius	Barcode
501	Stainless Steel Step Nosing	6mm	9318428145014
502	Stainless Steel Step Nosing	10mm	9318428145021



501

Marble Sheen Trowels



Originally developed for use on marble sheen finishing in swimming pools. The blade has flex due to a short support rib (see tool No. 120A, 121A, 122A and 126A).

A further development from this is a similar trowel with a longer rib for greater rigidity in the blade (see the 'S' series).

Marble Sheen Trowels					
Code	Description	Length	Rib Style	Pack Qty	Barcode
120A	Marble Sheen Finishing Tool	300mm	Short	6	9318428151206
121A	Marble Sheen Finishing Tool	350mm	Short	6	9318428151213
122A	Marble Sheen Finishing Tool	450mm	Short	6	9318428151220
122S	Marble Sheen Finishing Tool	450mm with 330mm Rib	Long	6	9318428151329
122SS	Marble Sheen Finishing Tool	122s with Square Back	Long	6	9318428101829
126A	Marble Sheen Finishing Tool	555mm	Short	6	9318428151268
126S	Marble Sheen Finishing Tool	555mm with 380mm Rib	Long	6	9318428151367
126SS	Marble Sheen Finishing Tool	126S with Square Back	Long	6	9318428101843



122A



126S

Plastic Marble Sheen Float



The blade is made from 3mm thick low-density white polyethelene and is fixed to a lightweight plastic handle. Originally developed to trowel marble sheen in swimming pools, but now finds a wider use on various wall applications.

Plastic Marble Sheen Float			
Code	Description	Thickness	Barcode
127	Plastic Marble Sheen Float	3mm	9318428151275



127

Walking Trowels



Trowel concrete floors from a standing position. The tubular connection pivots freely to allow the changing angle between the blade and handle to occur.

The square end blade allows trowelling up against a wall.

Used in conjunction with the telescopic handle 1076 or clip handle 588. See page 27.

Walking Trowels						
Code	Description	Length	Width	End Shape	Pack Qty	Barcode
444	Carbon Steel Walking Trowel	440mm	100mm	Round Ends	6	9318428214444
555	Carbon Steel Walking Trowel	600mm	120mm	Round Ends	6	9318428215557
556	Carbon Steel Walking Trowel	600mm	120mm	One Square End	6	9318428215564
557	Stainless Steel Walking Trowel	600mm	100mm	Round Ends	6	9318428215571
558	Stainless Steel Walking Trowel	600mm	100mm	One Square End	6	931842812884



555



558

Standing Bracket



This bracket may be attached to the handle of tools such as the 302 Groover or the 702 Edger, to allow for fitting to a 1076 or 588 handle. The tools can then be used in positions that are difficult to reach, or simply from a standing position. Tool not included.

Standing Bracket		
Code	Description	Barcode
SB	Standing Bracket	9318428212761



SB

Fresno Trowels



606 - The illustration shows the standard fitting which can be locked at the desired angle. With this fitting the Fresno may also be used as a walking trowel by locking the fitting parallel to the blade. Use with 588 and 1076 poles.

607-609-612 -This Fresno is fitted with a bracket and tilt mechanism as illustrated - used only in a push/pull operation. Use with 588 and 1076 poles, see page 27.

Fresno Trowels			
Code	Description	Length	Barcode
606	Can be locked at desired angle	600mm	9318428216066
607	Fitted with bracket and tilt mechanism	600mm	9318428216073
609	Fitted with bracket and tilt mechanism	900mm	9318428216097
612	Fitted with bracket and tilt mechanism	1200mm	9318428112309

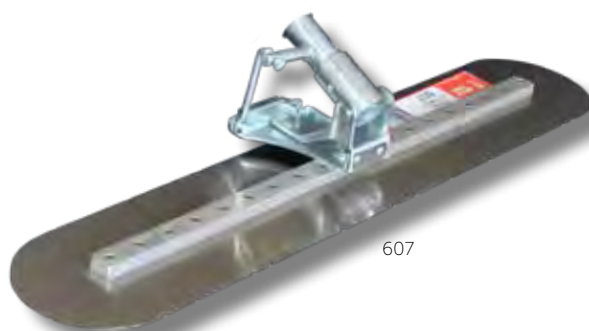

607

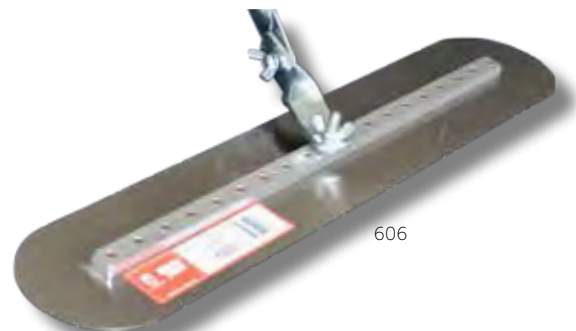

606



Bullfloats

The tilt of the blade is adjustable and controlled by twisting the handle. This enables the operator to change the tilt of the blade (continuously if required) to achieve the optimum finish to the concrete. If the blade lies flat on the slab it leaves a rough finish but will close and fill holes. When the blade is tilted on an angle a smoother finish will result. There is no need to raise or lower the handle, simply twist it for best results. Kraft Bullfloats sold without Knuckle, see page 8.

Bullfloats			
Code	Description	Length	Barcode
1062	Masterfinish Aluminium Bullfloat	600mm	9318428211627
1063	Masterfinish Aluminium Bullfloat	900mm	9318428211634
1064	Masterfinish Aluminium Bullfloat	1200mm	9318428211641
1065	Masterfinish Aluminium Bullfloat	1500mm	9318428211658
1068	Masterfinish Aluminium Bullfloat	1800mm	9318428211085

Kraft Bullfloats			
Code	Description	Length	Barcode
CC736-01	Kraft Magnesium Bullfloat (Knuckle not included)	36" (914mm)	765139326284
CC742-01	Kraft Magnesium Bullfloat (Knuckle not included)	42" (1066mm)	765139326291
CC803-01	Kraft Magnesium Bullfloat (Knuckle not included)	48" (1219mm)	7651396155838



Kraft Bronze Bullfloat Groovers



Use the bullfloat as a groover. Attaches with two thumb screws. Mount as many groover bits as needed. Works on 8" wide bullfloats. Fits the Kraft Bullfloat; CC736, CC742, CC803.

Bronze Bullfloat Groover Bits					
Code	Description	Width	Length	Depth	Barcode
CC940	Bronze Bullfloat Groover Bits	1/2" (12mm)	1/4" (6mm)	3/4" (9mm)	765139619409
CC941	Bronze Bullfloat Groover Bits	1/2" (12mm)	1/4" (6mm)	1" (25mm)	765139619416
CC942	Bronze Bullfloat Groover Bits	1/2" (12mm)	1/4" (6mm)	1-1/2" (38mm)	765139619423
CC943	Bronze Bullfloat Groover Bits	1/2" (12mm)	1/4" (6mm)	2" (50mm)	765139619430



Bullfloat Groover



Produces a uniform sharp groove in various concrete applications where water drainage and traction are critical. Bracket included.

Magnesium Bullfloat Groover			
Code	Description	Length	Barcode
CC794	Kraft Magnesium Bullfloat Groover	36" (914mm)	9318428101867



Bottom View

Kraft Magnesium Channel Float



Great finishing tool - extra strong, making it ideal for many jobs such as flatwork and paving. CC044-01 sold without bracket, CC046SR has bracket included.

Channel Float				
Code	Description	Length	Width	Barcode
CC044-01	Magnesium Channel Float	48" (1219mm)	6" (152mm)	765139615203
CC046SR	Magnesium Channel Float	72" (1823mm)	6" (153mm)	765139325966
CC050	Magnesium Channel Float	10' (3048mm)	6" (153mm)	765139615227



Blue Steel "Big D" Fresno Trowel



Carbon blue steel blade with rounded ends for producing a super smooth finish. Bracket included.

Blue Steel Fresno Trowel			
Code	Description	Length	Barcode
CC750	Blue Steel "Big D" Fresno Trowel	4ft (1.2m)	765139615777
CC751	Blue Steel "Big D" Fresno Trowel	6ft (1.8m)	765139615784



Bronze Fresno Trowel Groover Bits



Change your fresno into a long-handled groover by simply attaching the bronze bits and turning the two thumbscrews. Use more than one bit to make parallel grooves. 1/4" radius. Fits 5" wide fresnos.

Fresno Groover Bits			
Code	Description	Lip Depth	Barcode
CC623	Bronze Fresno Trowel Groover Bits	1/2" (12mm)	765139616231



Kraft Fresno Trowel



Made with a quality tempered steel blade and steel mountings. The EZY-TILT bracket eliminates bending and lifting as it allows for control of the blade pitch through turning the handle. Bracket features a quick and easy coupling for either the 1-3/4" button handle or 1-3/8" button handle. Bracket included.

Kraft Fresno Trowel			
Code	Description	Length	Width
CC830	Fresno Trowel w/Ezy-Tilt Bracket	24" (609mm)	5"-127mm
CC834	Fresno Trowel w/Ezy-Tilt Bracket	48" (1219mm)	5"-127mm



Masterfinish Channel Float



Masterfinish Channel Floats are used in place of traditional bullfloats for flatter floors. The tilt of the blade is adjustable and controlled by twisting the handle. This enables the operator to change the tilt of the blade (continuously if required) to achieve the optimum finish to the concrete. Checked to exact flatness tolerances. Handle not included.

Masterfinish Channel Float				
Code	Description	Length	Width	Barcode
MF712	Masterfinish Channel Float	10' (3048mm)	6" (152mm)	9318428651485



Masterfinish Aluminium Check Screed



The masterfinish Aluminium Check Screed is an early entry restraightening tool. Used to reduce bumps and fill low spots while the concrete is still plastic. The tilt of the blade is adjustable and controlled by twisting the handle. This enables the operator to change the tilt of the blade (continuously if required) to achieve the optimum finish to the concrete. Handle not included.

Masterfinish Channel Float				
Code	Description	Length	Width	Barcode
MF713	Aluminium Bump Cutter	10' (3048mm)	4" (102mm)	9318428651508

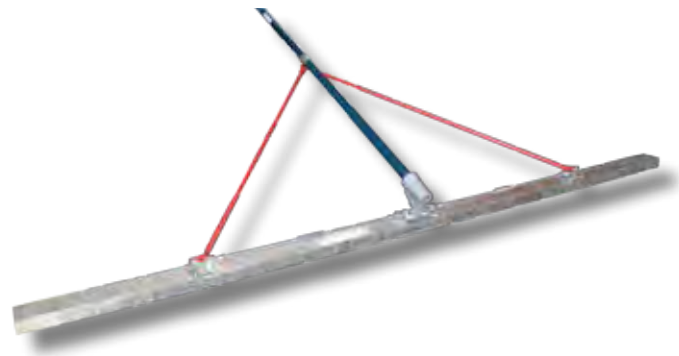

Bump Cutters



Super-Flat Bump Cutters cut bumps and fills low areas after the concrete slab has been floated. The tilt of the blade is adjustable and controlled by twisting the handle. This enables the operator to change the tilt of the blade (continuously if required) to achieve the optimum finish to the concrete. Handle not included with MF713.

Bronze Bullfloat Groover Bits					
Code	Description	Length	Width	Thickness	Barcode
MF713	Masterfinish Aluminium Bump Cutter	10' (3048mm)	4" (102mm)	2" (51mm)	765139619409
CC714	Kraft Magnesium Bump Cutter	10' (3048mm)	4" (102mm)	2" (51mm)	765139617146



Kraft Tilt Brackets



Kraft Tilt Brackets			
Code	Description	Fits	Barcode
CC280	Bronco Tilt	2 or 4 hole metal Bullfloats	765139612806
CC296	Knucklehead Bracket	2 or 4 hole metal Bullfloats	765139321593
CC294	Ezy Tilt II	2 or 4 hole metal Bullfloats	765139612943



CC296



CC294



CC280

Concrete Rollers



Depresses the aggregate and brings the fat to the surface in a uniform manner, preparing the surface for a smoother finish.

Concrete Rollers				
Code	Description	Diametre	Width	Barcode
MF1045	Solid Concrete Rollers	114mm	450mm	9318428315455
MF1046	Solid Concrete Rollers	114mm	600mm	9318428115603
MF1047	Solid Concrete Rollers	114mm	750mm	9318428315752



1045

Finishing Brooms



Timber brooms are made with high quality hair and fibre bristles. Made to fit 588 and 1076.

Aluminium brooms are made with high quality nylon bristles and are fitted with a 360 degree adjustable bracket. Bristles ranging from fine through to hard. Made to fit 588 and 1076, see page 27.

Finishing Brooms					
Code	Description	Length	Bristles	Colour	Barcode
1572	Hair and fibre bristle timber broom	600mm	Standard/Fine	Black	9318428295726
1573	Hair and fibre bristle timber broom	750mm	Standard/Fine	Black	9318428295733
1574	Hair and fibre bristle timber broom	900mm	Standard/Fine	Black	9318428295740
1974	Nylon bristle aluminium broom	900mm	Standard/Fine	Black	9318428291940
1974BLUE	Nylon bristle aluminium broom	900mm	Medium	Blue	9318428291957
1974GREEN	Nylon bristle aluminium broom	900mm	Hard	Green	9318428291964
1904Black	1974 replacement brush	900mm	Standard/Fine	Black	9318428101985
1904Blue	1974 replacement brush	900mm	Medium	Blue	9318428101942
1904Green	1974 replacement brush	900mm	Hard	Green	9318428101953

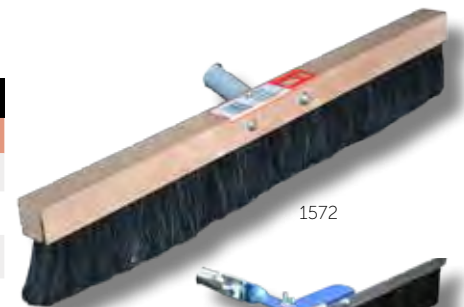

1572

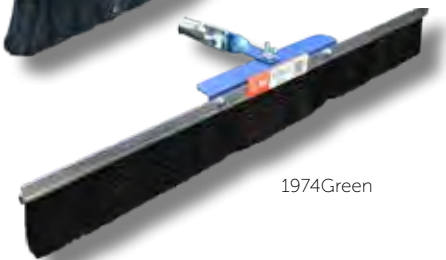

1974Green

Magnesium Asphalt Lute



Heavy-duty asphalt lute is available with standard teeth or no teeth. Made of genuine Extra-Lite Magnesium for longevity and strength. Used to ensure asphalt is applied evenly. Use smooth side for finishing.

Magnesium Asphalt Lute				
Code	Description	Diametre	Handle	Barcode
GG830	Asphalt Lute with Standard Teeth C/W Handle	30" (762mm)	7' (2.1m)	765139908305
GG836	Asphalt Lute with Standard Teeth C/W Handle	36" (914mm)	7' (2.1m)	765139908367
GG875	Asphalt Lute without Teeth C/W Handle	30" (762mm)	66" (1.7m)	765139452198



GG830



Exposed Aggregate Sprayer

Designed for washing exposed aggregate.



Aggregate Sprayer			
Code	Description	No. of Heads	Barcode
EAGGUN	Exposed AG Sprayer	4 Replaceable heads	9318428102536



Thickness Gauge

These self-adjusting gauge rakes have been used for many years. They allow you to achieve a reasonably level depth when installing more cementitious materials and move more easily over rougher surfaces.



Thickness Gauge				
Code	Description	Size	Made to fit	Barcode
TG600	Thickness Gauge	600mm	Timber Handles	9318428116007
TG1000	Thickness Gauge	1000mm	Timber Handles	9318428110005
CC975	Gauge Rake	24"-610mm	Kraft Timber Handle	765139310092
CC976	Gauge Rake	36"-914mm	Kraft Timber Handle	765139298321

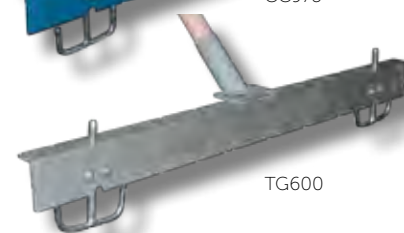

Stand Up Smoother

This tool is used in an upright position. The Stand Up Smoother maximises installation speed while being very user friendly. Used for smoothing floor levelling compounds. Use with RH timber handles, see page 27.



Stand Up Smoother			
Code	Description	Blade Length	Barcode
VT600	Carbon Steel Stand Up Smoother	600mm	9318428100563



Squeegees

All Neoprene squeegee blade. The perfect tool to smooth a variety of coatings in construction, drywall and concrete restoration. Use with RH timber handles, see page 27.



Squeegees			
Code	Description	Length	Barcode
GG236	Kraft Rubber Squeegee	900mm	765139327045
M335	Masterfinish Rubber Squeegee	600mm	9318428102529

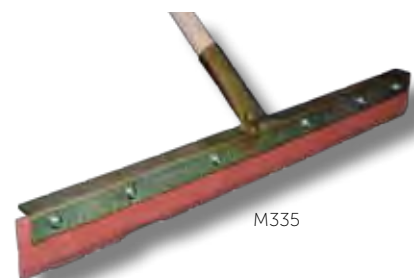

Concrete Roller Tamps

Diamond Patterned Safety Roller gives a rough, skid resistant finish to concrete ramps. Perfect for wheelchair or loading walkways where a non-skid surface is a must. Roller is 5" in diameter and made of tough expanded steel diamond mesh. Handle bracket accepts threaded 1-3/4" bullfloat extension handles. Fits CC289SB, CC291SB and CC293SB Kraft poles, see page 28.



Concrete Roller Tamps			
Code	Description	Length	Barcode
CC946	Single Roller Tamp	8" (203mm)	765139610031
CC948B	Roller Tamps	18" (457mm)	765139613780
CC952B	Roller Tamps	36" (914mm)	765139610857
CC958B	Roller Tamps	48" (1219mm)	765139613841



For Poles and Handles See Page 27-28

Kerb and Gutter Tools		
Code	Description	Barcode
KGT	Kerb and Gutter Profile Trowel	9318428221985
RK	Roll Kerb Trowel (Pair)	9318428102208
KGCT	Kerb and Gutter Crossing Trowel	9318428221978
KGC	Kerb Coving Trowel	9318428221954
SF	Splayed Kerb Tool	9318428222203
KGE	Kerb Nosing Trowel	9318428221930

Barrier kerb and gutter adjacent to footway

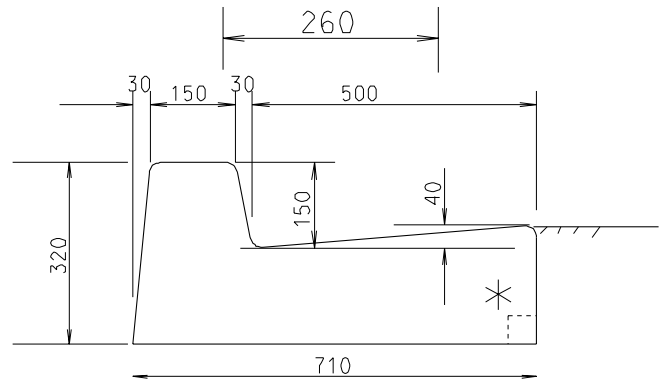

Urban. Allows verge/footway parking

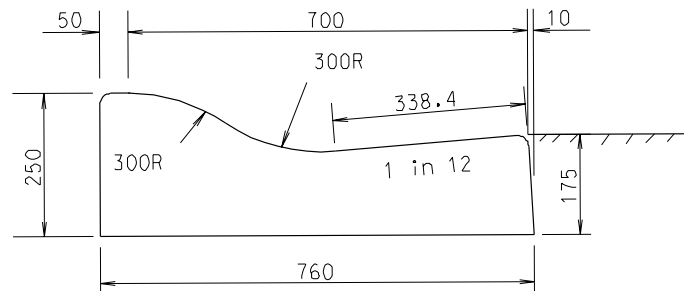

Raised median stripes and traffic islands

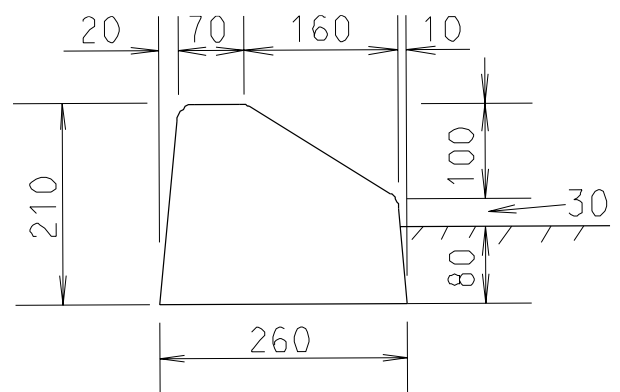

Footway crossfall

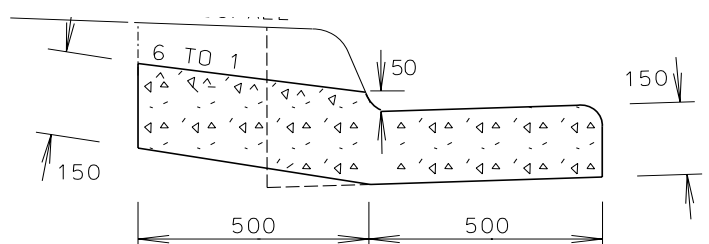

KGT

KGE



KGC

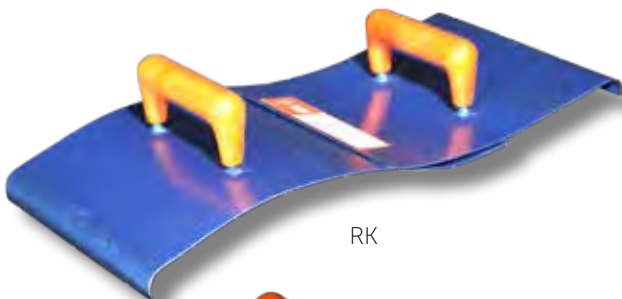

RK



SF



KGCT

Shovels



D handle steel shovels have a heavy-duty lightweight design and are made from recycled railway steel, making them very eco friendly.

Shovels				
Code	Description	Length	Pack Qty	Barcode
MFYSL	D Handle Steel Shovels	110cm	3	9318428101973



Dish Drain or Coving Tools



Used to form dish drains and coves in concrete.

Dish Drain or Coving Tools				
Code	Description	Radius	Width	Barcode
206	Semi Circle Trowel	50mm	105mm	9318428112061
466	Stainless Steel part ircle	75mm	125mm	9318428114669



Float Hook



Float hooks clip to belt. Holds hand floats and other tools.

Float Hook			
Code	Description	Pack Qty	Barcode
MF011	Float Hook	24	765139346015



Walking Tools

These are dedicated walking floats, edgers and jointers and are made to be used with either a 1076 or 1067 telescopic pole or a 588 clip handle. See page 27.

Walking Tools						
Code	Description	Length	Width	Depth	Radius	Barcode
700W	Carbon Steel Walking Edger	230mm	150mm	24mm	12mm	9318428147100
708W	Carbon Steel Walking Edger	200mm	140mm	19mm	20mm	9318428147117
302W	Carbon Steel Walking Vee Jointer	175mm	150mm	12mm	N/A	9318428123036
312W	Carbon Steel Walking Vee Jointer	175mm	150mm	20mm	N/A	9318428132135
219W	Carbon Steel Walking Float	150mm	380mm	N/A	N/A	9318428212198
209W	Stainless Steel Walking Float	160mm	210mm	N/A	N/A	9318428212099



312W

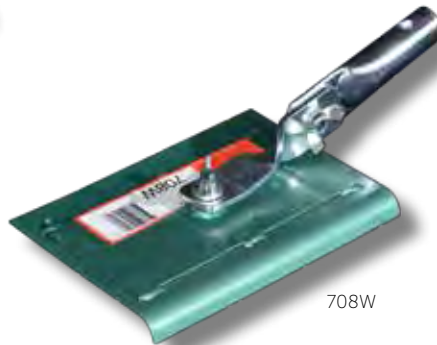

708W



219W

All Angle Walking Edger



Made of heavy gauge stainless steel, this tool is reinforced with an electrically welded back plate to which the all-angle attachment is fastened. No rivets, completely smooth face. Handle sold separately.

All Angle Stainless Steel Walking Edgers						
Code	Description	Length	Width	Radius	Lip	Barcode
CC125-01	All Angle Walking Edgers	10" (254mm)	6" (152mm)	1/2" (12mm)	5/8" (15mm)	765139619768
CC126-01	All Angle Walking Edgers	10" (254mm)	6" (152mm)	3/4" (19mm)	7/8" (22mm)	765139619751

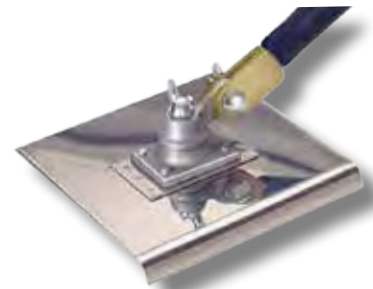

CC125

All Angle Walking Groover



Made with heavy gauge stainless steel and reinforced with an electrically welded back plate to which the all-angle attachment is fastened. Comes with 5' wood clevis handle (CC386).

All Angle Stainless Steel Walking Groovers						
Code	Description	Length	Width	Radius	Lip	Barcode
CC347	All Angle Walking Groover	8" (203mm)	6" (152mm)	1/4" (6mm)	1" (25mm)	765139619195
CC373	All Angle Walking Groover	10" (254mm)	3-1/2" (89mm)	3/8" (10mm)	1/2" (12mm)	765139615692

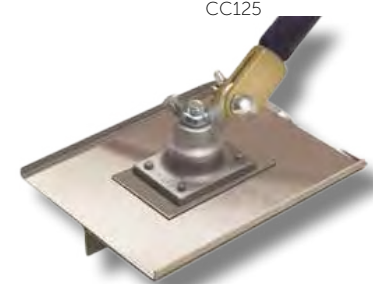

CC347

Decorative Plastic Tools



Special design for pool will not darken white coat. Heavy nose tool Plexiglas.

Decorative Plastic Tools						
Code	Description	Length	Width	Radius	Lip	Barcode
PL652	Plastic Step Tools	6" (152mm)	5" (127mm)	3/4" (19mm)	2-1/2" (63mm)	765139306521
PL653	Plastic Step Tools	6" (152mm)	5" (127mm)	1/2" (12mm)	2-1/2" (63mm)	765139306538
PL654	Plastic Step Tools	6" (152mm)	5" (127mm)	1-1/2" (38mm)	2-1/2" (63mm)	765139306545
PL655	Plastic Step Tools	6" (152mm)	5" (127mm)	3/4" (19mm)	5" (127mm)	765139306552
PL656	Plastic Step Tools	6" (152mm)	5" (127mm)	1/2" (12mm)	5" (127mm)	765139306569
PL657	Plastic Step Tools	6" (152mm)	5" (127mm)	1-1/2" (38mm)	5" (127mm)	765139306576



PL652

PL655

Magnesium Blade Floats



Used to produce a textured finish smoother than the wood float. A robust and long-wearing tool with a slightly curved or broken-in blade.

Masterfinish Magnesium Blade Floats				
Code	Description	Length	Width	Barcode
MF016PF	Masterfinish Mag Float	16" (406mm)	3-1/4" (83mm)	9318428100495
MF020PF	Masterfinish Mag Float	20" (508mm)	3-1/4" (83mm)	9318428100501



Kraft Magnesium Blade Floats				
Code	Description	Length	Width	Barcode
CF012PF	Magnesium Blade Float	12" (305mm)	3-1/4" (83mm)	765139310153
CF014PF	Magnesium Blade Float	14" (356mm)	3-1/4" (83mm)	765139309591
CF015PF	Extra Wide Mag Float	16" (406mm)	3-1/4" (83mm)	765139309591
CF016PF	Magnesium Blade Float	16" (406mm)	3-1/4" (83mm)	765139309560
CF018PF	Magnesium Blade Float	18" (457mm)	3-1/4" (83mm)	765139323948
CF020PF	Magnesium Blade Float	20" (508mm)	3-1/4" (83mm)	765139309577



Round End Magnesium Blade Floats

Magnesium blade float with rounded ends.

Magnesium Blade Floats				
Code	Description	Length	Width	Barcode
CF076PF	Kraft Round End Mag Float	16" (408mm)	3-1/4" (83mm)	765139309706



Mini Mag Float

Lightweight magnesium wall float. Great tool for floating in small areas, stairs or top of wall between forms. Fitted with a ProForm handle.

Mini Mag Float				
Code	Description	Length	Width	Barcode
CF663PF	Mini Mag Float W/PF HDL	7-1/2" (191mm)	3-1/4" (83mm)	765139348101



Stainless Steel Safety Step Edger

Cuts four grooves while edging the step. Grooves 3/4" on centre.

Stainless Steel Safety Step Edger				
Code	Description	Radius	Lip Depth	Barcode
CF112PF	Grooved Step Nosing	1/2" (12mm)	1/4" (6mm)	765139348101



Sidewalk & Highway Edger

Stainless steel edger with proform handle.

Sidewalk & Highway Edger				
Code	Description	Radius	Lip Depth	Barcode
CF137PF	Sidewalk & Highway Edger	1/4" (6mm)	3/8" (10mm)	765139340426
CF138PF	Sidewalk & Highway Edger	3/8" (10mm)	1/2" (12mm)	765139340440
CF175PF	Sidewalk & Highway Edger	1/2" (12mm)	5/8" (16mm)	765139341638



Stainless Steel Hand Groover

Special polished stainless steel for extra smooth working surface with turned up ends to prevent gouging.

Stainless Steel Hand Groover						
Code	Description	Width	Length	Radius	Depth	Barcode
CF599PF	Stainless Steel Hand Groover	6" (152mm)	6" (152mm)	1/4" (6mm)	3/8" (10mm)	765139347937



Carbon Steel Concrete Finishing Trowels



Guaranteed NO-TURN handle design locks handle to mounting. Each blade is cross ground to just the right dimension for that perfect feel; featuring a high-strength, lightweight aluminium mounting. Comfortable ProForm handle with contoured shape and an enhanced textured ribbing for a "GREAT GRIP".

Carbon Steel Finishing Trowels				
Code	Description	Length	Width	Barcode
CF207PF	Carbon Steel Finishing Trowel	11" (279mm)	4" (102mm)	765139304817
CF217PF	Carbon Steel Finishing Trowel	14" (356mm)	4" (102mm)	765139100242
CF219PF	Carbon Steel Finishing Trowel	14" (356mm)	4-3/4" (121mm)	765139100181
CF222PF	Carbon Steel Finishing Trowel	16" (406mm)	4" (102mm)	765139100259
CF227PF	Carbon Steel Finishing Trowel	18" (457mm)	4" (102mm)	765139100266
CF228PF	Carbon Steel Finishing Trowel	18" (457mm)	4-1/2" (114mm)	765139305616
CF232PF	Carbon Steel Finishing Trowel	20" (508mm)	5" (127mm)	765139100273
CF234PF	Carbon Steel Finishing Trowel	24" (610mm)	5" (127mm)	765139320893



CF217PF

Blue Steel Concrete Finishing Trowels



High quality blue steel blade with additional flexibility. Forged aluminium shank.

Blue Steel Finishing Trowels				
Code	Description	Length	Width	Barcode
CF731BPF	Blue Steel Finishing Trowel	14" (356mm)	4" (102mm)	765139308143
CF732BPF	Blue Steel Finishing Trowel	16" (406mm)	4" (102mm)	765139307214
CF729BPF	Blue Steel Finishing Trowel	18" (457mm)	4" (102mm)	765139326925
CF734BPF	Blue Steel Finishing Trowel	20" (508mm)	5" (127mm)	765139307269
CF735BPF	Blue Steel Finishing Trowel	24" (610mm)	5" (127mm)	765139321050



CF732BPF

Swedish Stainless Steel Concrete Finishing Trowels



High quality heat-treated Swedish stainless steel. Special alloy will not rust, pit or stain. Forged aluminium shank.

Swedish Stainless Steel Finishing Trowels				
Code	Description	Length	Width	Barcode
CF742PF	Stainless Steel Finishing Trowel	12" (305mm)	4" (102mm)	765139307399
CF744PF	Stainless Steel Finishing Trowel	14" (356mm)	4" (102mm)	765139307436



CF742PF

Golden Stainless Steel Concrete Finishing Trowels



Heat-treated golden stainless steel. Special alloy will not rust, pit, or stain. Forged aluminium shank.

Golden Stainless Steel Finishing Trowels				
Code	Description	Length	Width	Barcode
CF540PF	Golden Stainless Steel Finishing Trowel	14" (356mm)	4-3/4" (121mm)	765139605389
CF549PF	Golden Stainless Steel Finishing Trowel	20" (508mm)	5" (127mm)	765139321258

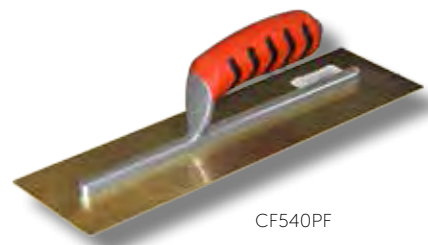

CF540PF

Carbon Steel Midget Trowel



Great for window sills, closets and small areas. Carry one in your tool bag for those tough-to-reach jobs.

Midget Trowel				
Code	Description	Length	Width	Barcode
PL407PF	Kraft Carbon Steel Midget Trowel	8" (203mm)	3" (76mm)	765139307634



Pool Trowels



Forged aluminium shanks. The longer shank creates more stability in the trowel blade whereas a small shank will allow for more flexibility. Rounded edges prevent surface gouging.

Pool Trowels					
Code	Description	Length	Width	Shank	Barcode
CF272BPF	Blue Steel Short Shank Pool Trowel	14" (356mm)	3" (76mm)	6" (152mm)	765139306071
CF274BPF	Blue Steel Short Shank Pool Trowel	10" (254mm)	3" (76mm)	3" (76mm)	765139306170
CF276BPF	Blue Steel Short Shank Pool Trowel	12" (305mm)	3-1/2" (88mm)	4-3/8" (111mm)	765139306286
CF277BPF	Blue Steel Short Shank Pool Trowel	14" (356mm)	4" (102mm)	6" (152mm)	765139100389
CF279BPF	Blue Steel Short Shank Pool Trowel	16" (406mm)	4" (102mm)	7-5/8" (194mm)	765139100396
CF292BPF	Blue Steel Short Shank Pool Trowel	18" (457mm)	5" (127mm)	9-5/8" (244mm)	765139306408
CF295BPF	Blue Steel Short Shank Pool Trowel	20" (508mm)	5" (127mm)	11-5/8" (295mm)	765139100402
CF745BPF	Blue Steel Long Shank Pool Trowel	24" (610mm)	4" (102mm)	15-5/8" (397mm)	765139321395
CF746BPF	Blue Steel Long Shank Pool Trowel	24" (610mm)	5" (127mm)	15-5/8" (397mm)	765139321456
CF274PF	Golden Steel Pool Trowel	10" (254mm)	3" (76mm)	3" (76mm)	765139100471
CF276PF	Golden Steel Pool Trowel	12" (305mm)	3-1/2" (88mm)	4-3/8" (111mm)	765139100488
CF277PF	Golden Steel Pool Trowel	14" (356mm)	4" (102mm)	6" (152mm)	765139100501
CF279PF	Golden Steel Pool Trowel	16" (406mm)	4" (102mm)	7-5/8" (193mm)	765139100495



CF274PF



CF276PF

Chrome (No Burn) Pool Trowels



High quality blue steel. 3" rounded narrow blade with long shank. Allows finishers to apply pressure for a smooth, hard finish.

Chrome Pool Trowels					
Code	Description	Length	Width	Shank	Barcode
CF490PF	Chrome (no burn) Pool Trowel	10" (254mm)	3" (76mm)	3-1/2" (88mm)	765139306798
CF493PF	Chrome (no burn) Pool Trowel	14" (356mm)	4" (102mm)	6" (152mm)	765139306873



CF490PF

Carbon Steel Pipe Trowel



Finish hard-to-get places in half the time with half the effort. The offset handle lets you slip the trowel between pipes. The long nose makes it easy to get behind fixtures.

Pipe Trowel				
Code	Description	Length	Width	Barcode
PL501PF	Kraft Carbon Steel Pipe Trowel	10-1/2" (267mm)	3" (76mm)	765139307962



Kraft Elite Concrete Finishing Trowels



The Elite Series Five Star Trowel is designed and engineered for the professional finisher. These professional trowels are manufactured with state of the art machinery that precisely grinds the working surface of each individual trowel. This innovative procedure enables these trowels to possess a truly "broken-in" blade ready for immediate use. The Elite Series is fitted with the soft ProForm handle.

Elite Trowels				
Code	Description	Length	Width	Barcode
CFE534PF	Kraft Elite SS Trowel	14" (356mm)	5" (127mm)	765139436464
CFE543PF	Kraft Elite Golden SS Trowel	14" (356mm)	5" (127mm)	765139436525
PLE457PF	Elite SS Trowel	11-1/2" (292mm)	4-3/4" (120mm)	765139436983



CFE534PF

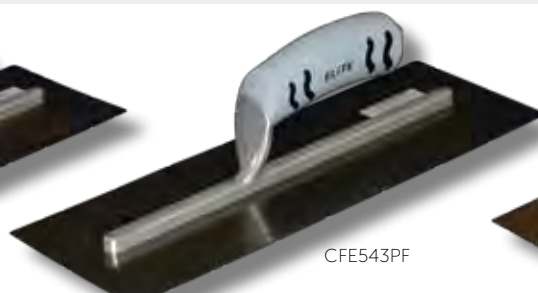

CFE543PF



PLE457PF

Floor Scrapers

Cleans and shaves all types of material from concrete and wood surfaces. Great for concrete form cleaning. Built with an all steel construction and is fitted with spring steel blades and T-grip handles.

Floor Scraper				
Code	Description	Blade size	Pack Qty	Barcode
LHS	Long Handle Floor scraper	190mm	3	9318428221459
FS150	Floor scraper	150mm	3	9318428221428
FS200	Floor scraper	200mm	3	9318428101713
FS300	Floor scraper	300mm	3	9318428221466

Replacement Floor Scraper Blades			
Code	Description	Blade size	Barcode
LHS B7	Replacement blade for LHS	190mm	9318428221435
FS150B	Replacement blade for FS150	150mm	9318428221442
FS200B	Replacement blade for FS200	200mm	765139612141
FS300B	Replacement blade for FS300	300mm	765139612189



Concrete Rakes

Rakes and placers have a variety of applications and some are dual purpose. The MasterFinish aluminium placer rakes come in 3 styles - push, pull and double-sided. These well-constructed rakes make spreading concrete easier.

Concrete Rakes				
Code	Description	Length	Width	Barcode
MF999	Aluminium concrete rake with profile for pulling concrete	500mm	100mm	9318428101577
MF965	Aluminium concrete rake with a formwork hook and profile for pushing concrete	500mm	110mm	9318428109658
R600R	Aluminium concrete rake with profile for both pushing and pulling concrete	500mm	100mm	9318428100723
R500	Rake head for alum or timber handles	480mm	120mm	9318428215007
R500H	Rake head with steel finger for alum or timber handles	480mm	120mm	9318428215014
MFR500	Aluminium concrete rake with a profile for pushing	500mm	110mm	9318428122284
CC010	Kraft concrete rake with a timber handle	22-1/2"	5"	765139322668
CC113	Kraft Magnesium concrete rake with a handle	19-1/2"	4"	765139322767



Handtools

Gauge Trowels

Carbon steel blade is ground for flexibility. Perfect for mixing or transferring material. Fitted with a soft grip handle.



Gauge Trowels				
Code	Description	Length	Width	Barcode
T963-7	Gauging Trowel	178mm	85mm	9318428100310
T963-8	Gauging Trowel	203mm	90mm	9318428100327



T963-7

Pointing Trowel

Blade is made of tempered steel, taper ground and fitted with a soft grip handle.



Pointing Trowel		
Code	Description	Barcode
T960-6	Pointing Trowel	9318428100334



T960-6

V Sled Runners



The best tool you can get for making round, sunken concave or rodded masonry joints. Made with high quality steel blades.

V Sled Runners				
Code	Description	Length	Width	Barcode
BL214PF	V Sled Runner	14" (356mm)	3/4" (19mm)	765139348125
BL220PF	V Sled Runner	20" (508mm)	3/4" (19mm)	765139348163



BL214PF

Brick Jointers



Each end makes a different size concave joint. Overall length 10-1/2".

Brick Jointers				
Code	Description	Width 1	Width 2	Barcode
BL260	Brick Jointer	3/8" (10mm)	1/2" (12mm)	765139102604
BL261	Brick Jointer	1/2" (12mm)	5/8" (16mm)	765139102611
BL262	Brick Jointer	5/8" (16mm)	3/4" (19mm)	765139102628
BL264	Brick Jointer	3/4" (19mm)	7/8" (22mm)	765139102642
BL265	Brick Jointer	7/8" (22mm)	1" (25mm)	765139102659



BL260

Skate Wheel Joint Raker



Masons love this big-wheeled joint raker. Wheels are 1-3/4" in diameter, mounted 2-1/4" apart. Overall width is 3-5/8". Has 8-1/2" aluminum handle that is squared off at the end so you can rod joints. Hardened nail can be adjusted to different depths.

Skate Wheel Joint Raker				
Code	Description	Length	Width	Barcode
BL210	Skate Wheel Joint Raker	8-1/2" (216mm)	3" (76mm)	765139102109



BL210

HAND-FORGED STEEL BLADES

W. ROSE™ TOOLS ENDURE

PROUDLY MADE
IN THE USA
SINCE 1798



FORGED STEEL

The blade and shank are forged from a single piece of uniquely formulated carbon steel for extra toughness. Forging also assures product consistency.

HANDLE STYLES

Four styles of handles are available on most W. Rose™ trowels - ProForm® soft grip, leather, two sizes of wood and plastic. All handles are specially contoured for a comfortable grip. Replacement handles are also available.

FLEXIBILITY

W. Rose™ features a tapered ground blade for flexibility. Blades are made available in standard or limber weights as desired by the mason.

HEAT TEMPERED

Blades are heat tempered with a special time-tested process to ensure uniform blade hardness.

STRENGTH

The forged steel blade and shank offer strength and integrity with no internal voids created by welding pieces together. Forged steel will not weaken or crack under use or impact as welded tools may.

SHANK ANGLE

The angle of the standard shank is specially balanced to reduce wrist fatigue. Many of our popular trowel patterns are also available in low lift shanks as some masons may prefer.

INSPECTION

Every trowel is inspected visually by experienced workers, keeping in mind the high quality standards of the W. Rose™ legacy. They are also tested for blade hardness and size consistency.

HAND POLISHED

Each blade is carefully hand polished to keep mortar centered on the blade and resist sliding.

W. Rose Brick Trowel						
Code	Description	Length	Width	Shoulder Style	Pack Qty	Barcode
RO110-12SH	Rose Philadelphia Brick Trowel	12" (305mm)	5-9/16" (141mm)	Square	6	765139319903
RO112-12SH	Rose London Brick Trowel	12" (305mm)	5-13/16" (147mm)	Round	6	765139310757
RO310-12	Rose Philadelphia Brick Trowel Leather Handle	12" (305mm)	5-9/16" (141mm)	Square	6	765139700558
RO312-12	Rose London Brick Trowel Leather Handle	12" (305mm)	5-13/16" (147mm)	Round	6	765139700626
RO116-13SH	Rose Narrow London Brick Trowel	13" (330mm)	5-3/8" (137mm)	Round	6	765139311075



Brick Trowel



One-piece forging made from the highest grade trowel steel. Taper ground for flexibility.

Brick Trowel					
Code	Description	Length	Width	Barcode	
T967-L12	Masterfinish Brick Trowel London Pattern	12" (305mm)	5-13/16" (148mm)	9318428100341	



T967-L12

Mason Hammer



BL324 - Built to really take punishment. Rugged steel handle will not break, fly off, dent or get chewed up. Exceptionally well balanced.

BL353 - Made of steel with nylon-vinyl cushion grip. Polished face and bevel, painted finish.

Mason Hammer				
Code	Description	Weight	Barcode	
BL324	Mason Hammer	24oz	765139103243	
BL353	One-Piece Estwing Mash Hammer	3lbs	765139103533	



BL324



BL353

Jumbo Utility Brush



This red handled utility brush is a must for any professional. Long-wearing, white tampico fibers can be used on masonry, brick, tile and stone. A truly versatile brush.

Jumbo Utility Brush					
Code	Description	Length	Width	Barcode	
BL526	Jumbo Utility Brush	6-1/2" (165mm)	2" (50mm)	765139105261	



BL526

Heavy-Duty Trestles



Easymix heavy-duty trestles are made from tubular galvanised steel and are certified to Australian standards as per AS/NZS 156.5:1995 Scaffolding - Prefabricated splitheads and trestles.

Heavy-Duty Trestles					
Code	Description	Height	Width	Collapsible	Barcode
BT700	Easymix Brick Trestles	700mm	960mm	Yes	931842812420
BT950	Easymix Brick Trestles	950mm	960mm	Yes	9318428102437



BT700

For Mixers



See Page 89-92

Brick Profile Pole

Mastefinish Profile Poles are perfect for guague birck alignment, made from Galvanised steel with precies, fine, marchined markings which will not wear out. Two sided markings make the profile reversible.

Mason Hammer					
Code	Description	Width	Length	Brick Size	Barcode
MFPP	Galvanised Steel Profile Pole	40mm	2830mm	85mm	9318428104745



Brick Profile Steady

Mastefinish Profile Steady are designed to keep the profile pole perfectly steady during construction

Mason Hammer					
Code	Description	Width	Minimum Height	Maximum Height	Barcode
MFPS	Galvanised Steel Profile Pole Steady	20mm	2830mm	85mm	9318428104745



Square Trowels



Used where the pointed end trowel is not suitable e.g. finishing stair toppings and kerb & gutters.

Square Trowel						
Code	Description	Length	Width	Gauge	Pack Qty	Barcode
450S120	Carbon Steel Square Trowel	450mm	120mm	Light	6	9318428104509
500S120	Carbon Steel Square Trowel	500mm	120mm	Light	6	9318428105001
600S120	Carbon Steel Square Trowel	600mm	120mm	Light	6	9318428106008
350S150	Carbon Steel Square Trowel	350mm	150mm	Light	6	9318428103502
400S150	Carbon Steel Square Trowel	400mm	150mm	Light	6	9318428104004
PP73	Carbon Steel Square Trowel	365mm	120mm	Light	6	9318428100730



PP73

Plasterer's Hawk



Plasterer's hawks are made with a light but tough aluminium plate, a screw in plastic handle and a sponge hand cushion.

Plasterer's Hawks			
Code	Description	Width	Barcode
1038	MF Aluminium Plasterer's Hawk	300mm	9318428181388
1039	MF Aluminium Plasterer's Hawk	330mm	9318428181395
1040	MF Aluminium Plasterer's Hawk	400mm	9318428181401
PL510PF	Kraft Aluminium Hawk	10" (254mm)	765139344523
PL512PF	Kraft Aluminium Hawk W/PF HDL	12" (305mm)	765139344530
PL513PF	Kraft Aluminium Hawk W/PF HDL	13" (330mm)	765139344547
PL263PF	Kraft Magnesium Hawk W/PF HDL	13" (330mm)	765139333190
PL265PF	Kraft Magnesium Hawk W/PF HDL	14" (356mm)	765139333213
PL266PF	Kraft Magnesium Hawk W/PF HDL	16" (406mm)	765139333237



1038

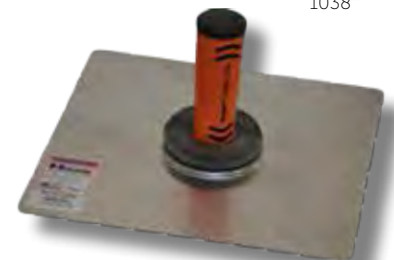

PL513PF

Kraft Drywall Trowels



Trowels are made of heat-treated steel. This special alloy will not rust, pit or stain. A great, long-wearing tool with just the right balance.

Kraft Drywall Trowels				
Code	Description	Length	Width	Barcode
PL447PF	Kraft Carbon Steel Drywall Trowel	11" (279mm)	4-3/4" (121mm)	765139304770
PL547PF	Kraft Stainless Steel Drywall Trowel	11" (279mm)	4-3/4" (121mm)	765139304732
PL455PF	Kraft Golden S/S Drywall trowel	11" (279mm)	4-3/4" (121mm)	765139307825



PL447PF



PL547PF



PL455PF

Poly Floats

Masterfinish Poly Floats are a single piece mould and made from high quality polyurethane. Perfect for rendering and finishing.



Poly Floats					
Code	Description	Length	Width	Thickness	Barcode
T1901-280	Poly Float	280mm	140mm	15mm	9318428100464
T1901-400	Poly Float	400mm	140mm	15mm	9318428100471



T1901-280

Plasterer's Square

Used in conjunction with a straight edge to scrape a corner and can be locked at the desired angle and depth.



Plasterer's Square		
Code	Description	Barcode
1035	Plasterer's Square	9318428181357



1035

Plasterer's Nosing

Plasterer's internal and external corner tools have a stainless steel blade formed to the traditional pencil round.



Plasterer's Nosing		
Code	Description	Barcode
1020	Stainless Steel Plasterer's External Edging Tool	9318428181029
1030	Stainless Steel Plasterer's External Edging Tool	9318428181234
1033	Stainless Steel Plasterer's Internal Edging Tool	9318428181333



1030



1033

Sponge Floats

1155 Sponge foam float features a lightweight plastic handle and aluminium backing plate.

1156 Foam float has the additional feature of a perforated aluminium backing plate for ease of cleaning the foam after use.



Sponge Floats				
Code	Description	Length	Width	Barcode
1155	Sponge Foam Float	325mm	135mm	9318428181159
1155R	Replacement foam for 1155	325mm	135mm	9318428181142
1156	Foam Float with perforated back plate	325mm	135mm	9318428181166
T876-280	Titan Rubber Sponge Float	280mm	140mm	9318428100457

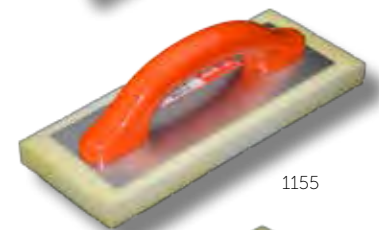

1155



1156

Featheredger

The magnesium alloy is lightweight and long wearing. "h" extrusion allows for comfortable finger grip. Tool pitch is controlled with thumb and palm. Used in the plastering trade to plane the brown coat and square up the inside corner angles.



Featheredger			
Code	Description	Spike Length	Barcode
PC004	Magnesium Featheredge	4Ft (1.2m)	765139310047
PC006	Magnesium Featheredge	6Ft (1.8m)	765139310061
PC007	Magnesium Featheredge	7Ft (2.1m)	765139310078
PC008	Magnesium Featheredge	8Ft (2.4)	765139310085

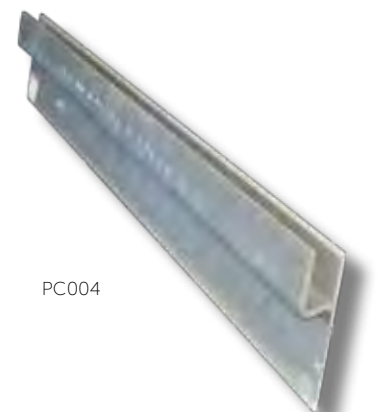

PC004

Starrett Hacksaw



Features a high-tension heavy-duty hacksaw frame with a closed comfort grip and efficient adjustment lever making it easy to use. The handle is covered by rubber overmold for a comfortable grip.

Starrett Hacksaw			
Code	Description	Blade Size	Barcode
KI45	High-Tension Hacksaw	300mm	7891265678188



Tape Measures



Our measuring tapes and measure Stix are offered in a wide range of styles and sizes. Graduations are available in English and metric to meet virtually every requirement for an accurate tape measurement. Introducing the new series of Starrett, Starrett Exact and Starrett Exact Plus.

Starrett Tape Measures				
Code	Description	Blade Size	Length	Barcode
KTS1-8M-N	Tape Measure	1"	8m	049659306675
KTX1-8M-N	Exact Tape Measure	1"	8m	049656306569
KTXP106-8M-N	Exact Plus Tape Measure	1.06"	8m	049656306408
KTS538-15M-N	Fibreglass Metric Long Tape	1/2"	15m	049659306101
KTS538-30M-N	Fibreglass Metric Long Tape	1/2"	30m	049656306149
KTXP511-30M-N	Metal Body Metric Long Tape- Fast Rewind	1/2"	30m	049659306002
KTS537-100M-N	Mega Tape Measure	1/2"	100m	049659306262



Chalk Line



Our chalk lines are produced with high impact-resistant cases. The chalk line is secured with a stainless steel hook.

Starrett Chalk Lines				
Code	Description	Length	Size	Barcode
KCS001-N	Chalk Line	30m	4oz	049659307337
KCX001-N	Exact Chalk Line	30m	4oz	049659307313
KCXP005-N	Exact Plus Chalk Line	30m	4oz	049659307306
KCXP001-N	Chalk Box	45m	14oz	049659307290



KCS001-N



KCX001-N



KCXP005-N



KCXP001-N

Replacement Chalk



Starrett Chalk Replacement				
Code	Description	Colour	Size	Barcode
SC8B	Chalk Refill	Blue	226g	049659631463
SC8O	Chalk Refill	Orange	226g	049659674552
SC8R	Chalk Refill	Red	226g	049659631470
SC8W	Chalk Refill	White	226g	049659631487
SC4Blue	Chalk Refill	Blue	1.8KG	049659000474
SC4ORG	Chalk Refill	Orange	1.8KG	049659000504
SC4RED	Chalk Refill	Red	1.8KG	049659000481
SC4WHT	Chalk Refill	White	1.8KG	049659000498



SC8R

SC4RED

Knives



A whole new line of utility knives to suit the cutting needs of mechanics, carpenters, maintenance workers and do-it-yourself. We have the utility knife for your needs.

Starrett Knives			
Code	Description	Blade Size	Barcode
KUS045-N	Large Plastic Slide Locking Utility Knife	18mm	049659307436
KUXP010-N	Aluminium Die-Cast Body Folding Utility Knife	18mm	049659307368



KUS045-N



KUXP010-N

Replacement Blades



Starrett Replacement Blades			
Code	Description	Blade Size	Barcode
KS06R	10 High Carbon Steel Break-away Blades	Break-away 18mm	7891265617866
KS01R	10 High Carbon Steel Trapezoidal Blades	Standard Trapezoidal	7891265617767



KS06R



KS01R

Clamp Handle Screed



'Clamp-on' style handle, which may be reversed to the working face for second use. Fitted with end plugs and powder-coated for ease of clean up. Australia's Original No.1 Selling Screed.

Screeds			
Code	Description	Length	Barcode
C12	Aluminium Concrete Screed	1200mm	9318428193121
C15	Aluminium Concrete Screed	1500mm	9318428193152
C18	Aluminium Concrete Screed	1800mm	9318428193183
C21	Aluminium Concrete Screed	2100mm	9318428193213
C24	Aluminium Concrete Screed	2400mm	9318428193244
C27	Aluminium Concrete Screed	2700mm	9318428193275
C30	Aluminium Concrete Screed	3000mm	9318428193305
C36	Aluminium Concrete Screed	3600mm	9318428193367
C12L	Aluminium Concrete Screed W/Level	1200mm	9318428194128
C15L	Aluminium Concrete Screed W/level	1500mm	9318428194159
C18L	Aluminium Concrete Screed W/level	1800mm	9318428194180
C21L	Aluminium Concrete Screed W/level	2100mm	9318428194210
C24L	Aluminium Concrete Screed W/level	2400mm	9318428194241
C27L	Aluminium Concrete Screed W/level	2700mm	9318428194272
C30L	Aluminium Concrete Screed W/level	3000mm	9318428194302
C36L	Aluminium Concrete Screed W/level	3600mm	9318428194364
1080H	Screed Handle	N/A	9318428191080
LVH	Screed Handle W/Level	N/A	9318428102598
C Plug	End plug for C screed	N/A	9318428193114
1080C-2 Pack	2 Screed clamps	N/A	9318428191080



Straight Edge



Light-weight accurate straight edge - measures 70x19. Uses include ruling cement render, tilting and as a general construction straight edge. Fitted with end plugs and powder-coated for ease of clean up, or in mill finish.

Straight Edges			
Code	Description	Length	Barcode
P12	Aluminium Straight Edge	1200mm	9318428199123
P15	Aluminium Straight Edge	1500mm	9318428199154
P18	Aluminium Straight Edge	1800mm	9318428199185
P21	Aluminium Straight Edge	2100mm	9318428199215
P24	Aluminium Straight Edge	2400mm	9318428199246
P27	Aluminium Straight Edge	2700mm	9318428199277
P30	Aluminium Straight Edge	3000mm	9318428199307
P36	Aluminium Straight Edge	3600mm	9318428199369
P12P	Plain Alum. Straight Edge	1200mm	9318428198126
P15P	Plain Alum. Straight Edge	1500mm	9318428198157
P18P	Plain Alum. Straight Edge	1800mm	9318428198188
P21P	Plain Alum. Straight Edge	2100mm	9318428198218
P24P	Plain Alum. Straight Edge	2400mm	9318428198249
P27P	Plain Alum. Straight Edge	2700mm	9318428198270
P30P	Plain Alum. Straight Edge	3000mm	9318428198300
P36P	Plain Alum. Straight Edge	3600mm	9318428198362
P Plug	Straight Edge End Plug	N/A	9318428199116

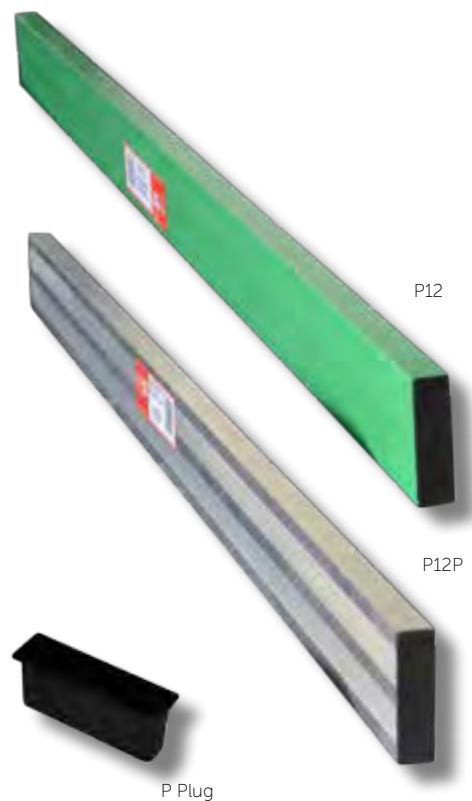

Fixed Handle Screeds - Available in Queensland Only



Traditional 50x36mm aluminium box section with one radius and one sharp cutting edge. The handle is fixed to the top of the screed. Fitted with end plugs and powder-coated for ease of clean up.

Screeds			
Code	Description	Length	Barcode
F12	Aluminium Fixed Handle Screed	1200mm	9318428196122
F15	Aluminium Fixed Handle Screed	1500mm	9318428196153
F18	Aluminium Fixed Handle Screed	1800mm	9318428196184
F21	Aluminium Fixed Handle Screed	2100mm	9318428196214
F24	Aluminium Fixed Handle Screed	2400mm	9318428196245
F27	Aluminium Fixed Handle Screed	2700mm	9318428196276
F30	Aluminium Fixed Handle Screed	3000mm	9318428196306
F36	Aluminium Fixed Handle Screed	3600mm	9318428196368
F Plug	End Plug for F Screed	N/A	9318428196115

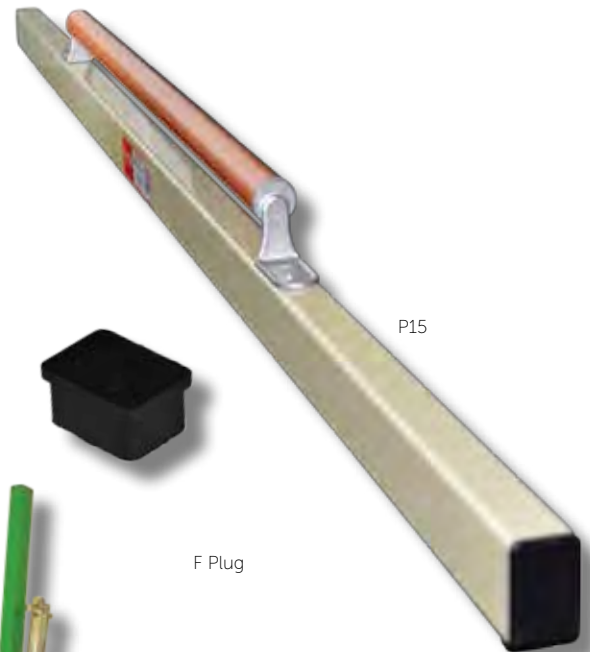

The Original Screed Stand



SCREEDSTAND

See Page 109

Masterfinish Poles

1076 - 1067

Widely used for many floating and finishing jobs, enabling the work to be achieved from a standing position, external from the concrete slab.

The inside tube is grooved. A pin penetrates this groove. This allows the twisting action the operator applies to the handle to be transferred to the floor. The handle length is locked by lightly twisting the collet nut. The 1076 can extend from 2.75 to 5m and the 1067 can extend from 1.23m to 2.43m.

The handle also features removable clip-on steel tube adaptor (part No. 1076E). This allows the operator to unclip the handle from the tool for cleaning, storage or to fit to another tool. Additional adaptor tubes (1076E) may be purchased.

1086

Used as an extension for the 1076 pole. A 1076 is inserted into the 1086 which is held in place by the collet fitting. Enables telescopic the extend from 2.80m to 7m. 1076 is not included.

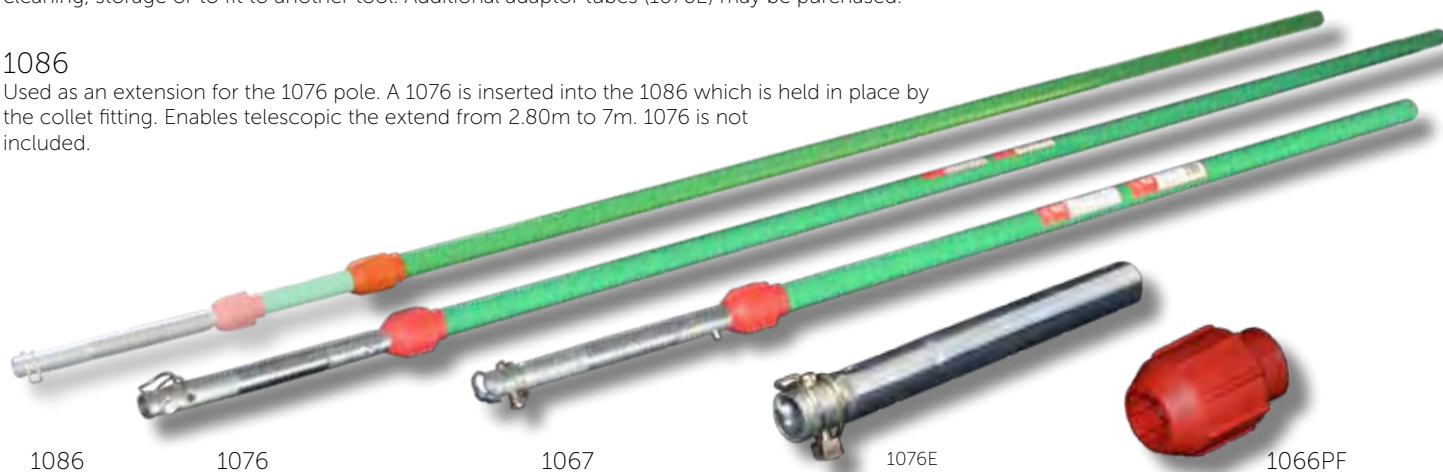

588

The aluminium tube is fluted to enhance grip. The inserted end tube is zinc plated steel, swaged down to fit neatly on the shaft of a bullfloat, walking trowel, or broom bracket.

Three or four of these handles may be aligned together to give a reach of 6 to 8 metres. To obtain a 7m reach, a 588 clip handle can be clipped onto the 1076 telescopic handle.

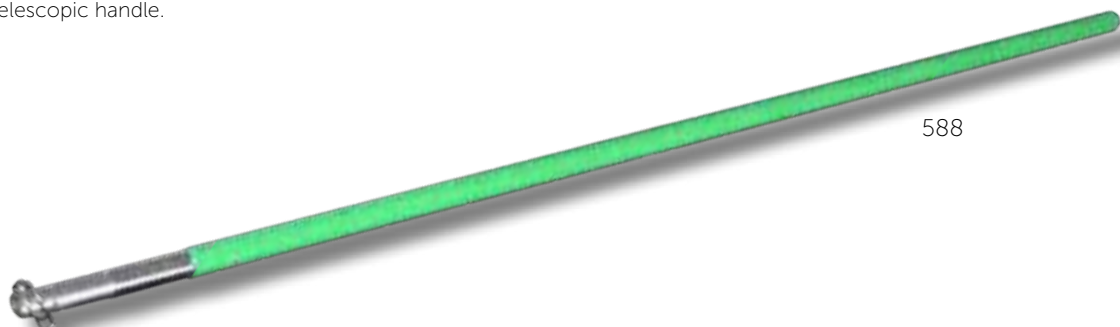

RH

The Masterfinish 1.8m timber Rake Handle fits a range of Masterfinish products where a 588 or 1076 are not applicable.



Poles			
Code	Description	Length	Barcode
588	Multi Fit Clip Handle	2m	9318428215588
1067	Telescopic Handle Half Length	1.32m to 2.43m	9318428101546
1076	Telescopic Handle	2.75m to 5m	9318428211665
1086	Telescopic Handle Extension	2.80m to 7m	9318428651478
1076E	Swaged Adaptor	N/A	9318428211108
1066FP	Plastic Collet Fitting	N/A	9318428211085
1076P-4	4 Pack 1076 Pin & Clamp	N/A	931842899340
1076S-4	4 Pack Spring Clips	N/A	931842899357
RH	Masterfinish Timber Handle	1.8m	9318428215021



Kraft Poles



CC289SB - CC291SB - CC293SB

Swaged handles are anodized aluminium which prevents hands turning black from oxidation. Lightweight aluminium button handles for use with Kraft double tilt action float brackets. Available in a range of sizes: CC289SB - 1.8m, CC293SB - 2.4m and CC291SB - 3m. Handles have a diameter of 1-3/4".



CC289SB

CC336B

1.8m swaged handles are anodized aluminium which prevents hands turning black from oxidation. Handles can be adapted for use on bullfloats, fresnos, and all long handle type construction tools. Swaged ends nest and snap together with spring lock buttons. Handle has a diameter of 1-3/4".



CC336

CC266

1.8m Kraft wood handle for a longer reach while using Kraft bronze and stainless steel hand tools.



CC266

Poles			
Code	Description	Length	Barcode
CC289SB	Kraft Aluminum Button Handle	6ft (1.8m)	765139334227
CC291SB	Kraft Aluminum Button Handle	10ft (3m)	765139351170
CC293SB	Kraft Aluminum Button Handle	8ft (2.4m)	765139351217
CC336B	Clip Handle	6ft (1.8m)	765139326161
CC266	Kraft Wooden Handle	6ft (1.8m)	765139612660

Handtools

Rub Bricks



Fluted silicon carbide rub bricks with a contoured handle to minimize fatigue. Preferred by finishers for fast and easy concrete smoothing and dressing down.

Carborundum Rubbing Brick				
Code	Description	Length	Thickness	Barcode
CF270	20 Grit Round Rub Brick	6"-152mm	1"-25mm	765139602708
CF282	60 Grit Rub Brick	6"-152mm	3"-76mm	765139602821
CF283	20 Grit Rub Brick	6"-152mm	3"-76mm	765139602838



CF282



CF270

Adhesive Spreaders



QTF has a 10mm square tooth for applications requiring a thick bed of adhesive such as quarry tiles.

QTF 2 has a 6mm saw tooth for areas where less adhesive is required.

Adhesive Spreaders				
Code	Description	Tooth Style	Thickness	Barcode
QTF	Carbon Steel Adhesive Spreaders	10mm square tooth	1.6mm	9318428222005
QTF 2	Carbon Steel Adhesive Spreaders	6mm saw tooth	1.6mm	9318428222029

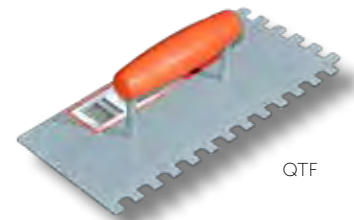

QTF

Mixer Paddles



Mixer paddles are designed to mix a wide variety of materials from paint to cement.

Mixer Paddles				
Code	Description	Diameter	Length	Barcode
DC363	Unomixer	3-1/4"-83mm	16"-406mm	765139513639
DC408	Jiffymixer	2-5/8"-67mm	10-1/2"-266mm	765139514087
MIXER	Mixer Paddles	120mm	600mm	9318428199253

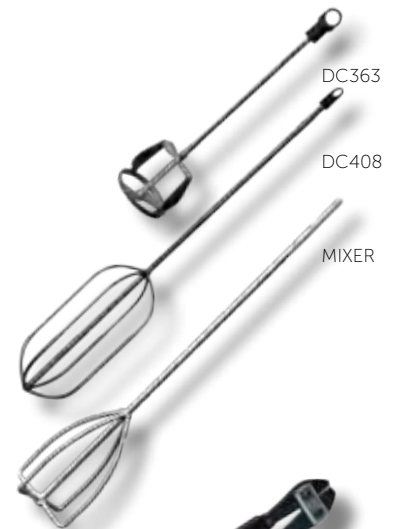

DC363

DC408

MIXER

MCC Handy Cutters



Easy one hand cutting with superior performance and durability. Blade opening is adjustable. For more of the MCC range see page 101.

Hand Held Cutters					
Code	Description	Size	Max Capacity/ Metal Hardness	Weight	Barcode
MC-0020	Midget Cutter	210mm	4.0 for Soft 80 HRB	280g	9318428199260
SC-0200	Strap Cutter	240mm	32 x 0.9	300g	9318428199284
ASR-0101	Aviation Snip	225mm	0.6 Tin Plate	270g	9318428199291
MU-0020	All Purpose Snip	210mm	0.8 Tin Plate	220g	931842899319



MC-0020

SC-0200

ASR-0101

MU-0020

Ratchet Wrenches



Drop-forged from special alloy steel with chrome molybdenum insert. Features silver green finish. Ideal for construction workers. Each wrench has two sizes and a reversible ratchet with a press of thumb. Tapered handle is also used to align holes for bolts and nuts.

Ratchet Wrenches					
Code	Description	Socket Size	Size	Weight	Barcode
RW-1921	Double Socket Ratchet Wrench	19x21mm	312mm	0.45kgs	931842899326
RW-1924	Double Socket Ratchet Wrench	19x24mm	355mm	0.70kgs	931842899333



RW-1921

Dirt Tamper



Ideal for tamping texture mats and achieving the right amount of pressure on each mat. Poly-coated base prevents tearing or marring of texture mats. Heavy-duty cast iron tampers fitted with 48" hardwood handle.

Dirt Tamper			
Code	Description	Length	Barcode
CC926	Dirt Tamper	10" (254mm)	765139619263



CC926

GG630-56

Pry Bar



All purpose tool ideal for prying formwork and other construction jobs. Specially designed 3" wide blade angle and hardened steel claw make for easy prying.

Kraft Pry bars			
Code	Description	Length	Barcode
GG630-56	Big John Heavy Duty Pry Bar	56" (1422mm)	765139906301
GG631-46	Little John Pry Bar	46" (1168mm)	765139345704

Yellow Cell Sponge



Durable cellulose keeps its shape. Great for cleaning and all around use.

Sponge					
Code	Description	Length	Width	Thickness	Barcode
PL370	Kraft Yellow Cell Sponge	14cm	10cm	5cm	765139322620



CC926

Concrete Sliders



These knee skis are made of lightweight, tough heavy-duty Fibreglass, making them easy to use and clean. One size fits all. The knee skis allow you to get onto the concrete earlier as they create a larger surface area for your weight to be spread over.

Knee Boards				
Code	Description	Length	Weight	Barcode
CC153	Fibreglass Kneeboard	30" (762mm)	10kgs	765139611533



CC153

Air Hopper Gun



Double-handle design provides maximum support and control for ceiling, wall and floor applications. Sprays acoustics, drywall mud, waterproofing material, pool-deck sealant, stucco and most gravity-fed materials.

Air Hopper Gun		
Code	Description	Barcode
FR303A	Air Hopper Gun	9318428103038
FR-KIT	Repair Kit for FR303A	



FR303A

Gunite Shoes



Gunite shoes allow you to work on gunite, epoxy or sealers with ease of movement. They also protect and bring air bubbles out of the application. Available in three styles.

Gunite Shoes				
Code	Description	Spike Length	Size	Barcode
CC970	Aluminum Gunite Shoe	1" (25mm)	One Size Fits All	765139619706
HC177	Flexible Plastic Gunite Shoe	3/4" (19mm)	One Size Fits All	765139454109
HC178	Hard Plastic Gunite Shoe	1-1/2" (38mm)	One Size Fits All	765139335736



HC178

Handtools

Kneeling Boards

The kneeling boards are multipurpose boards and are designed to make kneeling easier. Perfect for concreters and flooring contractors, mechanics and gardeners alike.

EVA foam provides even more durability than EPE, with density and tear strength value standing at five times that of EPE. EPE has much greater recovery characteristics.

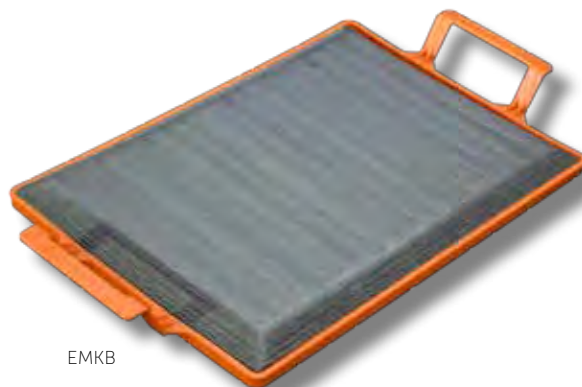

EMKB

Kneeling Boards			
Code	Description	Pack Qty	Barcode
EMKB	Easymix EPE Foam Kneeling Board	10	9318428101713
MFKB	Masterfinish EPE Foam Kneeling Board	10	9318428101713

Super-Soft Knee Pads



Offering the perfect combination of protection and comfort that other kneepads just can't match. They are so comfortable that they can be worn with shorts. The quick-fastening front-strap design and "clear zone" behind the knee eliminates rash or pinching that usually occurs from the inferior designs that use buckles, straps, or outdated fastening methods. They are constructed of 100% washable premium grade SBR neoprene.



17-209SOFTL

Knee Pads			
Code	Description	Pack Qty	Barcode
17-209SOFTL	Troxell Knee Pads	6	732826902373

Work Gloves



Masterfinish trade-tough contractors gloves are nitrile coated and perfect for landscaping, automotive work, concreting, carpentry, electrical work, gardening and manufacturing. Sold in packs of five.

Gloves				
Code	Description	Pack Qty	Min Order	Barcode
MFNGO-5	Masterfinish Work Gloves	5	48x5 Packs	9318428150001



Excel Tools - Sold In WA and SA Only

Excel Vee Jointer



SOLD IN WA AND SA ONLY - Used to form 'dummy' joints in concrete paving. The joint in the concrete reduces the thickness of the paving. If cracking occurs, the crack should be at the line of the 'dummy' joint. The joint should be 1/5 of the slab thickness. Blades are formed from stainless steel.

Excel Jointer						
Code	Description	Width	Length	Depth	Pack Qty	Barcode
C1	Vee Jointer	90mm	150mm	13mm	6	9318428102352
C1A	Long Walking Vee Jointer	90mm	300mm	12mm	6	9318428102369



C1



C1A

Excel Oblong Non-Skid Floor Float



SOLD IN WA AND SA ONLY - Used to 'rub up' a concrete floor prior to steel trowelling or to work in coloured dry shake. They produce a textured finish smoother than a wood float, which suits outdoor paving applications. The trowels feature a long-wearing robust steel blade that is turned up all round. Blades are formed from stainless steel.

Excel Non-Skid Float						
Code	Description	Width	Length	Pack Qty	Barcode	
C4	Oblong Non-Skid Floor Float	115mm	311mm	6	9318428102376	



C4

Excel Edgers



SOLD IN WA AND SA ONLY - Used to trowel a smooth finish to slab edges and produce a smooth face margin to textured wood float finished external paving. Blades are formed from stainless steel.

Excel Edgers							
Code	Description	Width	Length	Lip	Radius/Angle	Pack Qty	Barcode
C2	Edger	115mm	150mm	13mm	10mm	6	9318428102291
C5	Large Edger	155mm	205mm	14mm	11mm	6	9318428102307
C2E	Long Walking Edger	115mm	300mm	13mm	10mm	6	9318428102314
C2A	Special Edger	115mm	200mm	13mm	10mm	6	9318428102321
C2C	Bevel Edger	115mm	150mm	24mm	135°	6	9318428102338
C17	Bevel Edger	115mm	150mm	17mm	135°	6	9318428102345



C2E

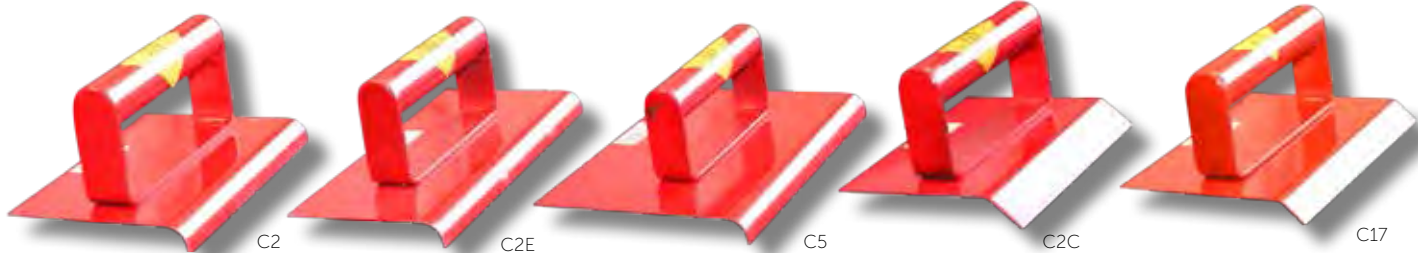

C2

C2E

C5

C2C

C17

For WA Barrows

For WA Mixers



See Pages 54



See Page 91



A.G. PULIE

Section 2 Sprayers



Sprayers

1949 - Industrial Viton® Concrete Open Head

3.5 gallon TriPoxy coated Sprayer with Viton™ Seals for the Concrete Professional (Chapin's Most Popular Industrial Sprayer).

- Viton™ seals
- TriPoxy steel tank with large Tri-Lock opening
- Brass spray handle, wand and nozzle
- Brass pump



FULLY
VITON®
EQUIPPED
SEALS & GASKETS

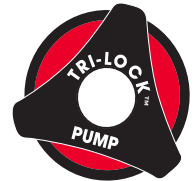

Metal Sprayers

Code	Description	Capacity	Barcode
1949	Ind Concrete Spray 13.2lts	3.5gal/13.2ltr	023883019495

Spare Parts

Code	Name	Description	Barcode
6-7703	Extension Wand	Brass 24" Curved Industrial Wand	023883677039
6-5373	Holster	Poly Wand Holster	023883653736
6-6091	Hose	48" Industrial Hose with Fitting	023883660918
1-5941	Nozzle	Brass 0.5GPM Fan Tip	N/A
1-5943	Nozzle	Brass 1.0GPM Fan Tip	N/A
3-7020-1	Pump Barrel	14" Brass Barrel Assembly	N/A
3-8986-1	Pump Rod	14" Pump Rod Assembly with Viton Seals	N/A
301065	Pump Assembly	Complete Pump Assembly	N/A
3-7720	Extension Wand	Brass 24" Straight Extension Wand	023883377205
6-6000	Nozzle	Brass Adjustable Cone Nozzle	023883660000
6-6062	Shut-off Assembly	Brass Industrial Shut-off	023883660628
3-5859-1	Outlet Tube	Outlet Tube	023883677459
6-4627	Repair Kit	Seal and Gasket Kit	023883646271
6-3337	Carry Strap	Carry Strap with Pad	023883633370



1979 - Industrial Viton® Concrete Open Head With Filter

1979 is a 13.2Ltr TriPoxy coated Sprayer with Viton™ Seals for the Concrete Professional.

- Viton® seals and gaskets
- TriPoxy steel tank with large Tri-Lock opening
- Brass spray handle, wand and nozzle
- Brass pump



FULLY
VITON®
SEALS &
GASKETS
EQUIPPED



Metal Sprayers			
Code	Description	Capacity	Barcode
1979	H/Duty Ind Concrete Spray 12.3	3.5gal/13.2ltr	023883019792

Spare Parts			
Code	Name	Description	Barcode
6-7703	Extension Wand	Brass 24" Curved Industrial Wand	023883677039
6-5373	Holster	Poly Wand Holster	023883653736
6-6092	Hose	48" Heavy Duty Industrial Hose with Fitting	023883660925
6-5797	Nozzle	Brass 0.5GPM Industrial Fan Tip with Adaptor	023883657970
1-5943	Nozzle	Brass 1.0GPM Fan Tip	N/A
3-7020-1	Pump Barrel	14" Brass Pump Barrel Assembly with Viton Seals	N/A
3-8986-1	Pump Rod	14" Pump Rod Assembly with Viton Seals	N/A
6-6062	Shut-off Assembly	Brass Industrial Shut-off with Fittings	023883660628
6-7745	Outlet Tube	Outlet Tube with Filter Accessory	023883677459
6-4627	Repair Kit	Seal and Gasket Kit	023883646271
6-3337	Carry Strap	Carry Strap with Pad	023883633370
301065	Pump Assembly	Complete Pump Assembly	N/A
3-7720	Extension Wand	Brass 24" Straight Extension Wand	023883377205
6-6000	Nozzle	Brass Adjustable Cone Nozzle	023883660000

19149 - Industrial Concrete Sprayer With Dripless Shut-Off

3.5 gallon TriPoxy coated Sprayer with Viton™ Seals for the Concrete Professional (Chapin's Most Popular Industrial Sprayer).

- Viton™ seals
- TriPoxy steel tank with large Tri-Lock opening
- Brass spray handle, wand and nozzle
- Brass pump



FULLY
VITON®
SEALS &
GASKETS
EQUIPPED



Metal Sprayers			
Code	Description	Capacity	Barcode
19149	13.25L Dripless Spray	3.5gal/13.2ltr	023883191498

Spare Parts			
Code	Name	Description	Barcode
6-8135	Dripless Shut-off	Dripless Shut-off Handle	023883681357
6-5373	Holster	Poly Holster	023883653736
6-6091	Hose	48" Hose with Fittings	023883660918
6-5797	Nozzle	Brass .5GPM Industrial Fan Tip with Adapter	023883657970
1-5943	Nozzle	Brass 1.0GPM Fan Tip	N/A
3-5859-1	Outlet Tube	Outlet Tube with Viton O-Ring	N/A
301065	Pump Assembly	Complete Pump Assembly	N/A
6-7745	Outlet Tube	Outlet Tube with Filter	023883677459
6-8136	Dripless Xtreme	Dripless Xtreme Seal Kit	023883681364
6-4627	Repair Kit	Seal and Gasket Kit	023883646271
6-3337	Carry Strap	Carry Strap with Pad	023883633370
3-7720	Extension Wand	Brass 24" Straight Extension Wand	023883377205

Sprayers

19049 Sprayer - Xtreme™ Industrial Concrete Sprayer



19049 is a 13.2 Ltr TriPoxy coated Sprayer with Xtreme™ Seals for the Concrete Professional. This sprayer uses upgraded seals, shut off and hose to handle more high level aggressive curing compounds and sealers.

- Xtreme™ Viton® seals and gaskets
- TriPoxy steel tank with large Tri-Lock opening
- Brass spray handle, wand and nozzle
- Brass pump

Metal Sprayers			
Code	Description	Capacity	Barcode
19049	Extreme Chapin Spray	3.5gal/13.2ltr	023883190491

Spare Parts			
Code	Name	Description	Barcode
6-7705	Extension Wand	Xtreme Extension Wand with Viton seal	023883677053
6-5373	Holster	Poly Wand Holster	023883653736
6-5797	Nozzle	Brass 0.5GPM Industrial Fan Tip Nozzle with adapter	023883657970
6-6092	Hose	48" Industrial Hose Heavy Duty	023883660925
6-4646	Repair Kit	KIT OH Extreme with Blister	023883646462
301191	Complete Pump	Complete Pump Assembly	N/A
3-5859-1	Outlet Tube	Outlet Tube Assembly with VITON O-Ring	N/A
1-5943	Nozzle	Brass 1.0GPM Fan Tip Female	N/A
6-3337	Carry Strap	Carry Strap with Pad	023883633370
6-5380	Shut-off Assembly	Brass Shut-Off Assembly for Xtreme Sprayers	023883653804
3-7720	Extension Wand	Brass 24" Straight Extension Wand	023883377205



19069 - Stainless Steel Xtreme™ Industrial Concrete Sprayer



3.5 gallon Stainless Steel Sprayer with Xtreme™ Seals for the Concrete Professional.

- Xtreme™ viton® seals and gaskets
- TriPoxy Steel Tank with large Tri-Lock opening
- Brass spray handle, wand and nozzle
- Brass pump

Metal Sprayers			
Code	Description	Capacity	Barcode
19069	Extreme SS Chapin Spray	3.5gal/13.2ltr	023883190699

Spare Parts			
Code	Name	Description	Barcode
6-7705	Extension Wand	Xtreme Extension Wand with Viton seal	023883677053
6-5373	Holster	Poly Wand Holster	023883653736
6-6092	Hose	48" Industrial Hose Heavy Duty	023883660925
6-4646	Repair Kit	KIT OH Extreme with Blister	023883646462
301191	Complete Pump	Complete Pump Assembly	N/A
3-5859-1	Outlet Tube	Outlet Tube Assembly with VITON O-Ring	N/A
1-5943	Nozzle	Brass 1.0GPM Fan Tip Female	N/A
6-3337	Carry Strap	Carry Strap with Pad	023883633370
6-5380	Shut-off Assembly	Brass Shut-Off Assembly for Xtreme Sprayers	023883653804
3-7720	Extension Wand	Brass 24" Straight Extension Wand	023883377205



1999 - Industrial Viton® Concrete Comp Charged

Industrial Viton Sprayer, 3.5 gallon hammertone and TriPoxy coated sprayer with Viton seals and Schreader Valve for compressor hookup for the Concrete Professional.

- Viton® seals and gaskets
- Schreader valve for compressor hook up
- Brass spray handle, wand and Nozzle
- Brass pump



FULLY
VITON®
EQUIPPED



Metal Sprayers			
Code	Description	Capacity	Barcode
1999	H/Duty Ind Spray Air Con 13.2L	3.5gal/13.2ltr	023883019990

Spare Parts			
Code	Name	Description	Barcode
1-2619-1	Extension Clip	Poly Clip to Hold Sprayer Extension	N/A
6-7711	Extension Wand	Brass 18" Extension Wand	023883677114
6-7704	Extension Wand	Brass 24" Extension Wand	023883677046
6-5373	Holster	Poly Wand Holster	023883653736
301014-1	Handle	Replacement Cast Ergo Handle	N/A
6-6092	Hose	48" Heavy Duty Industrial Hose	023883660925
6-6091	Hose	48" Industrial Hose with Fittings	023883660918
1-4182	Retainer Ring	Replacement Retainer Ring	N/A
1-5915	Nozzle	Brass 0.5GPM Fan Tip Nozzle	N/A
6-5797	Nozzle	Brass 0.5GPM Industrial Fan Tip with Adapter	N/A
6-7745	Outlet Tube	Outlet Tube with Filter Accessory	023883677459
3-5859-1	Outlet Tube	Outlet Tube with Viton O-Ring	N/A
301065	Pump Assembly	Complete Pump Assembly	N/A
6-4627	Repair Kit	Seal and Gasket Kit	023883646271
6-4629	Repair Kit	Seal and Gasket Kit with Viton	023883646295
6-6062	Shut-Off	Brass Shut-Off Assembly with Fittings	023883660628
6-3337	Carry Strap	Carry Strap with Pad	023883633370
3-7720	Extension Wand	Brass 24" Straight Extension Wand	023883377205

22240XP - Industrial Acid Staining Sprayer - XP Model

7.6Ltr gallon Acid Staining sprayer with COPT seals for the Decorative Concrete Professional. Now with 40% more pump volume per stroke.

- COPT seals and gaskets to handle acid Based Concrete Stains
- Translucent 7.6ltr poly tank
- Pressure relief valve
- Funnel top for easy filling



Plastic Sprayers			
Code	Description	Capacity	Barcode
22240XP	Spray (2.0G/7.6ltr)	2.0gal/7.6ltr	023883222406

Spare Parts			
Code	Name	Description	Barcode
6-5353	Spray Shield	Spray Shield for Acid Sprayer	023883653538
6-5370	Extension Wand	Poly 12" Extension wand	023883653705
2-5582-6	Replacement Handle	Replacement D-Handle	N/A
6-6136	Hose	42" Replacement Hose	023883661366
6-5372	Nozzle	Poly Adjustable Nozzle	023883653729
301289	Pump Barrel	Pump Barrel Assembly	N/A
2-8516	Replacement Rod	Steel Pump Rod	N/A
6-5384	Repair Kit	Replacement Valve and Seal Kit	023883653842
6-5369	Relief Valve Kit	Relief Valve Kit for Poly Open Head Sprayer	N/A
6-5371	Shut-off Assembly	Poly Shut-off Assembly	023883653712
1-2931	Spring	Replacement Shut-off Spring	N/A
6-3337	Carry Strap	Carry Strap With Pad	023883633370

Sprayers

4163 - Industrial Water Supply Tank

13.2Ltr Chapin TriPoxy coated water supply tank.

- 13.2Ltr TriPoxy coated Sprayer and pump
- Metal water supply tank
- Ergo "comfort" handle
- Water tank used for cutting tools; hose adapter



Metal Sprayers			
Code	Description	Capacity	Barcode
4163	Industrial Water Supply Tank	3.5gal/13.2ltr	023883041632

Spare Parts			
Code	Name	Description	Barcode
3-7020-1	Pump Barrel Assembly	14/35 6cm Brass Pump Assembly	N/A
3-5859-1	Outlet Tube	Outlet Tube Assembly with Viton O-Ring	N/A

22790XP - Industrial Poly Viton® Heavy Duty - XP Model

3.0 gallon industrial poly sprayer for multi-purpose use. Now with 40% more pump volume per stroke.

- Viton® seals and gaskets
- Brass shut-off with lock-on feature
- Pressure relief valve
- Surespray® anti-clog Filter



Plastic Sprayers			
Code	Description	Capacity	Barcode
22790XP	11.4 Ind OH PLB Viton	3.0gal/11.4ltr	023883653736

Spare Parts			
Code	Name	Description	Barcode
6-7742	Extension Wand	Brass 18" Extension Wand	023883677428
6-7704	Extension Wand	Brass 24" Extension Wand	023883677046
1-5941	Nozzle	Brass 0.5GPM Fan Tip Nozzle	N/A
6-5797	Nozzle	Brass 0.5GPM Industrial Fan Tip	N/A
301241-1	Pump Assembly	Replacement Pump Assembly	N/A
6-5384	Repair Kit	Replacement Parts Kit	023883653842
010022-1	Plunger O-Ring	Replacement Plunger O-Ring	N/A
010023	Barrel O-Ring	Replacement Barrel O-Ring	N/A
1-4324-1	Bottom Valve	Replacement Bottom Valve	N/A
010546	Tank O-Ring	Replacement Tank Cap O-Ring	N/A
6-1898	Shut-Off	Brass Industrial Shut-off Assembly	023883618988
1-2931	Spring	Replacement Shut-Off Spring	N/A
6-3337	Carry Strap	Carry Strap with Pad	023883633370
2-5582-6	Handle	Replacement Handle	N/A
6-6141	Hose	Nylon Reinforced Hose with Clamps	023883661410
3-7720	Extension Wand	Brass 24" Straight Extension Wand	023883377205

63900 -Commercial Duty Jet Clean Dual Displacement Backpack Sprayer



4 gallon Commercial duty jet clean dual displacement pump backpack sprayer.

- Diaphragm pump for wettable powders
- 3 stage filtration system
- 4" wide opening with strainer/filter basket
- Padded Shoulder Straps
- 3 pc nozzle pack (fan, cone and adjustable brass nozzles)
- Extra wide mouth

Plastic Sprayers			
Code	Description	Capacity	Barcode
63900	Commercial Duty Backpack Sprayer	4.0gal/15.1ltr	023883639006
Spare Parts			
Code	Name	Description	Barcode
6-8096	Nozzle	Brass Flat Fan Nozzle	023883680961
6-8122	Nozzle	Brass Adjustable Nozzle	023883681227
6-8093	Nozzle	Poly Adjustable Nozzle	023883680930
6-8148	Nozzle Kit	Poly Elbow Nozzle	023883681487
6-8169	Filter	Filter Replacement Kit	023883681692
6-8149	Extension Wand	Extension Wand Assembly	023883681494
6-8105	Hose	Hose Assembly	023883681494
6-8120B	Repair Kit	Shut-off Valve Repair Kit	023883999995
6-8138	Shut-off	Shut-off Assembly	023883681388
6-8224	Piston	Piston/ Diaphragm Pump	N/A
6-8225	Collar	Piston Collar	N/A
6-8153	Repair Kit	O-Ring Kit	023883681531
6-8146-1	Filter	Filter Basket and Cap	023883681463
6-8182	Strap	Backpad and Strap	023883681821
6-8150	Clip	Wand Clip	023883681500



64800 - Poly Backpack Sprayer



A 4 gallon backpack diaphragm sprayer with standard features for the landscape and turf professional.

- Diaphragm pump for wettable powders
- 3 stage filtration system
- 4" wide opening with strainer/filter basket
- Padded shoulder straps
- 3 pc nozzle pack (fan, cone and adjustable brass nozzles)

Plastic Sprayers			
Code	Description	Capacity	Barcode
64800	Poly Backpack Diaphragm Sprayer	4.0gal/15.1ltr	023883648008
Spare Parts			
Code	Name	Description	Barcode
6-8151	Pressure Regulator	Replacement Pressure Regulator	023883681517
302001	Pump Handle	Replacement Pump Handle	N/A
6-8146	Filter Basket	Replacement Filter Basket with Cap	023883681463
6-8167	Repair Kit	Replacement Pump Seal Kit	023883681678
6-8183	Diaphragm Assembly	Diaphragm Assembly with Lever	023883681838
011236	Strap Clip	Backpack Strap Clip	N/A
6-8137	Strap	Replacement Strap	023883681371



Sprayers

61800 - ProSeries Backpack Sprayer

4 gallon backpack sprayer with deluxe features for the landscape & turf professional.



- 3 stage filtration system
- 4" Wide opening with strainer/filter basket
- Padded shoulder straps
- 3 pc nozzle pack (fan, cone and adjustable brass nozzles)

Plastic Sprayers			
Code	Description	Capacity	Barcode
61800	ProSeries B/Pack 15.1Ltrs	4.0gal/15.1ltr	023883618001
Spare Parts			
Code	Name	Description	Barcode
6-8219	Extension Wand	20" Poly Straight Extension Wand	023883682194
6-8105	Hose	48" Transparent reinforced Hose	023883681050
6-8131	Nozzle	Complete Nozzle Assembly	023883681319
6-8138	Shut-off	Poly Shut-off Assembly	023883681388
6-8137	Strap	Replacement Strap	023883681371
6-8178	Piston	Piston Cylinder Assembly	023883681784
6-8180	Piston Repair Kit	Piston Pump Repair Kit	023883681807
6-8179	Pump Piston	Pump Piston Assembly	023883681791
6-8151	Pressure Regulator	Replacement Pressure Regulator	023883681517
302001	Pump Handle	Backpack Pump Handle	N/A
6-8168	Lever Kit	Piston Lever Kit	023883681685
6-8146	Filter Basket	Replacement Filter Basket with Cap	023883681463
6-8134	Pump Piston	Replacement Pump Piston Collar	023883681340



EMS15 Sprayer



Easymix backpack sprayer. Large pump for pressurising quickly with less pumping. Internal four position pressure spray valve. Padded carry straps. Pump handle adjustable for right or left handed use.

Plastic Sprayers			
Code	Description	Capacity	Barcode
EMS15	Easymix Backpack Sprayer	4.0gal/15.1ltr	9318428100365
Spare Parts			
Code	Name	Description	Barcode
EMS15RW	Wand	Replacement Wand	N/A
EMS15RH	Hose	Replacement Hose 48"	N/A
EMS15RN	Nozzle	Nozzle Complete Assembly	N/A
EMS15RV	Sprayer Handle	Shut-off Valve Assembly	N/A
EMS15RK	Repair Kit	Seal Replacement Kit	N/A



26021XP - Poly Pro Series Sprayer - XP Model

2 gallon Pro Series poly sprayer for the lawn & landscaping professional. Now with 40% more pump volume per stroke.

- 4" large opening for easy filling
- Includes comfort grip handle, poly fan nozzle, poly and brass adjustable nozzles
- Includes SureSpray® Anti-Clog Filter
- 20" poly wand and 34" reinforced hose with cushion grip shut-off and internal filter



Plastic Sprayers			
Code	Description	Capacity	Barcode
26021XP	ProSeries Poly Sprayer	2.0gal/7.6ltr	023883260217

Spare Parts			
Code	Name	Description	Barcode
6-8131	Nozzle	Repl. Nozzle	023883681319
6-8138	Sprayer Handle	Repl. shut-off assembly	023883681388
6-8130	Hose	Repl. Hose	023883681302
6-8153	Repair Kit	Repl. Discharge Repair Kit	023883681531
301525-1	Complete Pump	Pump. Assy. Pro OH VITON Valve Cap	N/A
6-8219	Extension Wand	20" Poly Straight Extension Wand	023883682194
6-8122	Nozzle	Brass Adjustable Nozzle	023883681227
6-8096	Nozzle	Poly Flat Fan Nozzle	023883680961



26031XP - Poly Pro Series Sprayer - XP Model

3 gallon Pro Series poly sprayer for the lawn & landscaping professional. Now with 40% more pump volume per stroke.

- Viton® seals and gaskets
- Cushion grip shut-off with internal filter
- SureSpray® anti-clog Filter
- Pressure relief valve



Plastic Sprayers			
Code	Description	Capacity	Barcode
26031XP	ProSeries Poly Sprayer	3.0gal/11.4ltr	023883260316

Spare Parts			
Code	Name	Description	Barcode
6-8131	Nozzle	Repl. Nozzle	023883681319
6-8138	Sprayer Handle	Repl. shut-off assembly	023883681388
6-8130	Hose	Repl. Hose	023883681302
6-8153	Repair Kit	Repl. Discharge Repair Kit	023883681531
301525-1	Complete Pump	Pump. Assy. Pro OH VITON Valve Cap	N/A
6-8219	Extension Wand	20" Poly Straight Extension Wand	023883682194
6-8122	Nozzle	Brass Adjustable Nozzle	023883681227
6-8096	Nozzle	Poly Flat Fan Nozzle	023883680961



Sprayers

1046 - Industrial Viton® Cleaner/Degreaser



48oz. Multi-Purpose Hand Sprayer for cleaning/degreasing. Translucent bottle for checking fluid level. Hand held operation.

- Viton™ seals
- Adjustable cone nozzle
- 48oz recleanable bottle
- SureSpray™ anti-clog Filter

Plastic Sprayers			
Code	Description	Capacity	Barcode
1046	Multi-Purpose Hand Sprayer	48oz/1.4ltr	023883010461
Spare Parts			
Code	Name	Description	Barcode
3-1853	Repair Kit	Valve Kit	023883185305
3-1802	Nozzle	Poly Adjustable Cone Nozzle	N/A
1-3576	Replacement Pin	Replacement Shut-off Pin	N/A
3-1853-1	Viton Kit	Replacement Viton Value Kit	N/A



1003 - Farm & Field Hand Sprayer



48oz. Farm & Field Hand Sprayer.

- Nitrile seals for handling most cleaning solutions, herbicides, and pesticides
- Adjustable cone nozzle
- Translucent tank
- SureSpray™ anti-clog Filter

Plastic Sprayers			
Code	Description	Capacity	Barcode
1003	F & F Hand Held Sprayer	48oz/1.4ltr	023883010034
Spare Parts			
Code	Name	Description	Barcode
3-1802	Nozzle	Poly Adjustable Cone Pattern Nozzle	N/A
3-1853	Repair Kit	Valve Kit	023883185305
1-3576	Pin Clip	Replacement Pin Clip	N/A



FM5000 Foam Sprayer



The Foam-Matic 5 P is a mobile foamer which works fast with excellent foam quality and high performance. It's made with an impact resistant Polyethylene tank with 5 litre filling, 2.5 litres air compression volume and 4 bar operating pressure.

Plastic Sprayers			
Code	Description	Capacity	Barcode
FM5000	Birchmeier Foam-Matic Foamer	5ltr	7611034121338

Spare Parts			
Code	Name	Description	Barcode
11617902-SB	Safety Valve	Safety valve 4 bar PP Viton	7911034710181
50137532	Valve	Replacement Valve	7611034040653
11625301-SB	Pump	Pump Black 1.4301 PP Viton red	7611034710150
10853203-SB	Guidage	Guidage with sleeve; 6 per pack	7611034040066
11642701-SB	Sleeve	Sleeve; 6 per pack	7611034040059
11910101	Air Valve	Air Valve Assembly	7611034113173
11908201	Hose	Hose Assembly 1.5m G1/2"-G1/2"-ø10	7611034110479
11907101	Trigger Kit	Trigger Kit Assembly	7611034040639
11927401	Foam Tube	Foam Tube Assembly	7911034113746
10453601	Belt	Carrying Belt	7611034100739
11887301	Handle	Two Hand Grip	7611034040578
11905101-SB	Gasket Set	Replacement Gasket Set	7911034040660



FM125 Foam Sprayer



The Foam-Matic 1.25 P is a top quality hand compression foamer for professional and mobile foaming. It produces a very special and dry foam which gives it a long contact time. It's made with a 1.25 litre impact resistant polyethylene tank, transparent with a litre scale. It has a powerful hand pump with an ergonomic handle and spray button.

Plastic Sprayers			
Code	Description	Capacity	Barcode
FM125	Birchmeier Foam-Matic Foamer	1.25ltr	7611034121338

Spare Parts			
Code	Name	Description	Barcode
11926201	Foam Tube	Foam Tube Assembly	7610034113708
11614802	Gasket Set	Replacement Gasket Set	7611034700427



For Concrete Removers See Page 105



PROUDLY AUSTRALIAN
ESTABLISHED
1951
PROUDLY AUSTRALIAN

A.G. PULIE

Section 3 Material Handling



DIY Steel Wheelbarrow



Wheelbarrows			
Code	Description	Weight	Capacity
W60S	Entry Level Steel Wheelbarrow	7.8kg	60ltr

- 60ltr 0.6mm powder-coated steel tray
- Powder-coated steel handles with a diameter of 25mm
- 25mm tubular welded legs
- 13" Pneumatic 4-ply tyre
- Poly rim and tubular 15.9mm axle
- Subject to availability



Comes in a variety of colours

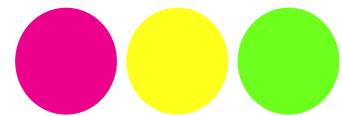

*orders will be supplied in a random selection of colours

DIY Poly Wheelbarrow



Wheelbarrows			
Code	Description	Weight	Capacity
W70P	Entry Level Poly Wheelbarrow	8.3kg	67ltr

- 67ltr 3mm poly tray
- Powder-coated steel handles with a diameter of 25mm
- Tubular welded legs
- 16" Pneumatic 4-ply tyre
- Poly rim and solid 19.5mm axle
- Subject to availability



Comes in a variety of colours



*orders will be supplied in a random selection of colours

Blue Steel Handyman Wheelbarrow



Wheelbarrows			
Code	Description	Weight	Capacity
W250S	Handyman 100 LT Stl Tray Barrow	16kgs	100ltr

- 100ltr capacity steel tray
- Zinc-coated steel handles 25x50mm
- Powder-coated 30mm flat bar undercarriage
- 25mm upright supports
- 16" x 4-8 pneumatic 4 ply tyre
- Steel rim and 25mm axle



Poly Handyman Wheelbarrow



Wheelbarrows			
Code	Description	Weight	Capacity
W250P	Handyman 100 LT Poly Tray Barrow	13kgs	100ltr

- 100ltr capacity poly tray
- Zinc-coated steel handles 25x50mm
- Powder-coated 30mm flat bar undercarriage
- 25mm upright supports
- 16" x 4-8 pneumatic 4 ply tyre
- Steel rim and 25mm axle



Material Handling

Red Steel Contractors Wheelbarrow



Wheelbarrows			
Code	Description	Weight	Capacity
W300S-HSRWRS	Red W/Barrow with Steel Tray	23kg	100ltr

- 100ltr capacity red steel tray
- Seamless 0.8mm powder-coated tray
- Powder-coated steel handles 25x50mm
- Powder-coated 32mm K-frame undercarriage
- 32mm upright supports
- 16"x6.50-8 pneumatic 4 ply tyre
- Steel rim and 25mm axle
- 32mm cross tray support bars



W300S-HSRNGS
Narrow Pneumatic
Wheel



W300S-HSRNBS
Narrow FLAT FREE
Wheel

Red Poly Contractors Wheelbarrow



Wheelbarrows			
Code	Description	Weight	Capacity
W300P-HSRWRS	Red W/Barrow with Poly Tray	20kg	100ltr

- 100ltr poly tray
- Powder-coated steel handles 25x50mm
- Powder-coated 32mm K-frame undercarriage
- 32mm upright supports
- 16" x 6.50-8 pneumatic 4 ply tyre
- Steel rim and 25mm axle
- 32mm cross tray support bars



W300P-HSRNGS
Narrow Pneumatic
Wheel



W300P-HSRNBS
Narrow FLAT FREE
Wheel

Green Steel Heavy Duty Landscapers Wheelbarrow



Wheelbarrows			
Code	Description	Weight	Capacity
W700S-HTHWAS	Green Steel Landscapers Wheelbarrow	28kgs	100ltr

- Heavy-duty 100ltr 1.2mm steel tray
- 7mm poly impact board
- Timber handle 32 x 55 x 1500mm
- Contoured handle grips
- Heavy-duty 32mm flat bar welded legs
- 16 x 6.50 x 8 Pneumatic tyre
- Solid 25mm axle and steel rim
- Heavy-duty 32 x 6mm flat bar undercarriage



W700S-HTHNGS
Narrow Pneumatic
Wheel



W700S-HTHNBS
Narrow FLAT FREE
wheel



W700S-HTHWGP
Wide FLAT FREE
wheel

Green Poly Heavy Duty Landscapers Wheelbarrow



Wheelbarrows			
Code	Description	Weight	Capacity
W700P-HTHWAS	Green Poly Landscapers Wheelbarrow	24kgs	100ltr

- Heavy-duty 100ltr 1.2mm poly tray
- 7mm poly impact board
- Timber handle 32 x 55 x 1500mm
- Contoured handle grips
- Heavy duty 32mm flat bar welded legs
- 16 x 6.5 x 8 Pneumatic tyre
- Solid 25mm axle and steel rim
- Heavy-duty 32 x 6mm flat bar undercarriage



W700P-HTHNGS
Narrow Pneumatic
Wheel



W700P-HTHNBS
Narrow FLAT FREE
wheel



W700P-HTHWGP
Wide FLAT FREE
wheel

Material Handling

Green Steel Heavy Duty Contractors Wheelbarrow



Green Steel Wheelbarrows			
Code	Description	Weight	Capacity
W800S-HSGWAS	Green Steel Contractors Wheelbarrow	25kg	100ltr

- High capacity seamless 100ltr 1.2mm steel tray
- 7mm poly impact board
- Powder-coated steel handles 57 x 35mm
- Contoured handle grips
- Heavy-duty 32mm tubular welded legs
- 16 x 6.5 x 8 pneumatic tyre
- Solid 25mm axle and steel rim



W800S-HSGNGS
Narrow Pneumatic wheel with green Steel handles



W800S-HSGNBS
Narrow FLAT FREE wheel with green Steel handles



W800S-HSGWGP
Wide FLAT FREE wheel with green Steel handles



W800S-HTHWAS
Wide Pneumatic wheel with Timber handles



W800S-HTHNBS
Narrow Pneumatic wheel with Timber handles



W800S-HTHNBS
Narrow FLAT FREE wheel with Timber handles



W800S-HTHWGP
Wide FLAT FREE wheel with Timber handles

Green Poly Heavy Duty Contractors Wheelbarrow



Wheelbarrows			
Code	Description	Weight	Capacity
W800P-HSGWAS	Green Poly Contractors Wheelbarrow	21kg	100ltr

- High capacity 100ltr Poly Tray
- 7mm poly impact board
- Powder-coated steel handles 57 x 35mm
- Contoured handle grips
- Heavy-duty 32mm tubular welded legs
- 16 x 6.5 x 8 pneumatic tyre
- 25mm axle and steel rim



W800P-HSGNGS
Narrow Pneumatic wheel with green Steel handles



W800P-HSGNBS
Narrow FLAT FREE wheel with green Steel handles



W800P-HSGWGP
Wide FLAT FREE wheel with green Steel handles



W800P-HTHWAS
Wide Pneumatic wheel with Timber handles



W800P-HTHNBS
Narrow Pneumatic wheel with Timber handles



W800P-HTHNBS
Narrow FLAT FREE wheel with Timber handles



W800P-HTHWGP
Wide FLAT FREE wheel with Timber handles

Blue Steel Extra Heavy-Duty Contractors Wheelbarrow



Wheelbarrows			
Code	Description	Weight	Capacity
W900S-HSBWGP	Blue Steel W/Barrow HD Steel Tray	28.5kg	100ltr

- High capacity seamless 100ltr 1.2mm tray
- 7mm Poly impact board
- Powder-coated steel handles 57 x 35mm
- Contoured handle grips
- Heavy-duty 32mm tubular welded legs
- 25mm cross tray support
- 16 x 6.5 x 8 flat free tyre
- Heavy-duty steel rim and solid 25mm axle



W900S-HSBNGS
Narrow Pneumatic wheel with blue Steel handles



W900S-HSBNBS
Narrow FLAT FREE wheel with blue Steel handles



W900S-HSBWAS
Wide FLAT FREE wheel with blue Steel handles



W900S-HTHWAS
Wide Pneumatic wheel with Timber handles



W900S-HTHNGS
Narrow Pneumatic wheel with Timber handles



W900S-HTHNBS
Narrow FLAT FREE wheel with Timber handles



W900S-HTHWGP
Wide FLAT FREE wheel with Timber handles

Heavy-Duty Contractors Wheelbarrow with Pouring Lip



Wheelbarrows			
Code	Description	Weight	Capacity
W900P-HSBWGP	Blue W/Barrow HD Poly Tray	20kg	100ltr

- High capacity Poly 100ltr 5mm tray
- Built-in pouring lip
- Powder-coated steel handles 57 x 35mm
- Contoured handle grips
- Heavy-duty 32mm tubular welded legs
- 25mm cross tray support
- 16 x 6.5 x 8 flat free tyre
- Heavy-duty steel rim and solid 25mm axle



W900P-HSBNGS
Narrow Pneumatic wheel with blue Steel handles



W900P-HSBNBS
Narrow FLAT FREE wheel with blue Steel handles



W900P-HSBWAS
Wide FLAT FREE wheel with blue Steel handles



W900P-HTHWAS
Wide Pneumatic wheel with Timber handles



W900P-HTHNGS
Narrow Pneumatic wheel with Timber handles



W900P-HTHNBS
Narrow FLAT FREE wheel with Timber handles



W900P-HTHWGP
Wide FLAT FREE wheel with Timber handles

Material Handling

Boss Extra Heavy-Duty Contractors Wheelbarrow



Wheelbarrows			
Code	Description	Weight	Capacity
W1000-HBHNGS	Boss Timber Handle Pneumatic Barrow	32kg	100ltr

- 100ltr 1.2mm folded heavy-duty tray
- Timber handles 32 x 55 x 1500mm
- 1.2mm steel impact board
- Heavy-duty 32 x 6mm flat bar undercarriage
- 32mm pipe under tray supports
- 16 x 4.00-8 pneumatic 6 ply tyre
- Heavy-duty steel rim and 25mm solid axle



For Trestles



See Page 20



W1000-HBHNGS
Narrow FLAT FREE
wheel

Boss Extra Heavy Duty Square Tray Contractors Wheelbarrow



Wheelbarrows			
Code	Description	Weight	Capacity
FU1200-HBHNGS	Boss Timber Handle Pneumatic Square Barrow	32kg	100ltr

- 100ltr 1.2mm folded heavy-duty Square tray
- Timber handles 32 x 55 x 1500mm
- 1.2mm steel impact board
- Heavy-duty 32 x 6mm flat bar undercarriage
- 32mm pipe under tray supports
- 16 x 4.00-8 pneumatic 6 ply tyre
- Heavy-duty steel rim and 25mm solid axle



FU1200-HBHNGS
Narrow FLAT FREE
wheel

Red Steel WA and SA Heavy-Duty Contractors Wheelbarrow



Wheelbarrows			
Code	Description	Weight	Capacity
566W-S	Heavy-Duty Red Steel Tray W/barrow	23kg	99ltr

- High capacity 99ltr 1.0mm powder-coated steel tray
- Powder-coated steel handles 25 x 50mm
- Contoured handle grips
- Heavy-duty 32mm tubular welded legs
- 16 x 6.5 - 8 Pneumatic 4 ply tyre
- Heavy duty steel rim and solid 25mm axle
- Fitted with a large lifting hook
- Available in Western Australia and South Australia only



566W-S-FF
Wide Flat Free Wheel

Red Poly WA and SA Heavy-Duty Contractors Wheelbarrow



Wheelbarrows			
Code	Description	Weight	Capacity
566W-P	Heavy-Duty Red Poly Tray W/barrow	20kg	99ltr

- High capacity 99ltr 1.0mm poly tray
- Powder-coated steel handles 25 x 50mm
- Contoured handle grips
- Heavy-duty 32mm tubular welded legs
- 16 x 6.5 - 8 Pneumatic 4-ply tyre
- Heavy-duty steel rim and solid 25mm axle
- Fitted with a large lifting hook
- Available in Western Australia and South Australia only



566W-P-FF
Wide Flat Free Wheel

Material Handling

Heavy-Duty Contractors Wheelbarrow with Pouring Lip



Wheelbarrows			
Code	Description	Weight	Capacity
W500P	Heavy Duty Narrow Pouring W/Barrow	18kg	65ltr

- High capacity 65ltr poly tray
- Built-in pouring lip
- Narrow design, 560mm wide
- Perfect for doorways
- Powder-coated steel handles 32mm
- Contoured handle grips
- Heavy duty 32mm tubular welded legs
- 16 x 4.00 - 8 pneumatic 6 ply tyre
- Heavy-duty steel rim and solid 25mm axle



W500P-FF
Flat Free Wheel

WA Heavy Duty Contractors Poly Narrow Wheelbarrow



Wheelbarrows			
Code	Description	Weight	Capacity
W400-S	Heavy-Duty Poly Narrow W/Barrow	20kg	99ltr

- High capacity 99ltr poly tray
- 7mm poly impact board
- Powder-coated steel handles 25 x 50mm
- Contoured handle grips
- Heavy-duty 32mm tubular welded legs
- 16 x 6.5 - 8 pneumatic tyre
- Heavy-duty steel rim and solid 25mm axle
- Available in Western Australia only



W400-FF-SH
Flat Free Wheel

Boss Brickies Flat Tray Wheelbarrow



Wheelbarrows		
Code	Description	Weight
W1100-HBHNGS	Boss Brickies Flat Tray Timber Handle	27kg

- 1.2mm galvanised folded steel
- Timber handles 32 x 55 x 1500mm
- 1.2mm galvanised impact board
- Heavy-duty 32 x 6mm flat bar undercarriage
- 32mm pipe under tray supports
- 16 x 4.00-8 pneumatic 6-ply tyre
- Heavy-duty steel rim and solid 25mm axle



W1100-HBHNBS
Narrow FLAT FREE
wheel

Maximus Extra Heavy Duty Contractors Wheelbarrow



Wheelbarrows			
Code	Description	Weight	Capacity
W12-650	SA Heavy Duty Steel Wheelbarrow	30	100ltr

- High capacity 100ltr 1.1mm extra heavy-duty powder-coated steel tray
- Powder-coated 2.6mm steel pipe handles
- Heavy-duty rubber handle grips
- Heavy-duty 6mm flat bar welded legs
- 16 x 6.5 - 8 Pneumatic 4-ply tyre
- Heavy-duty steel rim and solid 25mm axle
- Available in South Australia only



W12-400
Narrow FLAT FREE
wheel

Material Handling

Brick Trolleys



Brick Trolleys		
Code	Description	Barcode
BT-1	Brick Trolley Straight Handles	9318428101430
BT-2	Brick Trolley Curled Handles	9318428101447

- Heavy gauge pipe frame
- 16.650x8 heavy duty steel rim
- 4-ply tyres



P-Handle Trolleys



Trolleys				
Code	Description	Weight Capacity	Wheel Type	Barcode
PT700	Easymix P-Handle Trolley	200kg	Pneumatic Tyres	9318428100259
PT700FF	Easymix P Handle Trolley	200kg	Flat Free	9318428107005

- 350 x 215 x 3mm shoe
- Dimensions: 1320 (h) x 555mm (w)
- Construction for light use and fully powder-coated
- Fully-welded frame gives maximum strength and longevity
- Ergonomically designed "P" handle to help better control for single-handed use
- For the PT700, 4.10 x 3.50 x 4" steel rimmed pneumatic wheels; 2-ply
- For the PT700FF, 250 x 70mm x 4" steel rimmed FLAT FREE wheels; 2-ply
- Replacement wheel: PT-PN - pneumatic
PT-FF - FLAT FREE



200KG

Light Duty General Purpose Trolley



Trolleys				
Code	Description	Weight Capacity	Wheel Type	Barcode
HT700LD	Easymix Light Duty Hand Trolley	100kg	Solid	9318428100242

- 375 x 330 x 3mm shoe
- Dimensions: 1060mm (h) x 480mm (w)
- Robust construction for extra strength and fully powder-coated
- Fully-welded steel frame gives maximum strength and longevity
- 8" solid wheels prevent punctures for increased productivity
- Replacement wheel: HT-LD

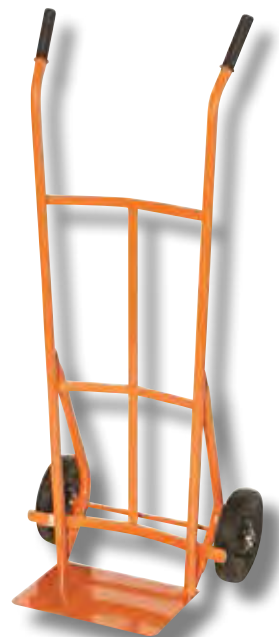

100KG

Wheel Type
Solid

General Purpose Trolley



Trolleys				
Code	Description	Weight Capacity	Wheel Type	Barcode
HT700	Easymix General Purpose Hand Trolley	200kg	Flat Free	9318428100228

- 230 x 335 x 9mm shoe
- Dimensions: 1200 (h) x 540mm (w)
- Constructed for light use and fully powder-coated
- Fully-welded frame gives maximum strength and longevity
- 250 x 70mm poly-rimmed puncture proof wheels for increased productivity
- Replacement wheel: HT-HD



200KG

Wheel Type
Flat Free

Fridge Trolleys



Trolleys				
Code	Description	Weight Capacity	Wheel Type	Barcode
FT700P	Easymix Large Furniture Hand Trolley	250kg	Flat Free	9318428100235

- 230 x 435 x 9mm shoe
- Dimensions: 1520mm (h) x 560mm (w)
- Heavy-duty construction for carrying heavy loads and fully powder-coated
- Fully-welded frame gives maximum strength and longevity
- 250 x 70mm poly rimmed puncture proof wheels for increased productivity
- Ratchet with safety strap and dolly wheels fitted as standard
- Plastic protector strips to help prevent damage to load
- Replacement wheel: PT-FF



250KG

Wheel Type
Flat Free

Fridge Trolleys



Trolleys				
Code	Description	Weight Capacity	Wheel Type	Barcode
FT700S	Easymix Large Stair Climber Trolley	250kg	Solid	9318428100228

- 230 x 435 x 9mm shoe
- Dimensions: 1520mm (h) x 560mm (w)
- Heavy-duty construction for carrying heavy loads and fully powder-coated
- Fully-welded frame gives maximum strength and longevity
- 6" solid stair-climber wheels for transporting over stairs
- Ratchet with safety strap and dolly wheels fitted as standard
- Plastic protector strips to help prevent damage to load
- Replacement wheel: FTS-WA



250KG

Wheel Type
Solid

Multi Adjustable Trolley



Trolleys				
Code	Description	Weight Capacity	Wheel Type	Barcode
MT700	Easymix Multi Purpose Adjustable Hand Trolley	200kg	Flat Free	9318428101874

- 240x330x3mm shoe
- Dimensions: 1230- 1500 (h) x 500mm (w)
- Robust construction for extra strength and fully powder-coated
- Fully-welded steel frame gives maximum strength and longevity
- 2 caster wheels for multi directional movement
- 250x70mm poly rimmed puncture proof wheels for increased productivity
- Replacement wheel: PT-FF



200KG

Wheel Type
Flat Free

EasyTilt Trolley



Trolleys				
Code	Description	Weight Capacity	Wheel Type	Barcode
ET700	Easymix EasyTilt Trolley	250kg	Pneumatic	9318428101898

- 200 x 360 x 3mm shoe
- Dimensions: 1380mm (h) x 550 (w)
- Heavy-duty construction for carrying heavy loads and fully powder-coated
- Fully-welded frame gives maximum strength and longevity
- Ergonomically designed "P" handle allows for better control with single handed use
- Fitted with a load bearing safety hook to keep items in place while moving
- The EzyTilt mechanism allows you to tilt the wheel axle into the best position for lifting and moving the load
- Replacement wheel: ETW



250KG

Wheel Type
Pneumatic

Material Handling

Wheelbarrow Spare Wheels



NSP005



WSF002



NGS



NSF006



WSP001



WST007



NST008



WWC009



NWC010

Wheelbarrow Spare Wheels

Code	Description	Dimensions	Rim	Bore Size	Barcode
WSP001	Wide Pneumatic Tyre	16x6.50-8	Steel	25mm	9318428100822
WSF002	Wide FLAT FREE Tyre	16x6.50-8	Steel	25mm	9318428100839
NSP005	Narrow Pneumatic Tyre	4.00-8	Steel	25mm	9318428100860
NSF006	Narrow FLAT FREE Tyre	4.00-8	Steel	25mm	9318428100877
WST007	Wide Tube	16x6.50-8	Tube Only	Tube Only	9318428100846
NST008	Narrow Tube	4.00-8	Tube Only	Tube Only	9318428100884
WWC009	Wide Tyre	16x6.50-8	Tyre Only	Tyre Only	9318428100853
NWC010	Narrow Tyre	4.00-8	Tyre Only	Tyre Only	9318428100891
NGS	Narrow Pneumatic (Suit BOSS barrow)	4.00-8	Steel	25mm	N/A

Trolley Spare Wheels



PT-PN



PT-FF



HT-LD



HT-HD



ETW



FTS-WA



FT700RS

Trolley Spare Wheels

Code	Description	Diameter	Tyre Width	Rim	Bore Size	Barcode
PT-PN	Pneumatic Tyre	260mm	75mm	2 Piece Steel	16mm	N/A
PT-FF	Flat Free Tyre	250mm	60mm	Steel	16mm	N/A
HT-LD	Flat Free Tyre	200mm	42mm	Steel	16mm	9318428
HT-HD	Flat Free Tyre	250mm	60mm	Steel	16mm	N/A
ETW	Pneumatic Tyre			Steel		N/A
FTS-WA	Stair Climbing Wheel	325mm	30mm	Steel	20mm	N/A
FT700RS	Ratchet Strap for Fridge Trolley	N/A	N/A	N/A	N/A	N/A



PROUDLY AUSTRALIAN ~
ESTABLISHED
1951
~ PROUDLY AUSTRALIAN

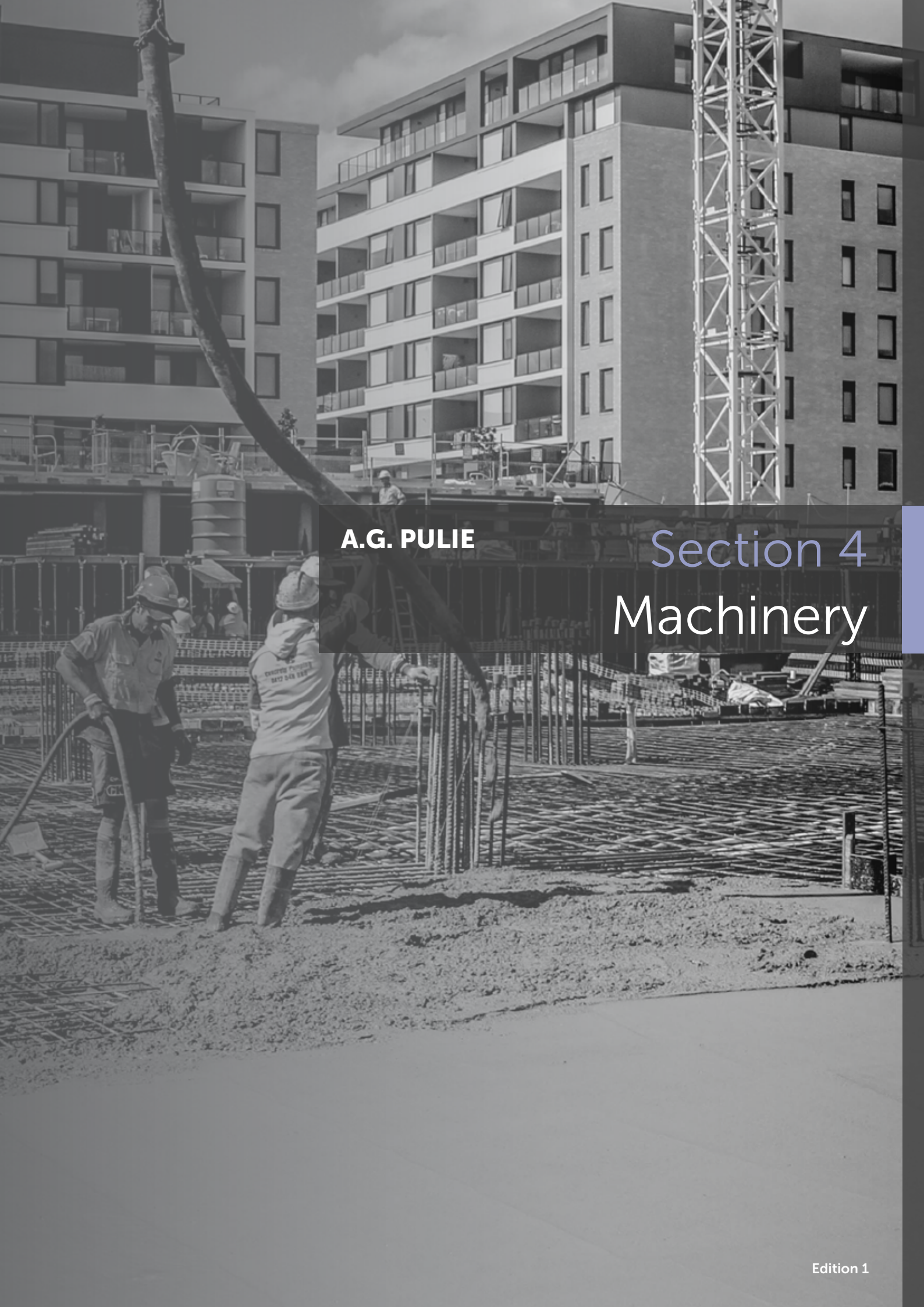

A.G. PULIE

Section 4 Machinery

Machinery

Drive Units

The Masterfinish Drive Unit will drive most makes of flexible vibration shafts and pumps. Made with a heavy-duty steel frame and spring or rubber vibrating motor mounts for extra durability. Heavy-duty 3-tooth drive dog and housing makes for a quick action connection. Dished steel base for increased mobility on site. Powered by genuine Honda GX200 4-stroke or Yanmar L48N Diesel. Local parts and service. 12 month machine warranty. 36 month Honda warranty. Available with Yanmar Diesel fitted.

**MASTER
FINISH**
by A.G. Pulie Pty Ltd

**POWERED by
HONDA™**

**3 YEAR
COMMERCIAL
ENGINE WARRANTY**

YANMAR



K1620



YK1620



K1610

Drive Units

Code	Description	Weight	Engine	Motor Mounts	Drive Dog
K1610	Rubber mounted Honda Drive Unit	25	Honda GX200	Rubber	3/4" Tooth
K1620	Spring mounted Honda Drive Unit	30	Honda GX200	Spring	3/4" Tooth
K1620L	Spring mounted Honda Drive Unit with HD Bell housing	30	Honda GX200	Spring	3/4" Tooth
YK1620	Yanmar Drive Unit	41	Yanmar L48N	Spring	3/4" Tooth

Technical Specs

Code	Power (KW)	Horse power	Capacity (cc)	Motor Speed (RPM)	Oil Level (ml)	Frame type	Fuel
K1610	4.1	5.5	200	3000	600	Half Frame	4-Stroke
K1620	4.1	5.5	200	3000	600	Full Frame	4-Stroke
K1620L	4.1	5.5	200	3000	600	Full Frame	4-Stroke
YK1620	3.5	4.7	211	3600	800	Full Frame	Diesel

Enarco Vibrating Shafts

Flexible vibration shafts provide high frequency vibration from a low flexshaft speed. The pendulum tip vibrator generates a high frequency vibration that drives out entrapped air to provide improved compaction, strength and finish of concrete. Made to endure the tough conditions of the worksite, the design and materials used in their manufacture ensures a high quality product. They can effectively compact up to 25m³/H of concrete. The flexible shaft is internally reinforced and strengthened with an integrated metallic mesh.



ENA48

Vibrating Shafts

Code	Description	Diameter (mm)	Needle Length (mm)	Length (M)	Weight (kgs)	Performance (M ³ /H)	Vibrations (v.p.m)
ENA25	Enarco Vibrating Shaft	25	300	6	16.7	5	16000
ENA38	Enarco Vibrating Shaft	38	370	6	18.1	12	12000
ENA48	Enarco Vibrating Shaft	48	430	6	20.1	17	12000
ENA58	Enarco Vibrating Shaft	58	448	6	22.2	22	12000
ENA58-9	Enarco Vibrating Shaft	58	448	9	32	22	12000
ENA58R	Enarco Vibrating Shaft with Resilient Tip	58	448	6	22.2	22	12000
ENA70	Enarco Vibrating Shaft	70	485	6	24.5	25	12000

Masterfinish Vibrating Shafts

The epicyclic design of Masterfinish Premium shaft range generates high frequency vibrations at a low flexshaft speed. This also results in a longer service life. The rotor is supported by a heavy duty self aligning bearing and generates vibration by executing a pendulum motion. The most vibration is generated at the tip of the head.



MPV57

Premium Vibrating Shafts

Code	Description	Diameter (mm)	Needle Length (mm)	Length (M)	Weight (kgs)	Performance (M ³ /H)	Vibrations (v.p.m)
MPV28	Enarco Vibrating Shaft	28	415	6	15		15000
MPV38	Enarco Vibrating Shaft	38	480	6	21		11000
MPV44	Enarco Vibrating Shaft	44	470	6	22		11000
MPV57	Enarco Vibrating Shaft	57	450	6	24		11000
MPV57-9	Enarco Vibrating Shaft	57	450	9	32		11000

Extension Shafts

Code	Description	Length (M)	Weight (kgs)
KSES	3m Shaft Extension	3	14
KSES6	6m Shaft Extension	6	22



KSES

Machinery

Masterfinish HandyVibe

No additional requirements for drive units or shafts. Ergonomic designed handle and shoulder strap. Available as standard, deluxe or resilient nose. Local parts and service. 12 month machine warranty, 6 month flex shaft warranty, 36 month Honda warranty.

**MASTER
FINISH**
by A.G. Pulie Pty Ltd

HandyVIBE

POWERED by
HONDA™

3 YEAR
COMMERCIAL
ENGINE WARRANTY



HV44

HV44E

HandyVibe

Code	Description	Weight (Kgs)	Engine	Nose Type	Diameter (mm)
HV44E	Cageless Masterfinish HandyVibe	12	Honda GX35	Hard	44
HV44	Masterfinish HandyVibe	13	Honda GX35	Hard	44
HV44RN	HandyVibe with Resilient tip	13	Honda GX35	Polyurathane	44
HV44ER	Cageless HandyVibe with Resilient tip	12	Honda GX35	Polyurathane	44

Technical Specs

Code	Frequency	Fuel	Power (KW)	Horse Power	Capacity (CC)	Oil Level (ml)	Safe-T-Cage
HV44E	9000	4-Stroke	1	1.3	35.8	100	No
HV44	9000	4-Stroke	1	1.3	35.8	100	Yes
HV44RN	9000	4-Stroke	1	1.3	35.8	100	Yes
HV44ER	9000	4-Stroke	1	1.3	35.8	100	No

Oztec Backpack Vibrator

Backpack Drive Unit

The Oztec Backpack Vibrator utilises rugged and dependable Honda petrol engines. Coupled to our "speed-up" transmission, vibrator heads develop 12,000 vpm and never drop below 10,000vpm . The BP-50a is equipped with a totally enclosed rotary throttle and a conveniently located kill switch on the same handle.



Backpack Drive Unit					
Code	Description	Engine	Weight (Kgs)	Max Power (Hp)	Fuel Type
BP-50a	Oztec Backpack Drive Unit	Honda GXH50	10.9	2.5	Petrol

Backpack Shaft

Oztec Flexible Shaft inner cores are made from extra-high carbon steel wires with casings made from tough abrasion resistant neoprene rubber, reinforced with multiple layers of high tensile wire braiding with a hardened flat steel liner. This construction makes Oztec Flexible Shafts rigid enough for driving into the stiffest concrete without kinking yet limber and non-slip for easy and effective handling.



Backpack Shaft					
Code	Description	Length (m)	Inner Core Dia (mm)	Outer Core Dia (mm)	Weight (kgs)
FS07OZ	Flexshaft for BP-50a	2.1	7.5	28	3.4
FS10OZ	Flexshaft for BP-50a	3.1	7.5	28	4.9

Backpack Vibrating Head

Oztec Vibrator Heads produce the highest amplitude and centrifugal force, generating the largest radius of influence of any heads available.

Oztec's "Rubberhead™" meets all the DOT non-metal head specifications for protecting coated rebar.



H175-OZ



HSR275-OZ

Backpack Vibrating Head					
Code	Description	Length (mm)	Diameter (mm)	Weight (kg)	Frequency
H175OZ	Vibrator Heads	355	44	4	10-12,000
HS175OZ	Vibrator Heads	152	44	2	10-12,000
HSR275OZ	Rubber Vibrator Head	152	70	2	10-12,000

Electronic Converters

The Spyder Pro electronic converter has an electronic board which can be replaced independently of the box and other components of the converter. Waterproof isolator switch prevents external fluids leaking inside. The anti-abrasion switch-cover prevents wear and tear. 15m of cable gives the equipment a high level of autonomy.



Runs in any 240V Plug



Portable Electronic Converter

Code	Description	Model	Voltage	Total Weight (kgs)
280625	SPYDER-PRO Portable Electronic Converter	SPYDER PRO 230V 50	230 V	18.6
280626	SPYDER-PRO Portable Electronic Converter	SPYDER PRO 230V 60	230 V	20.6

Technical Specs

Code	Converter Weight (kg)	Poker Diameter (mm)	Poker Length (cm)	Power (w)	Performance (M3/H)
280625	3.4	50	380	Up to 30	850
280626	3.4	58	430	Up to 35	1000'

High Frequency Generators

The Enarco High Frequency Generator is made with a genuine Honda GX160. Designed for the use of motor-in-head vibrators on site where there is no electricity supply. Engines are designed for sites that require the highest performance.



High Frequency Generators

Code	Description	Model	Total Weight	Outlets	Engine	Generator
283500	High Frequency Generator	AFGH 2000	36	2	5.5 Honda GX160	42 V3-200 HZ 1,6 KVA

Vibrating Eccentric Head*

The Enarco Vibrating Heads are available in three different diameters and are totally interchangeable. The heads are eccentric oversized steel with treated steel ends. Double seals prevent the entrance of lubricants.



TDX Dingo Shafts*

Transmission shafts with reinforced ends provide higher resistance to those points where the transmission shaft must withstand more intense bending. Strengthened by metallic mesh.



*Shaft and Head Sold Separately

Vibrating Eccentric Head

Code	Description	Model	Correspond Shaft	Diameter (mm)	Length (mm)	Weight (kg)	Performance (m ³ /H)	Vibrations R.P.M
295300	Vibrating Eccentric Head	AX 25	TAXE-TDXE	25	300	1	10	14,000
295101	Vibrating Eccentric Head	AX 40	TAX-TDX	40	335	2.2	17	13,000
295200	Vibrating Eccentric Head	AX 58	TAX-TDX	58	410	5.5	35	12,500

TDX Dingo Shafts

Code	Description	Model	Total Weight (kgs)	Length (m)	Corresponding Head
296360	TDX shaft	TDX 6M	6	8	AX48-AX58
296361	TDX shaft	TDXE 6M	6	8	AX25

Dingo Portable Electric Vibrating Motors

The Enarco portable vibrating motors come fitted with specially designed handles which create a guard against knocks. There are three handles around the motor body and another handle on the rear for use with short transmissions and upright jobs.



Electric Concrete Vibrator Motor

Code	Description	Model	Weight
296200	Electric Concrete Vibrator Motor	DINGO 230V	5.4

Technical Specs

Code	Power (W)	Voltage (V)	Frequency (HZ)	Vibrations (R.P.M)	Size (mm)
296200	2,300	230 1~	50-60	18,000	244x345x229

Motor-In-Head Pokers

The Enarco Motor-In-Head Poker vibrating head is made with a watertight system, steel reinforced tip and high quality double-bearings. The switch box, made from high-impact aluminium alloy, is robust and watertight, completely ruling out the possibility of moisture from the cement entering. The switch is also protected by a reinforced rubber washer resistant to continuous use and the wear and tear of abrasive materials. 10 metres of cable and 5 metres of hose means the operator enjoys great freedom of movement. The frequency and amplitude guarantee an optimal compaction of the concrete without any segregation of the elements composing the mass.



Motor-In-Head Poker					
Code	Description	Model	Total Weight	Diameter (mm)	Length (mm)
282002A23	Motor-In-Head Poker	M6AFP	16	58	430
Technical Specs					
Code	Frequency/Voltage	Intensity Ampere	Vibrations R.P.M	Centrifugal force (kg)	Performance (m3/h)
282002A23	200HZ 42V/3	15A	12,000	5,600	Up to 35

Tubular Converters

The Enarco Tubular Converter has a hook frame for maneuvering by crane. Built with a robust steel carriage for the protection and transportation of the converter. Equipment designed to achieve the highest performance.



Tubular Converters								
Code	Description	Model	Weight (kgs)	Outlets	Voltage Input Frequency	Power Input	Voltage Output Frequency	Power Output
285400	Tubular Converters	AFE 2000MT	32	2	230V 1-50 HZ	2	42 V3-200 HZ	1.6 KVA 23A

Pumps

Masterfinish flexible shaft-driven heavy-duty pumps are portable and can be used in a variety of applications. Available as standard premium heavy-duty pump or heavy-duty cast iron model - both with stainless steel impeller for improved abrasion resistance. Self-priming, choke resistant spindle and oil bath lubrication. Fitted with a quick action flexshaft coupling with a 3-tooth drive dog enabling them to be operated by all standard drive units. Fitted with an adaptor for cam-lock quick action hose fittings. Comes fitted with an anti-kink device; you can move the coil on the shaft to where the pump needs to go over an edge etc. to help prevent the flexible shaft from kinking. 12 month warranty on pump head; 6 month warranty on flexible shaft. Stainless steel impeller as standard.

**MASTER
FINISH**
by A.G. Pulie Pty Ltd



Submersible Pumps

Code	Description	Weight (Kgs)	Pump Head
KS212	Masterfinish Submersible Pump	32	Aluminium
KS212CI	Masterfinish Submersible Pump	35	Cast Iron

Technical Specs

Code	Impeller	Max Head Height	Discharge Dia (mm)	Max Discharge Capacity (L/hr)	Size of Solids	Shaft Length
KS212	Stainless Steel	22M @ 3600RPM	50	62000	25	6
KS212CI	Stainless Steel	22M @ 3600RPM	50	62000	25	6

Hoses

Extruded nitrile and circular woven Polyester/Nylon reinforced hose with very low expansion and elongation properties. All fittings are included.

**MASTER
FINISH**
by A.G. Pulie Pty Ltd

Lay-Flat Hose

Code	Description	Length	Barcode
LFH20	Lay-Flat delivery hose	20m	9318428101676



Machinery

Walk-Behind Road Saw

The CC1200 road saw is a robust, powerful walk-behind saw for cutting asphalt and concrete in the harsh Australian environment. Featuring a quick release pointer, steel water feed tubes for even blade cooling and a Briggs and Stratton I/C petrol engine. The 13.5hp engine provides ample power for single 18" blade or in dual cutting mode with 14" blades. In single cut mode the blade can be operated on either side of the saw.

**MASTER
FINISH**
by A.G. Pulie Pty Ltd

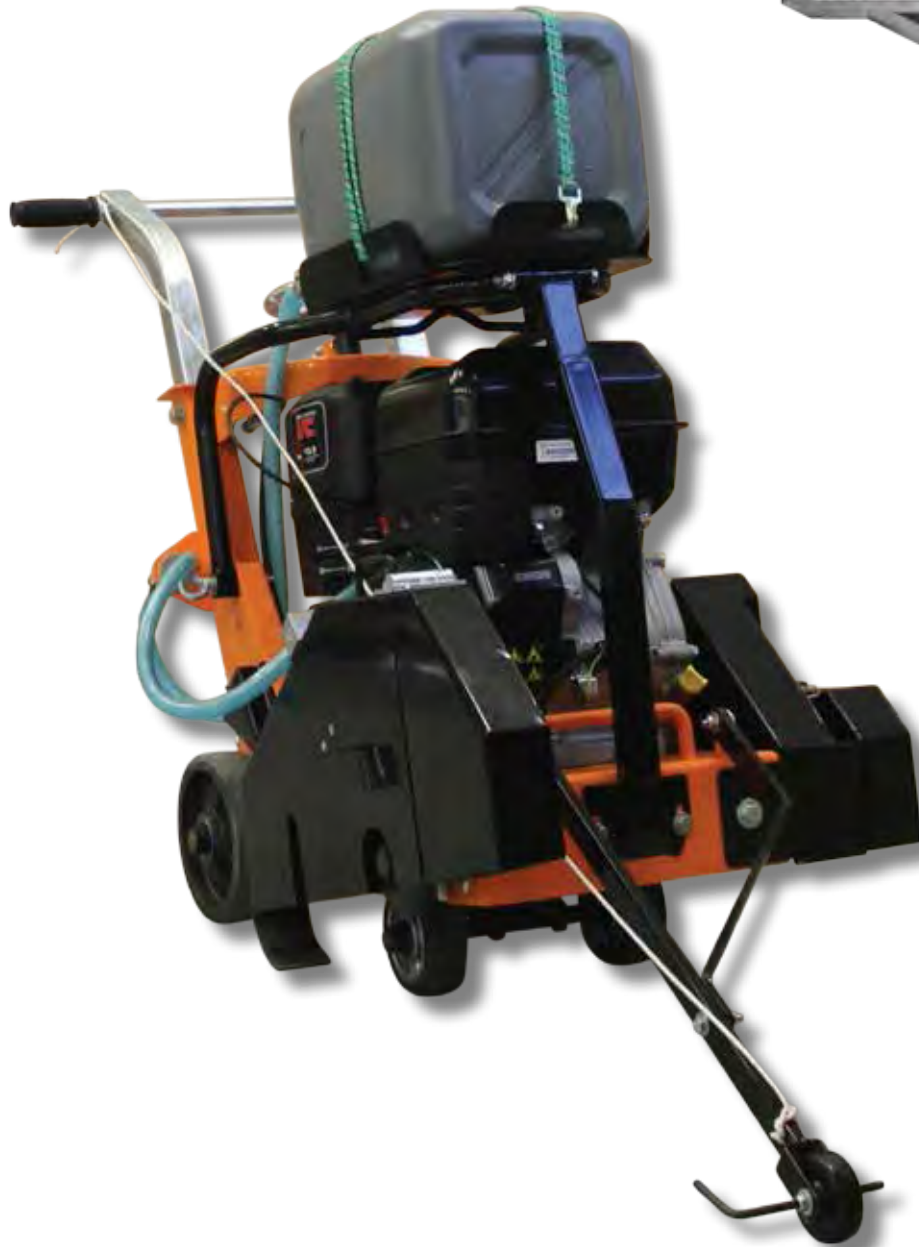

Roadsaw							
Code	Description	Max shaft height	Dual Blade Cutting Width	Width	Length	Height	Weight (dry)
CC1200	Walk Behind Road Saw	26.7mm (10.5")	50.8mm (20")	62.3cm (24")	137.7cm (54")	107.5cm (42.3")	102 kg (225lbs)
Technical Specs							
14" Blade Max Cutting Depth	18" Blade Max Cutting Depth	Max Blade Speed	Blade Arbor Diameter	Blade Shaft Diameter	Engine	Max Dual Blade Diameter	Max Blade Diameter
117mm (4 5/8")	168mm (6 5/8")	2600rpm	25.4mm (1")	31.7mm (1.25")	B&S I/C13.5hp	356mm (14")	457mm (18")

Bricksaws

The Easymix heavy-duty bricksaw runs on either a 1700W single phase motor or Honda GX200 4-stroke engine. The frame is coated with a heavy-duty zinc finish and fitted with a foot control for ease of use. The bricksaw has a mobile stand which one person can load and has high quality NSK bearings in the wheels for increased reliability. Featuring a heavy-duty tilt guide and mitre guide which is fully adjustable. Blade not included.



POWERED by HONDA™



Bricksaws

Code	Description	Engine
BS100E	Electric Bricksaw	1700w Single Phase motor
BS100P	Petrol Bricksaw	Honda GX200 4-stroke

Machinery

Floor Grinders

The Masterfinish Floor Grinder has a robust steel construction and is powered by a 2hp single phase electric motor. Fitted with a 25 meter electric cable and lifting bar. A vacuum hose can be connected to the machine for dust extraction. Fabric dust shield included as standard. Ease of control achieved by using the fingerlight wheel height adjustment. Can be fitted with a variety of discs to suit most types of abrasive segments. Minimal maintenance required - 2 grease points only. 12 month machine warranty. Grinding stones not included.

**MASTER
FINISH**
by A.G. Pulie Pty Ltd



Floor Grinders

Code	Description	Weight	Motor Size (KW)	Motor Voltage (V)	Disc Speed (RPM)	Disc Diametre (mm)	Vaccum Port Size	Number of Segments	Lead Length
G1-A	Single Disc Floor Grinder	70	1.5	240	360	350	38	3	25
G2-5	Abrasive Retainer Strips w/screws	N/A	N/A	N/A	N/A	N/A	N/A	N/A	N/A
12-17	Dust Skirt For G1-A	N/A	N/A	N/A	N/A	N/A	N/A	N/A	N/A
G2-6	Disc and Abrasive Retainers	N/A	N/A	N/A	N/A	N/A	N/A	N/A	N/A

Grinding Blocks

Code	Description	Length (mm)	long End (mm)	Short End (mm)
29	Wedge Abrasive Segment	90	78	60
WBGP	Wedge Diamond Rub	96	76	58

Cub Grinder

MasterFinish Cub Grinder has adjustable air flow that can be used with any vacuum system. Lightweight for transportation and handling, it is compactable so it stores easily. Left or right hand operated, the Masterfinish Cub Grinder is easy to control for both wet and dry grinding with a level adjustment on rear wheels for perfectly even surfaces and handling. Features a floating head dust shroud to pick up maximum dust plus height control (three positions) to cater for all operator sizes.

**MASTER
FINISH**
by A.G. Pulie Pty Ltd



HGH10

Floor Grinders

Code	Description	Weight	Motor Size (KW)	Motor Voltage (V)	Disc Speed (RPM)	Disc Diametre (mm)	Vaccum Port Size	Number of Segments
MF-CUB	Diamond Disc Floor Grinder	47	2.2	240	1450	250	51	1
HGH10	Grinding Plate	2	N/A	N/A	N/A	10"	N/A	N/A
K-CUB-006-2	Dust Skirt	N/A	N/A	N/A	N/A	N/A	N/A	N/A
K-CUB-006	Shroud	N/A	N/A	N/A	N/A	N/A	N/A	N/A

Machinery

Scarifiers

The ES8H is perfect for preparing any surface or any coating. It offers high speed, accurate surface preparation at an economical price. The ES8H uses a variety of hardened steel or Tungsten Carbide tipped cutters in cage set-ups geared for specific needs. Fitted with a Tri-tube handle for strength, isolation mounts to ease vibration, hexagonal drive shaft and sealed bearings for longer life. The MF Scarifier also features a fine cutting depth adjustment, a convenient engine stop switch and a dust control outlet. 6 month warranty on machine. 36 month Honda motor warranty. Warranty subject to conditions of use.

**MASTER
FINISH**
by A.G.Pulie Pty Ltd

**POWERED by
HONDA™**

**3 YEAR
COMMERCIAL
ENGINE WARRANTY**



Scarifier					
Code	Description	Engine	Cutting Width	Depth (per pass)	Weight (kgs)
ES8H	Masterfinish Scarifier	GX200 5.5hp Honda	<203mm (8')	<1.6mm (1/16")	61

Cutter Cages			
Code	Description	Use	Cutting Width
M200	TCT Cutter 204016.2	Milling footpaths, scabbling concrete surfaces and milling concrete joints	<203mm (8')
M300	Milling Cutter 304022	Line removal on concrete and asphalt surfaces	<203mm (8')
M400	Steel Cutter 404012	Removal of thick urethane rubber, coal tar, heavy epoxies, marine non-skid and asphalt	<203mm (8')
M500	TCT Cutter 204016.2	Concrete grooving of agricultural barns, ramps and safety grooving etc	<203mm (8')

Twin Beam Screeds

Applications include roadways, airport aprons, slipways, spillways, tilt panels and warehouse floors. The heavy-duty maintenance-free vibration unit coupled with the powerful GX200 Honda 4-stroke allows you to vibrate and screed large slabs with one pass. The vibrating screed is controlled by both the vibration propelling the machine forward and the two guide ropes on either end to keep the screed straight. Comes equipped with soft grip handles on either end for lifting and moving around site. Large one-piece motor and exciter cradle for better vibration transfer to the beams. High quality exciter. Australian made to last longer in the toughest of environments. Available in a diesel option using a Yanmar L48N 4.7hp motor. Lengths made to order. 6 month warranty on machine. 36 month Honda motor warranty.

**MASTER
FINISH**
by A.G. Pulie Pty Ltd

**POWERED by
HONDA™**

3 YEAR*
COMMERCIAL
ENGINE WARRANTY



Vibrating Screeds

Code	Description	Weight (kgs)	Length (cm)	Motor Mounts	Frequency (v.p.m)
2BVS3	Twin Beam Screed	65	3000	Rubber	4500
2BVS4	Twin Beam Screed	84	4000	Rubber	4500
2BVS6	Twin Beam Screed	132	6000	Rubber	4500

Technical Specs

Code	Force (KN)	Beam Size (mm)	Engine	Fuel	Power (kw)	Horse Power (HP)	Capacity (CC)
2BVS3	2.7	50*150 (3mm Thick)	Honda GX200	4-Stroke	4.1	5.5	200
2BVS4	2.7	50*150 (3mm Thick)	Honda GX200	4-Stroke	4.1	5.5	200
2BVS6	2.7	50*150 (3mm Thick)	Honda GX200	4-Stroke	4.1	5.5	200

Vibrating Screed

The Enarco and Easymix vibrating screeds are powered by the Honda GX35 mini 4-stroke engine. Available with beams ranging from 1.5 to 4 metres. Vibrating Screeds are made with multi-point adjustable acceleration and a transmission system with centrifugal clutch. The screed bar and frame manually separated for ease of transport whilst the handles fold down for increased storage space. The motor is raised from ground level to avoid damage and excessive amounts of concrete and dirt damaging the motor whilst the semi-rigid transmission absorbs horizontal and vertical oscillations. 12 month machine warranty and 36 month Honda warranty.

**MASTER
FINISH**
by A.G.Pulie Pty Ltd



**POWERED by
HONDA™**

**3 YEAR[†]
COMMERCIAL
ENGINE WARRANTY**

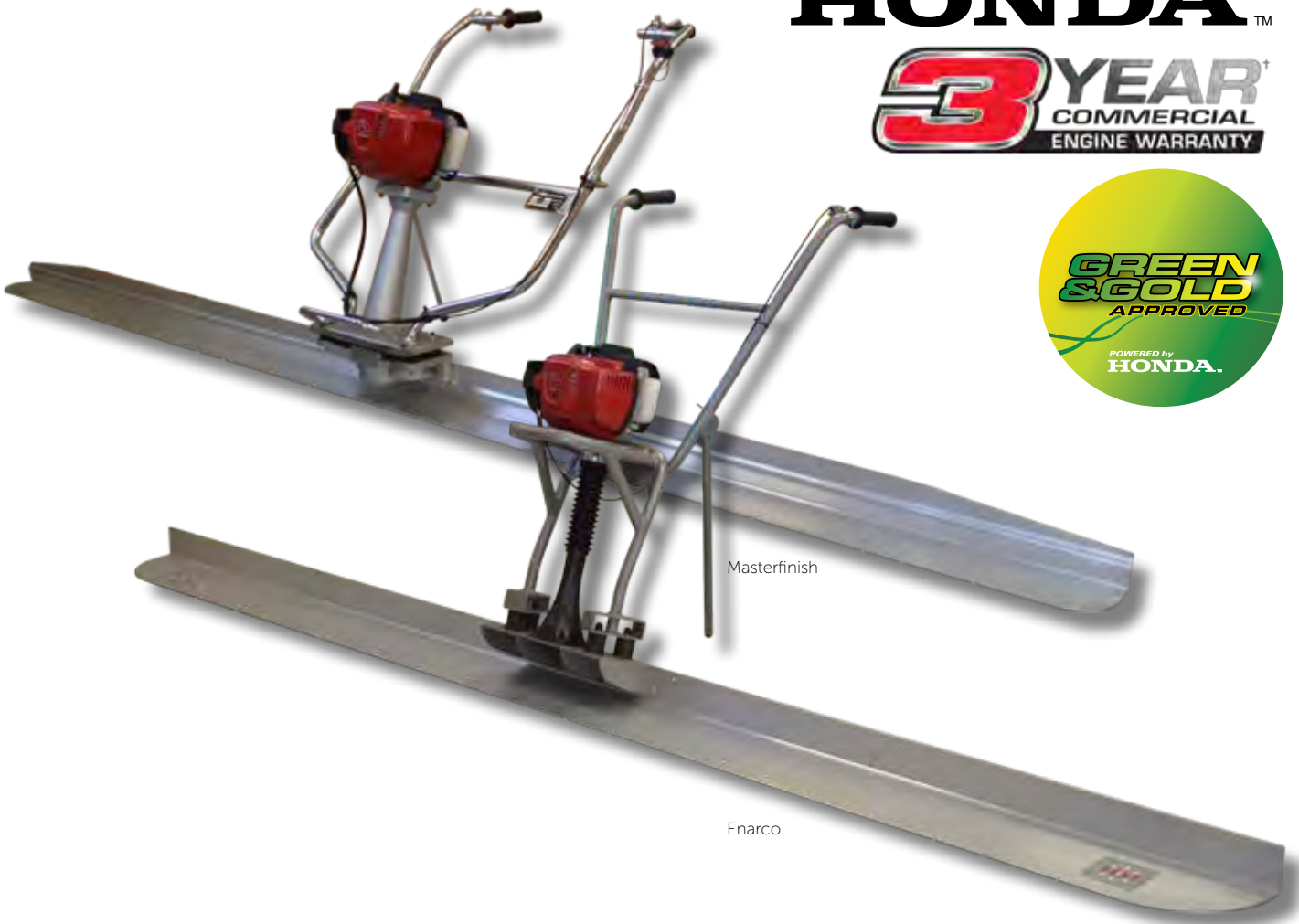

Vibrating Floating Screeds

Code	Description	Weight (kgs)	Length (cm)	Engine	Blade Size (mm)	Path (mm)
HURA1.5	Enarco Vibrating Screed	17	1500	Honda GX35	1500x200	1500
HURA2.5	Enarco Vibrating Screed	18	2500	Honda GX35	2500x200	2500
HURA3	Enarco Vibrating Screed	22	3000	Honda GX35	3000x200	3000
HURA4	Enarco Vibrating Screed	26	4000	Honda GX35	4000x200	4000
EVS2.4H	Easymix Vibrating Screed	18	2400	Honda GX35	2400x120	2400
EVS3H	Easymix Vibrating Screed	22	3000	Honda GX35	3000x120	3000

Technical Specs

Code	Fuel	Power (KW)	Horse Power (HP)	Capacity (CC)	Frequency (VPM)	Centrifugal Force (N)	Motor Oil Capacity (ml)
HURA1.5	4-Stroke	1.0	1.3	35.8	9000	2.0	100
HURA2.5	4-Stroke	1.0	1.3	35.8	9000	2.0	100
HURA3	4-Stroke	1.0	1.3	35.8	9000	2.0	100
HURA4	4-Stroke	1.0	1.3	35.8	9000	2.0	100
EVS2.4H	4-Stroke	1.0	1.3	35.8	9000	2.0	100
EVS3H	4-Stroke	1.0	1.3	35.8	9000	2.0	100

Vibrating Screed Replacement Blades

The Enarco and Easymix vibrating screed replacement blades are made from aluminium and are available in a variety of sizes ranging from 1.5 to 4 metres.

**MASTER
FINISH**
by A.G. Pulie Pty Ltd



ESB2.5

EVSB2.4

Vibration Screed Replacement Blades

Code	Description	Weight (kgs)	Length (cm)	Width (cm)
ESB1.5	Enarco Vibrating Screed	5	1500	200
ESB2.5	Enarco Vibrating Screed	6	2500	200
ESB3	Enarco Vibrating Screed	10	3000	200
ESB4	Enarco Vibrating Screed	14	4000	200
EVSB2.4	Easymix Vibrating Screed	4	2400	120
EVSB3	Easymix Vibrating Screed	8	3000	120

Machinery

Masterfinish H-Series

The Masterfinish H-Series Trowel Machine is powered by the genuine Honda GX200 4-stroke engine and is fitted with a heavy-duty gearbox and base assembly. Height adjustable handle bar stem and lifting hook as standard. 12 month machine warranty. 36 month Honda warranty. Available with Yanmar Diesel fitted.

**MASTER
FINISH**
by A.G. Pulie Pty Ltd

**POWERED by
HONDA™**

**3 YEAR¹
COMMERCIAL
ENGINE WARRANTY**



H-Series					
Code	Description	Weight (kgs)	Engine	Blade Type	Path
HS34-18	HS Series Trowel Machine	70	Honda GX200	S34-18PRE/D34-3	34"
HS40-18	HS Series Trowel Machine	72	Honda GX200	S40-18PRE/D40-2Pre	40"

Technical Specs							
Code	Fuel	Power (kw)	Horse Power (hp)	Capacity (CC)	Engine Speed (RPM)	Motor Oil Level (ml)	Gearbox Oil
HS34-18	4-stroke	4.1	5.5	200	3600	600	220 Grade Gear oil
HS40-18	4-stroke	4.1	5.5	200	3600	600	220 Grade Gear oil

Masterfinish MF-Series

The MF series trowel machines are powered by genuine Honda motors and come with a smooth pitch control for even finishing. This machine also features an emergency engine kill for operator safety if handle is released during trowelling, a lifting bar, lifting hook and a chrome guard for ease of cleaning. 12 month machine warranty. 36 month Honda warranty. Available with Yanmar Diesel fitted.

**MASTER
FINISH**
by A.G. Pulie Pty Ltd



YANMAR

**POWERED by
HONDA™**

**3 YEAR¹
COMMERCIAL
ENGINE WARRANTY**



MF-Series

Code	Description	Weight (kgs)	Engine	Blade Type	Path
MF436	MF Series Trowel Machine	77	Honda GX200	S36-10P/D36-2P	36"
MF436D	MF Series Diesel Trowel Machine	78	Yanmar L48N	S36-10P/D36-2P	36"
MF440-200	MF Series Trowel Machine	80	Honda GX200	S36-10P/D36-2P	40"
MF440	MF Series Trowel Machine	89	Honda GX270	S36-10P/D36-2P	40"
MF446	MF Series Trowel Machine	116	Honda GX270	S46-18P/D46-2P	46"

Technical Specs

Code	Fuel	Power (KW)	Horse Power (HP)	Capacity (CC)	Engine Speed (RPM)	Motor Oil Level (ml)	Gearbox Oil
MF436	4-stroke	4.1	5.5	200	3600	600	220 Grade Gear Oil
MF436D	Diesel	3.1	5.5	200	3600	600	220 Grade Gear Oil
MF440-200	4-stroke	4.1	5.5	200	3600	600	220 Grade Gear Oil
MF440	4-stroke	4.1	9	270	3600	1100	220 Grade Gear Oil
MF446	4-stroke	4.1	9	270	3600	1100	220 Grade Gear Oil

Machinery

Masterfinish MF-Series

The Masterfinish edging trowel machines are powered by the genuine Honda GX200 4-stroke and fitted with a rotating ring which allows you to finish close to walls and other structures. The edging machines also feature deadman switches for increased safety, lifting hook, folding handles for ease of transport along with handles located at the front and back of the machine to help manual handling. Local parts and service. 12 month machine warranty. 36 month Honda warranty. All MF424 and MF430-6 come with a floating pan included.

**MASTER
FINISH**
by A.G. Pulie Pty Ltd

**POWERED by
HONDA™**

**3 YEAR¹
COMMERCIAL
ENGINE WARRANTY**



MF424

MF430-6

MF-Series					
Code	Description	Weight (kgs)	Engine	Blade Type	Path
MF424	Masterfinish 24" Trowel Machine	70	Honda GX200	T600FBP	24"
MF430-6	Masterfinish 30" 6 Blade Trowel Machine	78	Honda GX200	T600FBP	30"

Technical Specs							
Code	Fuel	Power (KW)	Horse Power (HP)	Capacity (CC)	Engine Speed (RPM)	Motor Oil Level (ml)	Gearbox Oil
MF424	4-stroke	4.1	5.5	200	3600	600	220 Grade Gear oil
MF430-6	4-stroke	4.1	5.5	200	3600	600	220 Grade Gear oil

Masterfinish MF-Series

The Masterfinish Ride-On trowel machines are powered by the genuine Honda GX690 and are fitted with a durable gearbox, base assembly and water spray system. Featuring lifting points as standard, stainless steel fuel and water tank with large cap along with a chrome guard ring and fitted with work lights. 140-150rpm blade speed for final finishing. 12 month machine warranty. 36 month Honda warranty.

**MASTER
FINISH**
by A.G. Pulie Pty Ltd



**POWERED by
HONDA™**

**3 YEAR¹
COMMERCIAL
ENGINE WARRANTY**



MF-Series

Code	Description	Weight (kgs)	Engine	Blade Type	Path
MF836	Masterfinish 36" Ride-on	295	Honda GX690	D36-2P	1880mm

Technical Specs

Code	Fuel	Power (KW)	Horse Power	Capacity (CC)	Engine Speed (RPM)	Motor Oil Level (ml)	Gearbox Oil
MF836	4-stroke	13	22.1	688	3600	2000	220 Grade Gear oil

Machinery

Trowel Machine Blades

Masterfinish Blades are manufactured using specially formulated hardened and tempered spring steel. The high carbon content provides abrasion resistance for longer wear. 4 blades per pack.



Blades							
Code	Description	Length	Width	Weight	Hole Centres	Bolts (lengths vary)	Barcode
T600FBP	Premium spring steel finishing trowelling machine blade	227mm	120mm	3kgs	100mm	1/4" UNC/BSW	9318428406207
S34-18P	Premium spring steel combination trowelling machine blade	322mm	203mm	6kgs	152mm	3/8" BSW bolts	9318428333190
S34-18	Steel combination trowelling machine blade	322mm	203mm	6kgs	152mm	3/8" BSW bolts	9318428331189
S36-10P	Premium spring steel combination trowelling machine blade	355mm	203mm	8kgs	120mm	5/16" UNC HT bolts	9318428403640
S36-10	Steel Combination Trowelling machine blades	355mm	203mm	8kgs	120mm	5/16" UNC HT bolts	9318428403619
S40-18P	Premium spring steel combination trowelling machine blade	375mm	203mm	8kgs	152mm	3/8" BSW bolts	93184281404197
S40-18	Steel combination trowelling machine blade	375mm	203mm	8kgs	152mm	3/8" BSW bolts	9318428404180
S46-18P	Premium spring steel combination trowelling machine blade	456mm	203mm	10kgs	66/90/30mm	5/16" UNC HT bolts	9318428406191
D36-2P	Premium spring steel finishing trowelling machine blade	355mm	152mm	4.5kgs	120mm	5/16" UNC HT bolts	9318428403633
D40-2P	Premium spring steel finishing trowelling machine blade	375mm	152mm	5kgs	152mm	3/8 BSW bolts	9318428404036
D46-2P	Premium spring steel finishing trowelling machine blade	457mm	152mm	7kgs	66/90/30mm	5/16" UNC HT bolts	9318428405385
D34-3	Carbon steel finishing trowelling machine blade	324mm	152mm	4.5kgs	152mm	3/8 BSW bolts	9318428403435

Trowel Machine Blade Selection Guide

																	
					T600FBP	D36-2P	D40-2PRE	D46-2P	D34-3	S46-18P	S36-10P	S34-18PRE	S40-18PRE	BF36B	BF48B		
Walk Behind Power Trowels	MasterFinish	HS34	34"	4													
		HS40	40"	4													
		MF424	24"	4													
		MF430-6	30"	6													
		MF436	36"	4													
		MF440	40"	4													
	Flextool	FP424	24"	4													
		FP436	36"	4													
		FP440	40"	4													
		FP446	46"	4													
	Flextool	FT34	34"	4													
		FT40	40"	4													
	Bartell	B424	24"	4													
		B436	36"	4													
		B440	40"	4													
		B446	46"	4													
	Wacker	CT24	24"	4													
		CT36	36"	4													
		CT48	48"	4													
	Crommelins	CPT34	34"	4													
		CPT40	40"	4													
	Allen	VP424	24"	4													
		VP436 & PRO436	36"	4													
		VP446 & PRO446	46"	4													
		PRO436Edger	36"	4													
	Whiteman	HP & J Series	36"	4													
		HP & B Series	46"	4													
		HD Series	48"	4													
	Ride On Power Trowels	Flextool	FP836 / FP836-2	36"	4												
			FP846	46"	4												
			FP1046-2	46"	5												
		Allen	MP215	36"	4												
			MP225 & MP235	36"	4												
			MP305 & MP315	46"	4												
			MSP415&MSP445	46"	5												
			SP400C & SP425	46"	5												
MSP460			46"	5													
HDX600			46"	5													
Bartell		TS65	-	4													
		TS74	36"	4													
		TS78	36"	4													
		TS88	46"	4													
		TS96	46"	4													
		LP95	46"	4													
		HS90	46"	4													
		TS100	46"	4													
Wacker		CRT36	36"	4													
		CRT46	48"	5													
Whiteman		J Series	36"	4													
		H Series	48"	4													
		H Series	48"	5													

Replacement Honda Motors

Honda's GX series engines are legendary for superior reliability and performance. And there's no doubt about it! With lower noise levels, lower vibration and lower emissions - without sacrificing power output or performance, the Honda GX Series are some of the best engines in the business. The Honda GX35 is the worlds first 360° inclinable 4-Stroke engine. The GX200 has a 2 to 1 reduction rate.



GX35



GX120



GX200



GX270

Cement Mixers

Code	Engine Type	Net Power Output	Net Torque	Oil Capacity	Fuel	Fuel Capacity	Dry Weight
GX35	Honda Air-Cooled 4-Stroke OHC	1.3HP @7000RPM	1.2lb-ft @5500RPM	100cc	Unleaded 86 Octane <	0.63ltr	3.3kg
GX120	Honda Air-Cooled 4-Stroke OHV	3.5HP @3600RPM	5.4lb-ft @2500RPM	0.56ltr	Unleaded 86 Octane <	2.0ltr	13kg
GX200	Honda Air-Cooled 4-Stroke OHV	5.5HP @3600RPM	9.1lb-ft @2500RPM	0.61ltr	Unleaded 86 Octane <	3.1ltr	16.1kg
GX270	Honda Air-Cooled 4-Stroke OHV	8.5HP @3600RPM	14.1lb-ft @2500RPM	1.1ltr	Unleaded 86 Octane <	5.3ltr	25kg

POWERED by
HONDA™

3 YEAR⁺
COMMERCIAL
ENGINE WARRANTY

Machinery Replacement Parts

Handyvibe Parts

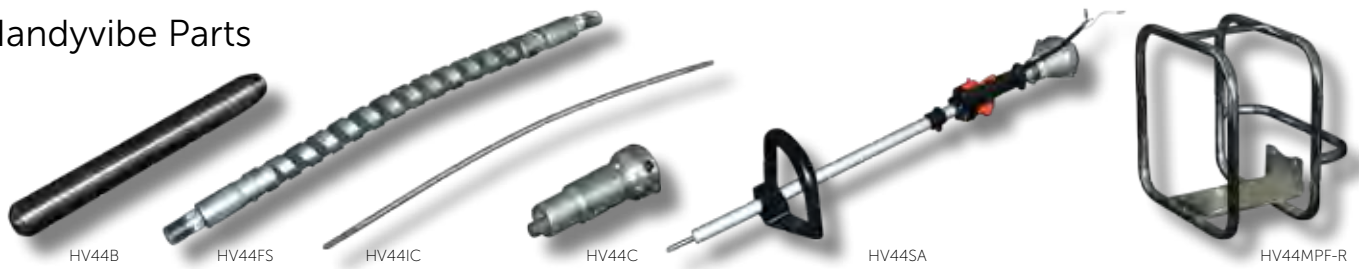

Drive Unit Parts

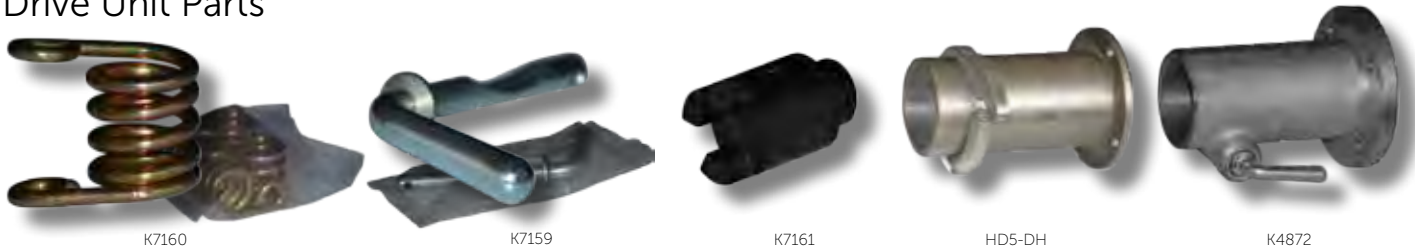

Trowel Machine Parts



Grinder Parts



Compactor Parts



Spare Parts			
Code	Machine	Description	
HV44B	Handyvibe	HandyVibe Barrel Assembly	
HV44C	Handyvibe	Coupling HV44	
HV44FS	Handyvibe	Flex Shaft Assy For HV44	
HV44MPF-R	Handyvibe	Motor Protection Frame	
HV44MPF-M/KITC	Handyvibe	Vibration Mount Kit	
HV44SA	Handyvibe	Handyvibe Stem Assy	
HV44IC	Handyvibe	Inner Core	
K7160	Drive Unit	Spring Kit	
K7161	Drive Unit	3/4" Bore Drive Dog	
K4872	Drive Unit	Bell Housing	
HD5-DH	Drive Unit	Heavy Duty Bell Housing	
K7159	Drive Unit	Trigger Kit	
550-10	Plate Compactor	Vibration Mounts	
M/COVER	Trowel Machine	Motor Cover	
T600P	24" Trowel Machine	24" Floating Pan	
30PAN6	30" Trowel Machine	30" Floating Pan	
BO38.5	36" Trowel Machine	38" Floating Pan	
BO48.5	Ride-On Machines Only	48" Floating Pan	
G2-5	Grinder	Retainer Strips	
12-17	Grinder	Dust Skirt	
K-CUB-006-2	Cub-Grinder	Dust Skirt	

Machinery

Cement Mixers

MB22 DIY Mixer

The MB22 2.2Cft Cement Mixer is made with a 3-piece tubular steel frame and is fitted with a poly motor cover and poly rimmed pneumatic tyres. The bowl is seam welded, containing six beaters and has a maintenance-free ball bearing head for the pinion and bowl. Requires assembly. 12 month machine warranty.



Cement Mixers				
Code	Description	Engine Type	Size (cft)	Barcode
MB22	2.2 DIY Mixer	1/2 HP 240V 1440rpm Single Phase Engine	2.2	9318428101461

EM22 Trade Mixer

The EM22 2.2Cft Cement Mixer is made with a heavy-duty tubular steel frame and fitted with steel Pneumatic wheels. The bowl is seam welded with six heavy-duty beaters inside and has a maintenance-free ball-bearing head for pinion and bowl. 12 month machine warranty.



Cement Mixers			
Code	Description	Engine Type	Size (cft)
EM22	2.2 Mixer	1/2 HP 240V 1440rpm Single Phase Engine	2.2

EM35 Trade Mixer

The EM35 mixer is available with either a petrol or electric motor and is made with a tubular steel frame, heavy-duty pinion and ring gear and 34mm axle. It has FLAT FREE tyres 4.80 x 4.00. The EM35 also features Premium NSK bearings, bolt-on handles with soft hand grips and all metal belt and engine covers.



POWERED by HONDA™



Cement Mixers

Code	Description	Engine Type	Size (cft)
EM35	3.5 CFT Mixer	1.1 HP electric engine	3.5
EM35H	3.5 Mixer With Honda Eng	Honda GX120	3.5

For Trestles



See Page 20

For Wheelbarrows



See Page 47-56

Machinery

T3EP Mixer - Available In WA Only

The T3EP mixer is available with either a petrol or electric motor. Built with a heavy-duty frame and bowl and uses Premium NSK bearings. Fitted with steel wheels and FLAT FREE Tyres (16 x 4.00-8). Comes standard with a fixed stand; the fatbowl and swivel stand are optional. Unloads at standard wheelbarrow height when on stand.



POWERED by HONDA™



T3EP-6



Fixed Stand



Swivel Stand



T3EP-6FBB



T3EP-10

Cement Mixers

Code	Description	Engine Type	Size (cft)
T3EP-6	3.5 Tipup Mixer w/ Fixed Stand	CMG 0.75kw Single Phase Motor	3.5
T3EP-7	3.5 Tipup Mixer w/ Swivel Stand	CMG 0.75kw Single Phase Motor	3.5
T3EP-10	3.5 Tipup Mixer w/ Fixed Stand	Honda GX200	3.5
T3EP-13	3.5 Tipup Mixer w/ Swivel Stand	Honda GX200	3.5
T3EP-6FBB	3.5 Plaster Pro Tipup Mixer Fat Bowl w/ Fixed Stand	CMG 0.75kw Single Phase Motor	3.5
T3EP-SK	Mixer Service Kit	N/A	N/A
T3EP-26	Swivel Stand	N/A	N/A
T3EP-25	Fixed Stand	N/A	N/A

EM120

The EM120 Paddle Mixer runs on a single phase voltage engine. Its ergonomic designed frame increases maneuverability, including its ability to fit through narrow door ways. Equipped with multiple exchangeable mixing paddles, the EM120 makes the perfect mix in 3-5 minutes. Also features a bag splitter for ease of pouring, telescopic legs for discharge into a bucket or wheelbarrow and small wheels on the back which allow for ease of loading in and out of vehicles.



Cement Mixers

Code	Description	Engine Type	Weight (Kgs)	Size (Ltr)	No. of Paddles
EM120	Paddle Mixer	Single Phase Voltage (110/240V)	90	120	4

CM600

The CM600A is built with a heavy-duty construction bowl and frame and is fitted with a metal engine cover. Features heavy-duty steel pneumatic wheels.



Cement Mixers

Code	Description	Engine Type	Size (cft)
CM600P	Mixer - C/W Motor	Honda GX200	6.0
CM600D	Mixer - C/W Motor	Yanmar L48N	6.0

Machinery

Plate Compactors

490HW Plate Compactor

The Easymix 490H plate compactor has a solid, high-strength steel base plate with curved edges to provide top performance. The robustly designed sealed belt cover gives great protection to both the clutch and belt. Fitted with anti-vibration removable flip-over handles for easy transportation and wheels for ease of movement around site. Comes standard with sprayer bottle.

The exciter uses 200ml of 10W-30 motor oil. 12 months machine warranty and 36 months Honda motor warranty.



Plate Compactors						
Code	Description	Weight (kgs)	Engine	Plate Width (mm)	Plate Length (mm)	Vibrating System
490HW	Plate Compactor C/W Water Sprayer	65	Honda GX200	340	490	Eccentric Rotation

Technical Specs						
Code	Centrifugal Force (KN)	Frequency (VPM)	Compaction Depth (CM)	Travel Speed (cm/sec)	Hill Climbing Ability	Motor Oil Capacity
490HW	10	5400	15 Approx	22	30° Approx	600

530HW Plate Compactor

The Easymix 530HW plate compactor has a ductile iron base plate which provides better durability. A sealed belt cover prevents sand and soil getting in. Fitted with built-in wheels and centrally located lifting bar allowing for easy transportation. The water tank is easily removed and has a built-in valve. The exciter uses 200ml of 10W-30 motor oil. 12 month machine warranty and 36 months Honda motor warranty.



Plate Compactors						
Code	Description	Weight (kgs)	Engine	Plate Width (mm)	Plate Length (mm)	Vibrating System
530HW	Plate Compactor	83	Honda GX200	500	530	Eccentric Rotation

Technical Specs						
Code	Centrifugal Force (KN)	Frequency (VPM)	Compaction Depth (cm)	Travel Speed (cm/sec)	Hill Climbing Ability	Motor Oil Capacity
530HW	13	5500	30 Approx	40	20° Approx	600

550H Plate Compactor

The Easymix 550H plate compactor has a solid, high-strength steel base plate with curved edges which provides top performance. Fitted with a lifting hook and anti-vibration flip over handle for easy transportation. The exciter is front mounted meaning the plate compactor has the ability to pull itself through softer material with greater ease. The exciter uses sealed bearings so no need for oiling. 12 month machine warranty and 36 month Honda warranty.



Plate Compactors

Code	Description	Weight (kgs)	Engine	Plate Width (mm)	Plate Length (mm)	Vibrating System
550H	Plate Compactor	98	Honda GX200	500	550	Eccentric Rotation

Technical Specs

Code	Centrifugal Force (kn)	Frequency (VPM)	Compaction Depth (cm)	Travel Speed (cm/sec)	Hill Climbing Ability	Motor Oil Capacity
550H	19.8	7000	30 Approx	33	20° Approx	600

650H and 690H Plate Compactor

The Easymix 650H and 690H plate compactor is extremely smooth and easy to use. It allows you to "float" the plate in neutral allowing you to stay in one place for extra compaction of an area. Featuring built-in transport wheels, remote throttle lever on handle and excellent antivibration control. Exciter uses 405ml of SAE15W-40 APISG motor oil. 12 month machine warranty and 36 month Honda warranty.



Plate Compactors

Code	Description	Weight (kgs)	Engine	Plate Width (mm)	Plate Length (mm)
650H	Plate Compactor	135	Honda GX200	400	650
690H	Plate Compactor	165	Honda GX200	500	690

Technical Specs

Code	Centrifugal Force (Kn)	Frequency (VPM)	Compaction Depth (cm)	Travel Speed (cm/sec)	Drive System	Motor Oil Capacity
650H	20	5400	30 Approx	22	Hydraulic	600
690H	30	5400	40 Approx	20	Hydraulic	600

610H Plate Compactor

The Easymix 610H plate compactor features a vibration isolated reversible handle for easy operation and reduced operator fatigue. The heavy-duty shock mounts reduce vibration to the upper engine and handle for more comfortable use. The excitor is centrally mounted and fully enclosed for an even spread of compactive force over the whole base plate. The excitor is grease filled and should be checked and regreased every 500hrs with Shell Alania R3 grease or equivalent. 12 month machine warranty and 36 month Honda warranty.



POWERED by
HONDA™



Plate Compactors

Code	Description	Weight (kgs)	Engine	Plate Width (mm)	Plate Length (mm)	Vibrating System
610H	HD Plate Compactor	93	Honda GX200	460	610	Eccentric Rotation

Technical Specs

Code	Centrifugal Force (Kn)	Frequency (VPM)	Compaction Depth (cm)	Travel Speed (cm/sec)	Hill Climbing Ability	Motor Oil Capacity
610H	19.8	7000	30 Approx	33	20° Approx	600

Tamping Rammers

EasyMix Tamping Rammer



The EasyMix Tamping Rammers are driven by 4-stroke petrol engines designed specially for rammers. No need to mix fuel and oil. Fitted with a heavy-duty gearbox, plastic rust-free oil tank and built-in air filtration system to provide a durable machine with a longer running life. An intergrated fuel valve provides easy starting. The heavy shock mount system reduces hand-arm vibration and improves operator comfort. Also available is a specially designed trolley kit for easy transportation. The Rammer shoe is made of a steel plate with a wooden insert that offers economical usage. A high quality, German-made polyurethane bellow, accepts more compacting force and offers a reliable lubricating system. 6 month warranty.



Tamping Rammers					
Code	Description	Weight (kgs)	Engine	Power (Kw)	
ER68H	EasyMix Tamping Rammer	68	Honda GX100	2.2	
ER75R	EasyMix Tamping Rammer	75	Robin EH12-20	3	

Technical Specs					
Code	Vibration Frequency (R.P.M)	Impact Force (kg)	Jumping Stroke (mm)	Foot Size (mm)	Oil Capacity (ml)
ER68H	650-695	1300	40-85	330x285	400
ER75R	640-680	1400	40-80	330x285	600

Meiwa Tamping Rammer

MEIWA tamper and vibratory rammers are specifically designed for easy, smooth operation. The simplified design requires little maintenance giving you higher productivity and increased availability. All models feature a low center of gravity for stability and ease of operation. Features include rubber-coated handle for increased comfort while operating, a large throttle for increased ease of use and a large rubber buffer for extra protection.



Tamping Rammers					
Code	Description	Weight (kgs)	Engine	Power (Kw)	
RTX60D	Meiwa Tamping Rammer	63	Robin EH09F	2.5	
RTX75D	Meiwa Tamping Rammer	77	Robin EH12D	2.5	

Technical Specs					
Code	Vibration Frequency (R.P.M)	Impact Force (kg)	Jumping Stroke (mm)	Foot Size (mm)	Oil Capacity (ml)
RTX60D	600 - 648	900-1100	40-60	330x270	700
RTX75D	600 - 648	1100-1300	40-60	330x270	1000

Enarco Tamping Rammer

The Enarco Tamping Rammer is designed to be suitable for a range of applications and is specially recommended for gutters and narrow areas. Built with a light, wear-resistant foot for optimum soil compaction and structural parts which are made in cast aluminium with special thermal treatments. Features a robust and ergonomic handle with incorporated wheels for easy vehicle loading and unloading.



Tamping Rammers					
Code	Description	Weight (kgs)	Engine	Power (Kw)	
PH80YD	ENAR Tamping Rammer	81	Yanmar L48	3.1	

Technical Specs					
Code	Vibration Frequency (R.P.M)	Impact Force (kg)	Jumping Stroke (mm)	Foot Size (mm)	Oil Capacity (ml)
PH80YD	700	1510	70	332x280	800





A.G. PULIE

Section 5
Formwork

Kerb and Gutter Tools



RFBA35

Slab Edge Rebate Form Bracket manufactured to make the task of forming the 150mm brick rebate on house floor slabs with ease. The bracket is adjustable to suit 35mm to 50mm timber (pre-set at 35mm).

RFB-50

Slab Edge Fixed Rebate Form Bracket manufactured to make the task of forming the 150mm brickwork rebate on house floor slabs with ease.

Steel Pegs

Machined from tough 30mm diameter steel bar and drilled with 5mm diameter holes, staggered at 90° to allow nail fixing of timber formwork.

KGB

Kerb Bow formed from 30mm X 10mm steel bar and shaped to form up 150mm splayed kerb using 50mm thick timber.

KGP-2

Kerb Plate cut to shape from steel plate to form 150mm kerb and used in conjunction with kerb bow. If 150mm straight kerb is required, the plate can be placed to form it.

Formwork			
Code	Description	Pack Qty	Barcode
RFB-50	150 Rebate Bracket	10	9318428101744
RFBA35	Adjustable Rebate Bracket (LAM/TIM)	10	9318428101805
SP18	450 Steel Form Peg	5	9318428314458
SP24	600 Steel Form Peg	3	9318428314601
SP30	750 Steel Form Peg	3	9318428314755
KGB	Kerb & Gutter Bow	10	9318428310108
KGP-2	7" K&G Plate	10	9318428310207



KGB

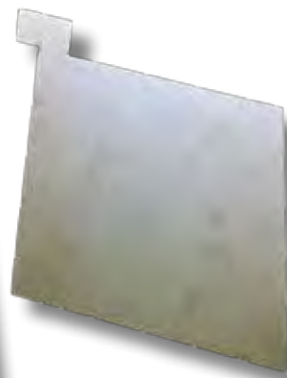

KGP-2



RFB-50



RFBA35



SP18

Wire Twister



The Schroder Wire Twister has an accurately machined spring return spiral with wear resistant bronze sleeve. Fitted with a heavy-duty, comfort grip handle, high tensile ratchet and leather bumper.

Wire Twister		
Code	Description	Barcode
90016	The Schroder Wire Twister	4012929900114



Reo Tools

Nips



These end cutting nippers are drop-forged from tool steel and additionally oil hardened. They have induction-hardened cutters that allow you to cut both hard and soft wires with ease. The cutters are also suitable for use as steel fixer's, pincers and for tying wire mesh.

Nips								
Code	Description	Length	Weight	Box Qty	Soft Wire	Medium Wire	Hard Wire	Barcode
131-12-180-SB	End Cutting Nipper	180mm	250g	6	4mm	3mm	2.4mm	4003758131275
131-12-200-SB	End Cutting Nipper	200mm	320g	6	4mm	3.5mm	2.6mm	4003758131282
115-12-220-SB	Tower Pincers	220mm	310g	6		3.2mm	1.8mm	4003758115299
115-12-250-SB	Tower Pincers	250mm	405g	6		3.4mm	2mm	4003758115213
115-12-280-SB	Tower Pincers	280mm	485g	6		3.6mm	2.2mm	4003758115220
115-12-230-KX2-SB	KX Tower Pincers	230mm	295g	6	4.2mm	3.4mm	2.4mm	4003758105214
115-12-300-KX4-SB	KX Tower Pincers	300mm	475g	6	4.5mm	4mm	2.8mm	4003758105221



131-12-180-SB



115-12-220-SB



115-12-230-KX2-SB



Rebar Bender

Strong, light, easy and simple to use. Completely portable. Can be used anywhere on the job. 36" length provides enough leverage to bend 5/8" reinforcing bar.

Rebar Bender			
Code	Description	Length	Barcode
GG629	Rebar Bender	900	765139906695



Bolt Cutters



The MCC Bolt Cutters are adaptable from soft to medium hard materials and makes a quick and easy cut on reinforcing rods and bolts. The blades are drop forged from alloy tool steel then carefully heat-treated for maximum strength and wear resistance. Unique side adjustment of blades for accuracy. All tubular handles with ductile handles.

Bolt Cutters									
Code	Description	Length	Weight	Cutting Capacity (80 HRB Rod)	Cutting Capacity (20 HRC Rod)	Cutting Capacity (36 HRC Rod)	Spare Blade	Pack Qty	Barcode
BC-0745	Alloy tool steel Bolt Cutters	450mm	1.45Kgs	8	8	6	BCE-0045	2	9318428102451
BC-0760	Alloy tool steel Bolt Cutters	600mm	2.5Kgs	10	10	8	BCE-0060	2	9318428102468
BC-0775	Alloy tool steel Bolt Cutters	750mm	3.85Kgs	13	13	10	BCE-0075	2	9318428102475
BC-0790	Alloy tool steel Bolt Cutters	900mm	5.9Kgs	16	14	11	BCE-0090	2	9318428102482
BC-0710	Alloy tool steel Bolt Cutters	1050mm	8.05Kgs	18	16	13	BCE-0010	2	9318428102444

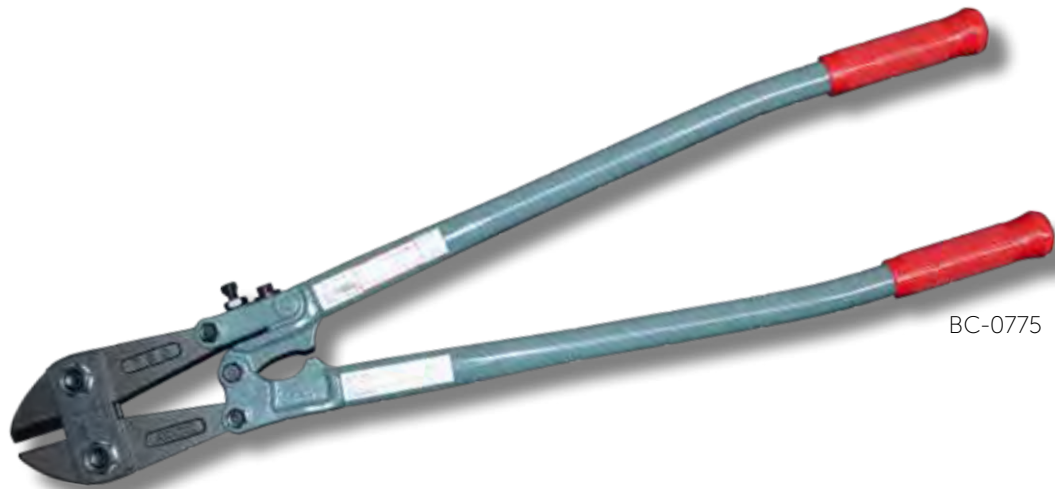

BC-0775

Reo Cutter Bender



The MCC Reo Cutter Bender is specifically designed for cutting and precision bending of reinforcing rods at 90°, 135° and 180°. Blades are drop forged from alloy tool steel. Tool can be bolted to floor or timber board for easy operation. Made in Japan.

Cutter Bender						
Code	Description	Length	Weight	Max Capacity	Spare Blade	Barcode
SCB-16	Alloy tool steel Reo Cutter Bender	1250mm	17kgs	16mm	SCBE-16	9318428500011

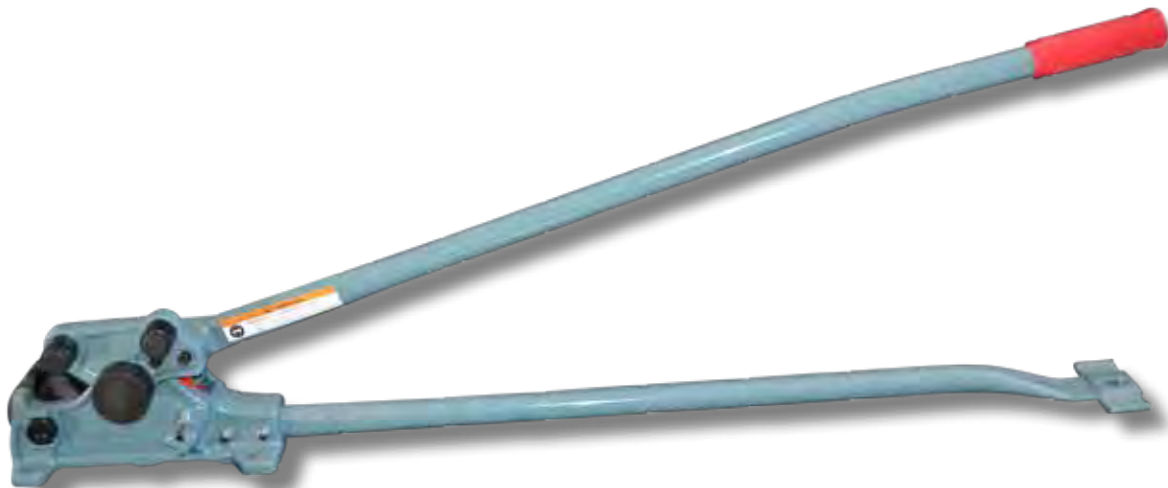

Ideal Products



Ideal Products		
Code	Description	Barcode
ID303	Leather Twister Holder	9318428101645
ID304	Leather Nip Holder	9318428101638
ID305	Leather Reel Pad	9318428101607
ID306	Large 2"HD Leather Belt	9318428101515
ID307	Medium 2" HD Leather Belt	9318428101591
ID308	Steel Nip Holder	9318428101492



ID303



ID304



ID305



ID307



ID308

The Ideal Reel



Highest quality die-cast aluminium; all steel components offer longer life. Holds 14 to 18 gauge black annealed tie wire, copper covered wire, monel wire, soft galvanized wire or stainless steel wire. Practically no maintenance; interchangeable parts available if accidentally damaged. Guaranteed against defects in workmanship or material for life.

Ideal Wire Reel			
Code	Description	Pack Qty	Barcode
ID309	Ideal Wire Reel	7	9318428500028



The Masterfinish Wire Reel



Highest quality die-cast aluminium; all steel components offer longer life. Holds 14 to 18 gauge black annealed tie wire, copper covered wire, monel wire, soft galvanized wire or stainless steel wire. Practically no maintenance; interchangeable parts available if accidentally damaged.

Masterfinish Wire Reel			
Code	Description	Pack Qty	Barcode
MF309	Masterfinish Wire Reel	10	9318428102499





PROUDLY AUSTRALIAN ~
ESTABLISHED
1951
~ PROUDLY AUSTRALIAN



A.G. PULIE

Section 6
Consumables

Masterfinish Concrete Remover



Masterfinish Concrete Remover is an acid alternative with no fumes or odours. When applied to a dry surface it turns hardset cement back into rinsable mud. M.C.R is completely biodegradable and environmentally safe. Concrete remover will save you money by protecting your equipment from the corrosive effects of concrete and acid cleaners. Complemented perfectly with the FM125 and FM5000 Birchmeier Foamers.



Concrete Remover			
Code	Description	Size	Barcode
MCR75	Masterfinish Concrete Remover	0.75ltr	9318428990744
MCR5	Masterfinish Concrete Remover	5ltr	9318428990812
MCR20	Masterfinish Concrete Remover	20ltr	9318428990980



For Foamers See Page 44

Galvanising Paints

UltraColor



A fast drying lead-free spray paint which gives a high gloss finish. Used to apply a protective zinc coating to prevent rust. The spray nozzle is adjustable for either a vertical or horizontal fan pattern.

Galvanising Paint					
Code	Description	Colour	Size	Pack Qty	Barcode
USGGY	Ultracolor Galvanising Paints	Cold Galv	250g	12	9312323990557
USGSR	Ultracolor Galvanising Paints	Silver Galv	250g	12	9312323990540



Ultracolor Survey Marking Paint

UltraColor



Available in a range of fluoro colours which best suit temporary marking. For inverted use on bitumen, concrete, grass, wood, dirt and rock. Also known as Spot Marker Paint. All Ultracolor Marking Paints are lead free.

Marking Paint					
Code	Description	Colour	Size	Pack Qty	Barcode
USMBE	Ultracolor Survey paint	Blue	350g	12	9312323001475
USMFGN	Ultracolor Survey paint	Green	350g	12	9312323001482
USMFOE	Ultracolor Survey paint	Orange	350g	12	9312323001451
USMFPK	Ultracolor Survey paint	Pink	350g	12	9312323001444
USMFRD	Ultracolor Survey paint	Red	350g	12	9312323001468
USMWE	Ultracolor Survey paint	White	350g	12	9312323001413
USMYW	Ultracolor Survey paint	Yellow	350g	12	9312323001420







A.G. PULIE

Section 7
Merchandising

Merchandising

Merchandising Stands

MasterFinish Stands				
Code	Description	Height	Width	Depth
WBD-STAND	Masterfinish Wheelbarrow Stand	280mm	320mm	420mm
G2.1SU	Masterfinish Display Stand	2100mm	1200mm	450mm
G1.5SU	Masterfinish Display Stand	1500mm	1200mm	450mm
G1.5SU	Double-Sided Masterfinish Display Stand	1500mm	1200mm	840mm
SCREED STAND	Masterfinish Screed Stand	2500mm	840mm	440mm
STARRETT STAND	Starrett Display Stand	2000mm	600mm	450mm



MFS2.1



MFS1.5



MFS1.5D



Screed Stand



The Starrett Display Stand



Wheelbarrow Stand

* All Stands are subject to availability

A.G. Pulie Shirts

MasterFinish Shirts			
Code	Description	Size	Colour
SHIRT MF	A.G. Pulie T-Shirt	Medium	Black
SHIRT MF	A.G. Pulie T-Shirt	Large	Black
SHIRT MF	A.G. Pulie T-Shirt	Extra Large	Black
SHIRT MF	A.G. Pulie T-Shirt	XX Large	Black



Masterfinish Hats

MasterFinish H ats		
Code	Description	Colour
HAT	Masterfinish Wide Brim Hat	White
CAP	Masterfinish Cap	Green
SNAPBACK	Masterfinish Snap Back Cap	Black



HAT



CAP



SNAPBACK

* All items are subject to availability and range may change





A.G. PULIE

Section 8 Index

Edition 1

Index

Index			Index		
Code	Description	Page Number	Code	Description	Page Number
010022-1	Plunger O-Ring	41	12-17	Dust Skirt For G1-A	77
010023	Barrel O-Ring	41	122A	Marble Sheen Finishing Tool	4
010546	Tank O-Ring	41	122S	Marble Sheen Finishing Tool	4
011236	Strap Clip	42	122SS	Marble Sheen Finishing Tool	4
1003	F & F Hand Held Sprayer	45	126A	Marble Sheen Finishing Tool	4
101A	Carbon Steel Pointed Trowel	2	1-2619-1	Extension Clip	40
102A	Carbon Steel Square Trowel	2	126S	Marble Sheen Finishing Tool	4
1020	Plasterer's External Edging Tool	24	126SS	Marble Sheen Finishing Tool	4
103A	Carbon Steel Pointed Trowel	2	127	Plastic Marble Sheen Float	5
1030	Plasterer's External Edging Tool	24	1-2931	Spring	40
1033	Plasterer's Internal Edging Tool	24	1-2931	Spring	41
1035	Plasterer's Square	24	131-12-180-SB	End Cutting Nipper	102
1038	MF Aluminium Plasterer's Hawk	23	131-12-200-SB	End Cutting Nipper	102
1039	MF Aluminium Plasterer's Hawk	23	1-3576	Replacement Pin	45
1040	MF Aluminium Plasterer's Hawk	23	1-3576	Pin Clip	45
10453601	Belt	46	1-4182	Retainer Ring	40
1046	Multi-Purpose Hand Sprayer	45	1-4324-1	Bottom Valve	41
1062	Masterfinish Aluminium Bullfloat	6	1572	Hair and fibre bristle timber broom	9
1063	Masterfinish Aluminium Bullfloat	6	1573	Hair and fibre bristle timber broom	9
1064	Masterfinish Aluminium Bullfloat	6	1574	Hair and fibre bristle timber broom	9
1065	Masterfinish Aluminium Bullfloat	6	1-5915	Nozzle	40
1066FP	Plastic Collet Fitting	29	1-5941	Nozzle	37
1067	Telescopic Handle Half Length	29	1-5941	Nozzle	41
1068	Masterfinish Aluminium Bullfloat	6	1-5943	Nozzle	37
1076	Telescopic Handle	29	1-5943	Nozzle	38
1076E	Swaged Adaptor	29	1-5943	Nozzle	39
1076P-4	4 Pack 1076 Pin & Clamp	29	1-5943	Nozzle	39
1076S-4	4 Pack Spring Clips	29	161A	Carbon Steel Pointed Trowel	2
1080C-2 Pack	2 Screed clamps	27	162A	Carbon Steel Square Trowel	2
1080H	Screed Handle	27	165A	Carbon Steel Pointed Trowel	2
10853203-SB	Guidage	46	17-209SOFTL	Troxell Knee Pads	33
1086	Telescopic Handle Extension	29	181A	Carbon Steel Square Trowel	2
109A	Carbon Steel Pointed Trowel	2	190A	Carbon Steel Pointed Trowel	2
109SS	Stainless Steel Pointed Trowel	2	1904Black	1974 replacement brush	9
115-12-220-SB	Tower Pincers	102	1904Blue	1974 replacement brush	9
115-12-230-KX2-SB	KX Tower Pincers	102	1904Green	1974 replacement brush	9
115-12-250-SB	Tower Pincers	102	19049	Extreme Chapin Spray	39
115-12-280-SB	Tower Pincers	102	19069	Extreme SS Chapin Spray	39
115-12-300-KX4-SB	KX Tower Pincers	102	191A	Carbon Steel Pointed Trowel	2
1155	Sponge Foam Float	24	191SS	Stainless Steel Pointed Trowel	2
1155R	Replacement foam for 1155	24	19149	13.25L Dripless Spray	38
1156	Foam Float with perforated back plate	24	192A	Carbon Steel Pointed Trowel	2
11614802	Gasket Set	46	193A	Carbon Steel Pointed Trowel	2
11617902-SB	Safety Valve	46	1949	Ind Concrete Spray 13.2Lts	37
11625301-SB	Pump	46	1974	Nylon bristle aluminium broom	9
11642701-SB	Sleeve	46	1974BLUE	Nylon bristle aluminium broom	9
11887301	Handle	46	1974GREEN	Nylon bristle aluminium broom	9
11905101-SB	Gasket Set	46	1979	H/Duty Ind Concrete Spray 12.3	38
11907101	Trigger Kit	46	1999	H/Duty Ind Spray Air Con 13.2L	40
11908201	Hose	46	201	Carbon Steel Coving Trowel	3
11910101	Air Valve	46	202	Carbon Steel Coving Trowel	3
11926201	Foam Tube	46	203	Carbon Steel Coving Trowel	3
11927401	Foam Tube	46	206	Semi Circle Trowel	12
120A	Marble Sheen Finishing Tool	4	207	Carbon Steel Coving Trowel	3
121A	Marble Sheen Finishing Tool	4	209	Stainless Steel Float	2

Index			Index		
Code	Description	Page Number	Code	Description	Page Number
209W	Stainless Steel Walking Float	13	402	Carbon Steel Edging Tool	3
219	Carbon Steel Float	2	402S	Stainless Steel Edging Tool	3
219W	Carbon Steel Walking Float	13	403	Carbon Steel Edging Tool	3
22240XP	Spray (2.0G/7.6ltr)	40	403S	Stainless Steel Edging Tool	3
22790XP	11.4 Ind OH PLB Viton	41	404	Carbon Steel Edging Tool	3
229	Carbon Steel Float	2	405	Carbon Steel Edging Tool	3
2-5582-6	Replacement Handle	40	406	Carbon Steel Edging Tool	3
2-5582-6	Handle	41	406F	Carbon Steel Edging Tool	3
26021XP	ProSeries Poly Sprayer	44	408	Carbon Steel Edging Tool	3
26031XP	ProSeries Poly Sprayer	44	410	Carbon Steel Edging Tool	3
280625	Portable Electronic Converter	71	413	Carbon Steel Bevel Edger	3
280626	Portable Electronic Converter	71	414	Carbon Steel Bevel Edger	3
282002A23	Motor-In-Head Poker	73	4163	Industrial Water Supply Tank	41
283500	High Frequency Generator	71	444	Carbon Steel Walking Trowel	5
2-8516	Replacement Rod	40	450S120	Carbon Steel Square Trowel	23
285400	Tubular Converters	73	466	Stainless Steel part ircle	12
29	Wedge Abrasive Segment	77	490HW	Plate Compactor C/W Water Sprayer	95
295101	Vibrating Eccentric Head	72	500S120	Carbon Steel Square Trowel	23
295200	Vibrating Eccentric Head	72	501	Stainless Steel Step Nosing	4
295300	Vibrating Eccentric Head	72	50137532	Valve	46
296200	Electric Concrete Vibrator Motor	72	502	Stainless Steel Step Nosing	4
296360	TDX shaft	72	530HW	Plate Compactor	95
296361	TDX shaft	72	550H	Plate Compactor	96
2BVS3	Twin Beam Screed	80	550-10	Plate Compactor	90
2BVS4	Twin Beam Screed	80	555	Carbon Steel Walking Trowel	5
2BVS6	Twin Beam Screed	80	556	Carbon Steel Walking Trowel	5
301	Carbon Steel Vee Jointer	4	557	Stainless Steel Walking Trowel	5
301014-1	Handle	40	558	Stainless Steel Walking Trowel	5
301065	Pump Assembly	37	566W-S	Heavy-Duty Red Steel Tray W/barrow	56
301191	Complete Pump	40	566W-P	Heavy-Duty Red Poly Tray W/barrow	56
301241-1	Pump Assembly	5	588	Multi Fit Clip Handle	29
301289	Pump Barrel	4	600S120	Carbon Steel Square Trowel	23
301525-1	Complete Pump	4	606	Can be locked at desired angle	5
302	Carbon Steel Vee Jointer	4	607	Fitted with bracket and tilt mechanism	5
302001	Pump Handle	88	609	Fitted with bracket and tilt mechanism	5
302001	Pump Handle	4	610H	HD Plate Compactor	97
302W	Carbon Steel Walking Vee Jointer	5	612	Fitted with bracket and tilt mechanism	5
304	Carbon Steel Vee Jointer	4	6-8138	Sprayer Handle	44
305	Carbon Steel Vee Jointer	43	61800	ProSeries B/Pack 15.1Ltrs	43
306	Carbon Steel Vee Jointer	43	6-1898	Shut-Off	41
30PAN6	30" Trowel Machine	43	1-5943	Nozzle	38
312	Carbon Steel Vee Jointer	21	6-3337	Carry Strap	37
312W	Carbon Steel Walking Vee Jointer	35	63900	Commercial Duty Backpack Sprayer	42
315	Carbon Steel Vee Jointer	39	6-4627	Repair Kit	37
3-1802	Nozzle	45	64800	Poly Backpack Diaphragm Sprayer	42
3-1853	Repair Kit	45	650H	Plate Compactor	96
3-1853-1	Viton Kit	45	6-5353	Spray Shield	40
350S150	Carbon Steel Square Trowel	23	6-5369	Relief Valve Kit	40
3-5859-1	Outlet Tube	37	6-5370	Extension Wand	40
3-7020-1	Pump Barrel	37	6-5371	Shut-off Assembly	40
3-7720	Extension Wand	37	6-5372	Nozzle	40
3-8986-1	Pump Rod	37	6-5373	Holster	37
400S150	Carbon Steel Square Trowel	23	6-5380	Shut-off Assembly	39
401	Carbon Steel Concrete Edging	3	6-5384	Repair Kit	40
401S	Stainless Steel Edging Tool	3	6-5797	Nozzle	38

Index			Index		
Code	Description	Page Number	Code	Description	Page Number
6-6062	Shut-off Assembly	37	777	Stainless Steel Variable Margin Tool	3
6-6062	Shut-Off	40	801	Wood Float	2
6-6091	Hose	37	802	Wood Float	2
6-6092	Hose	38	803	Wood Float	2
6-6136	Hose	40	804	Wood Float	2
6-6141	Hose	41	824	Wood Float	2
6-7703	Extension Wand	37	90016	The Schroder Wire Twister	101
6-7704	Extension Wand	40	901	Groover- forms semi-circular corrugations	4
6-7705	Extension Wand	39	903	Groover - semi-circular corrugations	4
6-7711	Extension Wand	40	904	Groover that forms an 8mmx16mm recess	4
6-7742	Extension Wand	41	905	Groover that forms an 8mmx16mm recess	4
6-7745	Outlet Tube	38	905E	905 with step edger	4
6-8093	Nozzle	42	ASR-0101	Aviation Snip	31
6-8096	Nozzle	42	BC-0710	Alloy tool steel Bolt Cutters	103
6-8105	Hose	42	BC-0745	Alloy tool steel Bolt Cutters	103
6-8120B	Repair Kit	42	BC-0760	Alloy tool steel Bolt Cutters	103
6-8122	Nozzle	42	BC-0775	Alloy tool steel Bolt Cutters	103
6-8130	Hose	44	BC-0790	Alloy tool steel Bolt Cutters	103
6-8131	Nozzle	43	BL210	Skate Wheel Joint Raker	19
6-8134	Pump Piston	43	BL214PF	V Sled Runner	19
6-8135	Dripless Shut-off	38	BL220PF	V Sled Runner	19
6-8136	Dripless Xtreme	38	BL260	Brick Jointer	19
6-8137	Strap	42	BL261	Brick Jointer	19
6-8138	Shut-off	42	BL262	Brick Jointer	19
6-8138	Sprayer Handle	44	BL264	Brick Jointer	19
6-8146	Filter Basket	42	BL265	Brick Jointer	19
6-8146-1	Filter	42	BL324	Mason Hammer	21
6-8148	Nozzle Kit	42	BL353	One-Piece Estwing Mash Hammer	21
6-8149	Extension Wand	42	BL526	Jumbo Utility Brush	21
6-8150	Clip	42	BO38.5	36" Trowel Machine	90
6-8151	Pressure Regulator	42	BO48.5	Ride-On Machines Only	90
6-8153	Repair Kit	42	BP-50a	Oztec Backpack Drive Unit	70
6-8167	Repair Kit	42	BS100E	Electric Bricksaw	76
6-8168	Lever Kit	43	BS100P	Petrol Bricksaw	76
6-8169	Filter	42	BT-1	Brick Trolley Straight Handles	59
6-8178	Piston	43	BT-2	Brick Trolley Curled Handles	59
6-8179	Pump Piston	43	BT700	Easymix Brick Trestles	21
6-8180	Piston Repair Kit	43	BT950	Easymix Brick Trestles	21
6-8182	Strap	42	C Plug	End plug for C screed	27
6-8183	Diaphragm Assembly	42	C1	Vee Jointer	34
6-8219	Extension Wand	43	C12	Aluminium Concrete Screed	27
6-8224	Piston	42	C12L	Aluminium Concrete Screed W/Level	27
6-8225	Collar	42	C15	Aluminium Concrete Screed	27
690H	Plate Compactor	96	C15L	Aluminium Concrete Screed W/level	27
700	Stainless Steel Edging Tool	3	C17	Bevel Edger	34
700W	Carbon Steel Walking Edger	13	C18	Aluminium Concrete Screed	27
701	Stainless Steel Edging Tool	3	C18L	Aluminium Concrete Screed W/level	27
702	Stainless Steel Edging Tool	3	C1A	Long Walking Vee Jointer	34
703	Stainless Steel Edging Tool	3	C2	Edger	34
706	Stainless Steel Edging Tool	3	C21	Aluminium Concrete Screed	27
708	Stainless Steel Edging Tool	3	C21L	Aluminium Concrete Screed W/level	27
708W	Carbon Steel Walking Edger	13	C24	Aluminium Concrete Screed	27
709	Stainless Steel Edging Tool	3	C24L	Aluminium Concrete Screed W/level	27
775	Stainless Steel Fixed Margin Tool	3	C27	Aluminium Concrete Screed	27
776	Stainless Steel Fixed Margin Tool	3	C27L	Aluminium Concrete Screed W/level	27

Index			Index		
Code	Description	Page Number	Code	Description	Page Number
C2A	Special Edger	34	CF018PF	Magnesium Blade Float	14
C2C	Bevel Edger	34	CF020PF	Magnesium Blade Float	14
C2E	Long Walking Edger	34	CF076PF	Kraft Round End Mag Float	14
C30	Aluminium Concrete Screed	27	CF112PF	Grooved Step Nosing	14
C30L	Aluminium Concrete Screed W/level	27	CF137PF	Sidewalk & Highway Edger	14
C36	Aluminium Concrete Screed	27	CF138PF	Sidewalk & Highway Edger	14
C36L	Aluminium Concrete Screed W/level	27	CF175PF	Sidewalk & Highway Edger	14
C4	Oblong Non-Skid Floor Float	34	CF207PF	Carbon Steel Finishing Trowel	15
C5	Large Edger	34	CF217PF	Carbon Steel Finishing Trowel	15
CAP	Masterfinish Cap	112	CF219PF	Carbon Steel Finishing Trowel	15
CC010	Kraft concrete rake	18	CF222PF	Carbon Steel Finishing Trowel	15
CC044-01	Magnesium Channel Float	7	CF227PF	Carbon Steel Finishing Trowel	15
CC046SR	Magnesium Channel Float	7	CF228PF	Carbon Steel Finishing Trowel	15
CC050	Magnesium Channel Float	7	CF232PF	Carbon Steel Finishing Trowel	15
CC113	Kraft Magnesium concrete rake	18	CF234PF	Carbon Steel Finishing Trowel	15
CC1200	Walk Behind Road Saw	75	CF270	20 Grit Round Rub Brick	31
CC125-01	All Angle Walking Edgers	13	CF272BPF	Blue Steel Short Shank Pool Trowel	16
CC126-01	All Angle Walking Edgers	13	CF274BPF	Blue Steel Short Shank Pool Trowel	16
CC153	Fibreglass Kneeboard	32	CF274PF	Golden Steel Pool Trowel	16
CC266	Kraft Wooden Handle	30	CF276BPF	Blue Steel Short Shank Pool Trowel	16
CC280	Bronco Tilt	9	CF276PF	Golden Steel Pool Trowel	16
CC289SB	Kraft Aluminum Button Handle	30	CF277BPF	Blue Steel Short Shank Pool Trowel	16
CC291SB	Kraft Aluminum Button Handle	30	CF277PF	Golden Steel Pool Trowel	16
CC293SB	Kraft Aluminum Button Handle	30	CF279BPF	Blue Steel Short Shank Pool Trowel	16
CC294	Ezy Tilt II	9	CF279PF	Golden Steel Pool Trowel	16
CC296	Knucklehead Bracket	9	CF282	60 Grit Rub Brick	31
CC336B	Clip Handle	30	CF283	20 Grit Rub Brick	31
CC347	All Angle Walking Groover	13	CF292BPF	Blue Steel Short Shank Pool Trowel	16
CC373	All Angle Walking Groover	13	CF295BPF	Blue Steel Short Shank Pool Trowel	16
CC623	Bronze Fresno Trowel Groover Bits	7	CF490PF	Chrome (no burn) Pool Trowel	16
CC714	Kraft Magnesium Bump Cutter	8	CF493PF	Chrome (no burn) Pool Trowel	16
CC736-01	Kraft Magnesium Bullfloat	6	CF540PF	Golden Stainless Steel Finishing Trowel	15
CC742-01	Kraft Magnesium Bullfloat	6	CF549PF	Golden Stainless Steel Finishing Trowel	15
CC750	Blue Steel "Big D" Fresno Trowel	7	CF599PF	Stainless Steel Hand Groover	14
CC751	Blue Steel "Big D" Fresno Trowel	7	CF663PF	Mini Mag Float W/PF HDL	14
CC794	Kraft Magnesium Bullfloat Groover	6	CF729BPF	Blue Steel Finishing Trowel	15
CC803-01	Kraft Magnesium Bullfloat	6	CF731BPF	Blue Steel Finishing Trowel	15
CC830	Fresno Trowel w/Ezy-Tilt Bracket	7	CF732BPF	Blue Steel Finishing Trowel	15
CC834	Fresno Trowel w/Ezy-Tilt Bracket	7	CF734BPF	Blue Steel Finishing Trowel	15
CC926	Dirt Tamper	32	CF735BPF	Blue Steel Finishing Trowel	15
CC940	Bronze Bullfloat Groover Bits	6	CF742PF	Stainless Steel Finishing Trowel	15
CC941	Bronze Bullfloat Groover Bits	6	CF744PF	Stainless Steel Finishing Trowel	15
CC942	Bronze Bullfloat Groover Bits	6	CF745BPF	Blue Steel Long Shank Pool Trowel	16
CC943	Bronze Bullfloat Groover Bits	6	CF746BPF	Blue Steel Long Shank Pool Trowel	16
CC946	Single Roller Tamp	10	CFE534PF	Kraft Elite SS Trowel	16
CC948B	Roller Tamps	10	CFE543PF	Kraft Elite Golden SS Trowel	16
CC952B	Roller Tamps	10	CM600D	Mixer - C/W Motor	94
CC958B	Roller Tamps	10	CM600P	Mixer - C/W Motor	94
CC970	Aluminum Gunite Shoe	32	D34-3	finishing blade	87
CC975	Gauge Rake	10	D36-2P	Premium finishing blade	87
CC976	Gauge Rake	10	D40-2P	Premium finishing blade	87
CF012PF	Magnesium Blade Float	14	D46-2P	Premium finishing blade	87
CF014PF	Magnesium Blade Float	14	DC363	Unomixer	31
CF015PF	Extra Wide Mag Float	14	DC408	Jiffymixer	31
CF016PF	Magnesium Blade Float	14	EAGGUN	Exposed AG Sprayer	10

Index			Index		
Code	Description	Page Number	Code	Description	Page Number
EM120	Paddle Mixer	94	FTS-WA	Stair Climbing Wheel	64
EM22	2.2 Mixer	91	FU1200	Boss Square Barrow	55
EM35	3.5 CFT Mixer	92	G1.5SU	Masterfinish Display Stand	111
EM35H	3.5 Mixer With Honda Eng	92	G1.5SU	Double-Sided Masterfinish Display Stand	111
EMKB	Easymix EPE Foam Kneeling Board	33	G1-A	Single Disc Floor Grinder	77
EMS15	Easymix Backpack Sprayer	43	G2.1SU	Masterfinish Display Stand	111
EMS15RH	Hose	43	G2-5	Abrasive Retainer Strips w/screws	77
EMS15RK	Repair Kit	43	G2-5	Grinder	90
EMS15RN	Nozzle	43	G2-6	Disc and Abrasive Retainers	77
EMS15RV	Sprayer Handle	43	GG236	Kraft Rubber Squeegee	10
EMS15RW	Wand	43	GG629	Rebar Bender	102
ENA25	Enarco Vibrating Shaft	68	GG630-56	Big John Heavy Duty Pry Bar	32
ENA38	Enarco Vibrating Shaft	68	GG631-46	Little John Pry Bar	32
ENA48	Enarco Vibrating Shaft	68	GG830	Asphalt Lute with Standard Teeth	9
ENA58	Enarco Vibrating Shaft	68	GG836	Asphalt Lute with Standard Teeth	9
ENA58-9	Enarco Vibrating Shaft	68	GG875	Asphalt Lute without Teeth	9
ENA58R	Enarco Vibrating Shaft with Resilient Tip	68	GX120	Honda Air-Cooled 4-Stroke OHV	89
ENA70	Enarco Vibrating Shaft	68	GX200	Honda Air-Cooled 4-Stroke OHV	89
ER68H	EasyMix Tamping Rammer	98	GX270	Honda Air-Cooled 4-Stroke OHV	89
ER75R	EasyMix Tamping Rammer	98	GX35	Honda Air-Cooled 4-Stroke OHC	89
ES8H	Masterfinish Scarifier	79	H175OZ	Vibrator Heads	70
ESB1.5	Enarco Vibrating Screed	82	HAT	Masterfinish Wide Brim Hat	112
ESB2.5	Enarco Vibrating Screed	82	HC177	Flexible Plastic Guniting Shoe	32
ESB3	Enarco Vibrating Screed	82	HC178	Hard Plastic Guniting Shoe	32
ESB4	Enarco Vibrating Screed	82	HD5-DH	Drive Unit	90
ET700	Easymix EasyTilt Trolley	62	HGH10	Grinding Plate	78
ETW	Pneumatic Tyre	64	HS175OZ	Vibrator Heads	70
EVS2.4H	Easymix Vibrating Screed	81	HS34-18	HS Series Trowel Machine	83
EVS3H	Easymix Vibrating Screed	81	HS40-18	HS Series Trowel Machine	83
EVSB2.4	Easymix Vibrating Screed	82	HSR275OZ	Rubber Vibrator Head	70
EVSB3	Easymix Vibrating Screed	82	HT700	Easymix General Purpose Hand Trolley	60
F Plug	End Plug for F Screed	28	HT700LD	Easymix Light Duty Hand Trolley	60
F12	Aluminium Fixed Handle Screed	28	HT-HD	Flat Free Tyre	64
F15	Aluminium Fixed Handle Screed	28	HT-LD	Flat Free Tyre	64
F18	Aluminium Fixed Handle Screed	28	HURA1.5	Enarco Vibrating Screed	81
F21	Aluminium Fixed Handle Screed	28	HURA2.5	Enarco Vibrating Screed	81
F24	Aluminium Fixed Handle Screed	28	HURA3	Enarco Vibrating Screed	81
F27	Aluminium Fixed Handle Screed	28	HURA4	Enarco Vibrating Screed	81
F30	Aluminium Fixed Handle Screed	28	HV44	Masterfinish HandyVibe	69
F36	Aluminium Fixed Handle Screed	28	HV44B	Handyvibe	90
FM125	Birchmeier Foam-Matic Foamer	46	HV44C	Handyvibe	90
FM5000	Birchmeier Foam-Matic Foamer	46	HV44E	Cageless Masterfinish HandyVibe	69
FR303A	Air Hopper Gun	32	HV44ER	Cageless HandyVibe with Resilient tip	69
FR-KIT	Repair Kit for FR303A	32	HV44FS	Handyvibe	90
FS07OZ	Flexshaft for BP-50a	70	HV44IC	Handyvibe	90
FS10OZ	Flexshaft for BP-50a	70	HV44MPF-M/KITC	Handyvibe	90
FS150	Floor scraper	17	HV44MPF-R	Handyvibe	90
FS150B	Replacement blade for FS150	17	HV44RN	HandyVibe with Resilient tip	69
FS200	Floor scraper	17	HV44SA	Handyvibe	90
FS200B	Replacement blade for FS200	17	ID303	Leather Twister Holder	104
FS300	Floor scraper	17	ID304	Leather Nip Holder	104
FS300B	Replacement blade for FS300	17	ID305	Leather Reel Pad	104
FT700P	Easymix Large Furniture Hand Trolley	61	ID306	Large 2"HD Leather Belt	104
FT700RS	Ratchet Strap for Fridge Trolley	64	ID307	Medium 2" HD Leather Belt	104
FT700S	Easymix Large Stair Climber Trolley	61	ID308	Steel Nip Holder	104

Index			Index		
Code	Description	Page Number	Code	Description	Page Number
ID309	Ideal Wire Reel	104	MF020PF	Masterfinish Mag Float	14
K1610	Honda Drive Unit	67	MF1045	Solid Concrete Rollers	9
K1620	Honda Drive Unit	67	MF1046	Solid Concrete Rollers	9
K1620L	Honda Drive Unit w/ HD BH	67	MF1047	Solid Concrete Rollers	9
K4872	Drive Unit	90	MF309	Masterfinish Wire Reel	104
K7159	Drive Unit	90	MF424	Masterfinish 24" Trowel Machine	85
K7160	Drive Unit	90	MF430-6	Masterfinish 30" 6 Blade Trowel Machine	85
K7161	Drive Unit	90	MF436	MF Series Trowel Machine	84
KCS001-N	Chalk Line	26	MF436D	MF Series Diesel Trowel Machine	84
K-CUB-006	Shroud	78	MF440	MF Series Trowel Machine	84
K-CUB-006-2	Dust Skirt	78	MF440-200	MF Series Trowel Machine	84
K-CUB-006-2	Cub-Grinder	90	MF446	MF Series Trowel Machine	84
KCX001-N	Exact Chalk Line	26	MF712	Masterfinish Channel Float	8
KCXP001-N	Chalk Box	26	MF713	Aluminium Bump Cutter	8
KCXP005-N	Exact Plus Chalk Line	26	MF713	Masterfinish Aluminium Bump Cutter	8
KGB	Kerb & Gutter Bow	101	MF836	Masterfinish 36" Ride-on	86
KGC	Kerb Coving Trowel	11	MF965	Concrete rake w/pushing profile	18
KGCT	Kerb and Gutter Crossing Trowel	11	MF999	concrete rake w/ pulling profile	18
KGE	Kerb Nosing Trowel	11	MF-CUB	Diamond Disc Floor Grinder	78
KGP-2	7" K&G Plate	101	MFKB	Masterfinish EPE Foam Kneeling Board	33
KGT	Kerb and Gutter Profile Trowel	11	MFNGO-5	Masterfinish Work Gloves	33
KI45	High-Tension Hacksaw	25	MFPP	Galvanised Steel Profile Pole	22
KS01R	10 High Carbon Steel Trapezoidal Blades	26	MFPS	Galvanised Steel Profile Pole Steady	22
KS06R	10 High Carbon Steel Break-away Blades	26	MFR500	Aluminium concrete rake	18
KS212	Masterfinish Submersible Pump	74	MFYSL	D Handle Steel Shovels	12
KS212CI	Masterfinish Submersible Pump	74	MIXER	Mixer Paddles	31
KSES	3m Shaft Extension	68	MPV28	Enarco Vibrating Shaft	68
KSES6	6m Shaft Extension	68	MPV38	Enarco Vibrating Shaft	68
KTS1-8M-N	Tape Measure	25	MPV44	Enarco Vibrating Shaft	68
KTS537-100M-N	Mega Tape Measure	25	MPV57	Enarco Vibrating Shaft	68
KTS538-15M-N	Fibreglass Metric Long Tape	25	MPV57-9	Enarco Vibrating Shaft	68
KTS538-30M-N	Fiberglass Metric Long Tape	25	MT700	Easymix Adjustable Hand Trolley	62
KTX1-8M-N	Exact Tape Measure	25	MU-0020	All Purpose Snip	31
KTXP106-8M-N	Exact Plus Tape Measure	25	NGS	Narrow Pneumatic (Suit BOSS barrow)	63
KTXP511-30M-N	Metal Body Metric Long Tape	25	NSF006	Narrow FLAT FREE Tyre	63
KUS045-N	Large Plastic Slide Locking Utility Knife	26	NSP005	Narrow Pneumatic Tyre	63
KUXP010-N	Aluminium Folding Utility Knife	26	NST008	Narrow Tube	63
LFH20	Lay-Flat delivery hose	74	NWC010	Narrow Tyre	63
LHS	Long Handle Floor scraper	17	P Plug	Straight Edge End Plug	27
LHS B7	Replacement blade for LHS	17	P12	Aluminium Straight Edge	27
LVH	Screed Handle W/Level	27	P12P	Plain Alum. Straight Edge	27
M/COVER	Trowel Machine	90	P15	Aluminium Straight Edge	27
M200	TCT Cutter 204016.2	79	P15P	Plain Alum. Straight Edge	27
M300	Milling Cutter 304022	79	P18	Aluminium Straight Edge	27
M335	Masterfinish Rubber Squeegee	10	P18P	Plain Alum. Straight Edge	27
M400	Steel Cutter 404012	79	P21	Aluminium Straight Edge	27
M500	TCT Cutter 204016.2	79	P21P	Plain Alum. Straight Edge	27
MB22	2.2 DIY Mixer	91	P24	Aluminium Straight Edge	27
MC-0020	Midget Cutter	31	P24P	Plain Alum. Straight Edge	27
MF999	Aluminium concrete rake	16	P27	Aluminium Straight Edge	27
MCR20	Masterfinish Concrete Remover	107	P27P	Plain Alum. Straight Edge	27
MCR5	Masterfinish Concrete Remover	107	P30	Aluminium Straight Edge	27
MCR75	Masterfinish Concrete Remover	107	P30P	Plain Alum. Straight Edge	27
MF011	Float Hook	12	P36	Aluminium Straight Edge	27
MF016PF	Masterfinish Mag Float	14	P36P	Plain Alum. Straight Edge	27

Index			Index		
Code	Description	Page Number	Code	Description	Page Number
PC006	Magnesium Featheredge	24	SC4Blue	Chalk Refill	26
PC007	Magnesium Featheredge	24	SC4ORG	Chalk Refill	26
PC008	Magnesium Featheredge	24	SC4RED	Chalk Refill	26
PH80YD	ENAR Tamping Rammer	98	SC4WHT	Chalk Refill	26
PL263PF	Kraft Magnesium Hawk W/PF HDL	23	SC8B	Chalk Refill	26
PL265PF	Kraft Magnesium Hawk W/PF HDL	23	SC8O	Chalk Refill	26
PL266PF	Kraft Magnesium Hawk W/PF HDL	23	SC8R	Chalk Refill	26
PL370	Kraft Yellow Cell Sponge	32	SC8W	Chalk Refill	26
PL407PF	Kraft Carbon Steel Midget Trowel	15	SCB-16	Alloy tool steel Reo Cutter Bender	103
PL447PF	Kraft Carbon Steel Drywall Trowel	23	SCREED STAND	Masterfinish Screed Stand	111
PL455PF	Kraft Golden S/S Drywall trowel	23	SF	Splayed Kerb Tool	11
PL501PF	Kraft Carbon Steel Pipe Trowel	16	SHIRT MF	A.G. Pulie T-Shirt	112
PL510PF	Kraft Aluminium Hawk	23	SHIRT MF	A.G. Pulie T-Shirt	112
PL512PF	Kraft Aluminium Hawk W/PF HDL	23	SHIRT MF	A.G. Pulie T-Shirt	112
PL513PF	Kraft Aluminium Hawk W/PF HDL	23	SHIRT MF	A.G. Pulie T-Shirt	112
PL547PF	Kraft Stainless Steel Drywall Trowel	23	SNAPBACK	Masterfinish Snap Back Cap	112
PL652	Plastic Step Tools	13	SP18	450 Steel Form Peg	101
PL653	Plastic Step Tools	13	SP24	600 Steel Form Peg	101
PL654	Plastic Step Tools	13	SP30	750 Steel Form Peg	101
PL655	Plastic Step Tools	13	STARRETT STAND	Starrett Display Stand	111
PL656	Plastic Step Tools	13	T1901-280	Poly Float	24
PL657	Plastic Step Tools	13	T1901-400	Poly Float	24
PLE457PF	Elite SS Trowel	16	T3EP-10	3.5 Tipup Mixer w/ Fixed Stand	93
PP73	Carbon Steel Square Trowel	23	T3EP-13	3.5 Tipup Mixer w/ Swivel Stand	93
PT700	Easymix P-Handle Trolley	59	T3EP-25	Fixed Stand	93
PT700FF	Easymix P Handle Trolley	59	T3EP-26	Swivel Stand	93
PT-FF	Flat Free Tyre	64	T3EP-6	3.5 Tipup Mixer w/ Fixed Stand	93
PT-PN	Pneumatic Tyre	64	T3EP-6FBB	3.5 Plaster Pro Tipup Mixer Fat Bowl	93
QTF	Carbon Steel Adhesive Spreaders	31	T3EP-7	3.5 Tipup Mixer w/ Swivel Stand	93
QTF 2	Carbon Steel Adhesive Spreaders	31	T3EP-SK	Mixer Service Kit	93
R500	Rake head for alum or timber handles	18	T600FBP	Premium steel finishing blade	87
R500H	Rake head with steel finger	18	T600P	24" Trowel Machine	90
R600R	Concrete rake profile for both	18	T876-280	Titan Rubber Sponge Float	24
RFB-50	150 Rebate Bracket	101	T960-6	Pointing Trowel	19
RFBA35	Adjustable Rebate Bracket (LAM/TIM)	101	T963-7	Gauging Trowel	19
RH	Masterfinish Timber Handle	29	T963-8	Gauging Trowel	19
RK	Roll Kerb Trowel (Pair)	11	T967-L12	Brick Trowel London Pattern	21
RO110-12SH	Rose Philadelphia Brick Trowel	20	TG1000	Thickness Gauge	10
RO112-12SH	Rose London Brick Trowel	20	TG600	Thickness Gauge	10
RO116-13SH	Rose Narrow London Brick Trowel	20	USGGY	Ultracoulour Galvanising Paints	108
RO310-12	Rose Philadelphia Brick Trowel	20	USGSR	Ultracoulour Galvanising Paints	108
RO312-12	Rose London Brick Trowel	20	USMBE	Ultracoulour Survey paint	108
RTX60D	Meiwa Tamping Rammer	98	USMFGN	Ultracoulour Survey paint	108
RTX75D	Meiwa Tamping Rammer	98	USMFOE	Ultracoulour Survey paint	108
RW-1921	Double Socket Ratchet Wrench	31	USMFPK	Ultracoulour Survey paint	108
RW-1924	Double Socket Ratchet Wrench	31	USMFRD	Ultracoulour Survey paint	108
S34-18	Premium combination blade	87	USMWE	Ultracoulour Survey paint	108
S34-18P	Premium combination blade	87	USMYW	Ultracoulour Survey paint	108
S36-10	Combination blades	87	VT600	Carbon Steel Stand Up Smoother	10
S36-10P	Premium combination blade	87	W1000	Boss Pneumatic Barrow	55
S40-18	combination blade	87	W1100	Boss Brickies Flat Tray Timber Handle	58
S40-18P	Premium combination blade	87	W12-650	SA Heavy Duty Steel Wheelbarrow	58
S46-18P	Premium combination blade	87	W250P	Handyman 100 LT Poly Tray Barrow	50
SB	Standing Bracket	5	W250S	Handyman 100 LT Stl Tray Barrow	50
SC-0200	Strap Cutter	31	W300P	Red W/Barrow with Poly Tray	51

Index		
Code	Description	Page Number
W300S	Red W/Barrow with Steel Tray	51
W400-S	Heavy-Duty Poly Narrow W/Barrow	57
W500P	Heavy Duty Narrow Pouring W/Barrow	57
W60S	Entry Level Steel Wheelbarrow	49
W700P	Green Poly Landscapers Wheelbarrow	52
W700S	Green Steel Landscapers Wheelbarrow	52
W70P	Entry Level Poly Wheelbarrow	49
W800P	Green Poly Contractors Wheelbarrow	53
W800S	Green Steel Contractors Wheelbarrow	53
W900P	Blue W/Barrow HD Poly Tray	54
W900S	Blue Steel W/Barrow HD Steel Tray	54
WBD-STAND	Masterfinish Wheelbarrow Stand	111
WBGp	Wedge Diamond Rub	77
WSF002	Wide FLAT FREE Tyre	63
WSP001	Wide Pneumatic Tyre	63
WST007	Wide Tube	63
WWC009	Wide Tyre	63
YK1620	Yanmar Drive Unit	67

Notes

A blank sheet of lined paper with a red margin line on the left side. The paper is white with light blue horizontal ruling. The red margin line is positioned approximately one-fifth of the way from the left edge. The rest of the page is empty, ready for notes.

A blank sheet of lined paper with a vertical red margin line on the left side and horizontal blue lines for writing.

A.G. Pulie Pty Ltd

ph: 02 9637 9011

fax: 02 9682 1269

sales@masterfinish.com.au

accounts@masterfinish.com.au

29 Parramatta Rd

P.O. Box 309

Granville, NSW, 2142



MASTERFINISH



Easy Mix