



OX[®]

**BORN IN
AUSTRALIA.
RAISED IN
AUSTRALIA.**

**CATALOGUE
EDITION 6**

oxtools.com



Your Account
Manager

Your Customer Care
Manager



Our story

OX Group is a world leading manufacturer of hand tools, diamond tools and safety products.

Developed and proven in Australia over the past 44 years, our tools are recognized as tough, dynamic and different across the globe.

As a manufacturer of professional tools we sell direct to the merchants, providing them with excellent service, innovative merchandising solutions and a very powerful brand.

FOLLOW US...

-  OXToolsAU
-  OXToolsAU
-  OXToolsAU

Issue date: January 2018

Subject to availability and OX Products Group AU Ltd terms and conditions of sale. All prices exclude GST, E & OE.

Contents



Diamond Tools
pages 08-35



Concreting Tools
pages 36-59



Bricklaying Tools
pages 60-73



Plastering & Rendering Tools
pages 74-93



Tiling Tools
pages 94-105



Striking & Struck Tools
pages 106-117



Measuring Tools
pages 118-121



Layout Tools
pages 122-125



Woodworking Tools
pages 126-129



Cutting Tools
pages 130-135



Plumbing & Electrical Tools
pages 136-139



Site Tools & Accessories
pages 140-147



Tool Storage
pages 148-151



Safety Equipment
pages 152-157



Merchandising
pages 158-160

15 offices, 13 countries, one **OX**



OX UK -
Europe/Middle East

- France
- Spain
- Sweden
- The Netherlands
- Italy
- Finland
- Saudi Arabia
- Argentina

OX AU -
Australasia

- New Zealand

OX USA -
North America

- Canada

World leading technology...



Look at the detail of the products – the strength and thickness of the steel, the perfect weight & balance, the positioning of the handles – guaranteed better than the rest!

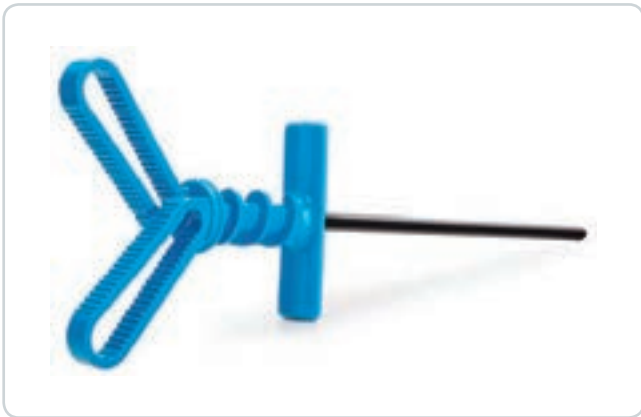

Packed with innovation, OX tools raise the benchmark for tool performance to unprecedented new levels.



A blade guaranteed to cut all masonry construction products.

OX diamond blades deliver reliability, consistency and performance everyday on the construction site.

SCAN HERE



visit oxtools.com to find out more

Whatever the level of merchandising support you need we have the answer!

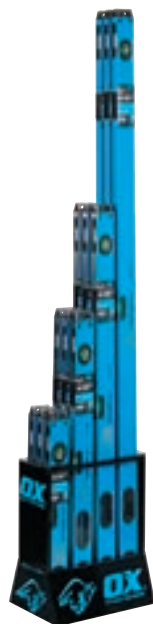

Full back up support



Demonstrations & trade shows

Staff training



Live the Trade

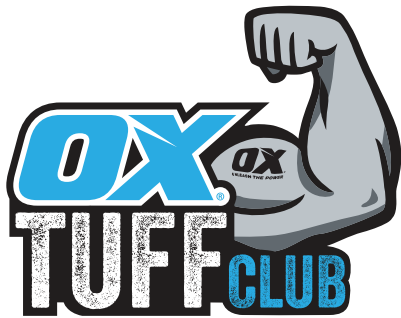

LEARN FROM THE BEST, TRAIN WITH THE BEST



Diamond Tools

OX has been innovating diamond tools for over 23 years and is now clearly recognized as one of the leading brands of choice and at the forefront of technology.

With our 23 years of experience as well as our product and market innovation, we deliver ingenious design solutions to meet ever-evolving customer requirements.

Our first class award winning diamond tools are produced in some of the world's most technically advanced laboratories and factories, guaranteeing the highest manufacturing quality.





World leading technology

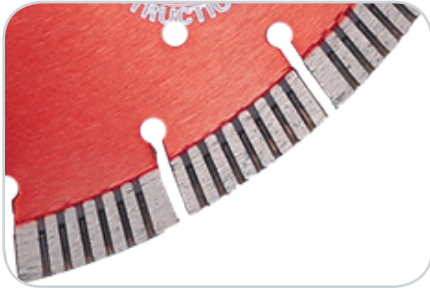

Only the finest quality of diamond is used in the production of OX blades.

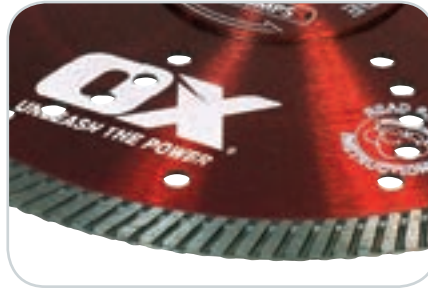

State of the art laser technology for ultimate performance and safety.

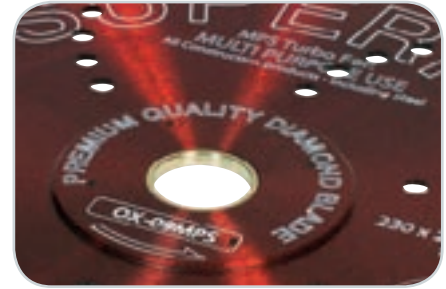

Blade & cores are made of the highest quality steel, precision engineered, ground and hardened.

Product guarantees & safety

The concept of safety is fundamental to the philosophy of the OX range. It is interwoven into the very fibre of innovation, design and production from concept to after sales service.



EN13236
All blades conform with EN13236 and have this engraved onto the reverse of the product



Full 'No Hassle' Guarantee
Covers all OX products



Diamond Innovation
Ongoing development provides increased performance on existing products, and innovative new diamond solutions.



Safety Instructions
Products undergo rigorous safety and vibration testing at our research & development facility, and in the field.



Hand/Arm Vibration
OX products were among the first to be tested and certified safe for hand/arm vibration.



Extra Safe
Our safety policy is an integral part of our company ethos with policies incorporating ISO18001.



Environmental
Showing that we care: Manufacturing operations accredited to ISO 14001 environmental systems.

We have a responsibility. Quality control systems and environmental and safety management ensure that our care covers not only our products and our customers – but that our ethical guidelines address issues such as staff safety and care for the environment.

Refer page 161 - 165 for the Diamond Trouble Shooting Guide



RECOMMENDATION GUIDE

For specific advice, refer to your supplier

APPLICATION GUIDE	DU10	DC10	TU10	TC10	TB10	TA10	MPS	MPSS	LCO	PB10	PA10	UC10	UB10	UA10
Aerated Concrete	👍	👍	👉	👍	👍	👍	👉	👉	👍	👍	👍	👍	👍	👍
Alumina	👎	👎	👎	👎	👎	👎	👎	👎	👎	👎	👎	👎	👎	👎
Asphalt / Bitumen	👎	👎	👎	👎	👉	👍	👎	👎	👎	👉	👍	👎	👉	👍
Bluestone	👎	👉	👍	👎	👎	👎	👍	👍	👉	👎	👎	👉	👎	👎
Brick - Clay	👎	👉	👍	👎	👎	👎	👍	👍	👎	👎	👎	👎	👎	👎
Brick - Concrete	👉	👉	👉	👍	👍	👍	👉	👉	👉	👍	👉	👉	👍	👎
Brick - Lightweight	👍	👉	👉	👍	👍	👉	👉	👉	👍	👍	👉	👍	👍	👉
Brick - Refractory	👎	👉	👉	👎	👎	👎	👍	👍	👎	👎	👎	👎	👎	👎
Ceramic Tiles - General	👎	👎	👎	👎	👎	👎	👎	👎	👎	👎	👎	👎	👎	👎
Ceramic Tiles - Fully Vitrified	👎	👎	👎	👎	👎	👎	👎	👎	👎	👎	👎	👎	👎	👎
Cement - Sheetting	👍	👉	👍	👉	👉	👎	👍	👍	👉	👉	👎	👉	👉	👎
Cement - Block	👍	👉	👉	👍	👍	👍	👉	👉	👉	👍	👉	👉	👍	👉
Cement - Roof Tiles	👉	👉	👉	👍	👍	👍	👉	👉	👉	👍	👉	👉	👍	👉
Cement - Pipe	👉	👉	👉	👍	👍	👎	👉	👉	👍	👉	👎	👍	👉	👎
Concrete - Cured	👉	👉	👉	👍	👉	👉	👉	👉	👍	👉	👎	👍	👉	👎
Concrete - Cured Reinforced	👎	👎	👉	👍	👉	👎	👉	👉	👍	👉	👎	👍	👉	👎
Concrete - Green	👎	👎	👎	👎	👉	👍	👉	👉	👎	👉	👍	👎	👉	👍
Concrete - Lightweight	👍	👍	👉	👍	👍	👍	👉	👉	👍	👉	👉	👍	👍	👉
Demolition Work	👎	👉	👍	👎	👎	👎	👍	👍	👎	👎	👎	👎	👎	👎
Engineered Stone	👎	👎	👎	👎	👎	👎	👎	👎	👎	👎	👎	👎	👎	👎
Fibreglass	👎	👎	👉	👎	👎	👎	👉	👎	👎	👎	👎	👎	👎	👎
Fibre Cement Sheet	👍	👍	👍	👉	👉	👎	👍	👍	👉	👉	👎	👉	👉	👎
Granite	👎	👉	👍	👎	👎	👎	👍	👍	👎	👎	👎	👉	👎	👎
Glass	👎	👎	👎	👎	👎	👎	👎	👎	👎	👎	👎	👉	👎	👎
Limestone	👎	👉	👍	👎	👉	👎	👍	👍	👉	👉	👎	👍	👉	👍
Mortar	👎	👎	👎	👎	👉	👍	👎	👎	👎	👉	👍	👎	👉	👎
Marble	👎	👎	👎	👎	👎	👎	👎	👎	👎	👎	👎	👎	👎	👎
Porcelain	👎	👎	👎	👎	👎	👎	👎	👎	👎	👎	👎	👎	👎	👎
Roof Tiles - Clay	👎	👍	👍	👎	👎	👎	👍	👍	👉	👎	👎	👉	👎	👎
Roof Tiles - Cement	👉	👉	👎	👉	👍	👎	👉	👉	👎	👍	👎	👉	👍	👉
Sandstone	👉	👉	👉	👉	👉	👍	👉	👉	👉	👍	👍	👉	👍	👍
Slate	👉	👍	👍	👎	👎	👉	👍	👍	👍	👉	👎	👍	👉	👎
Steel	👎	👎	👉	👎	👎	👎	👉	👎	👎	👎	👎	👎	👎	👎
Terracotta	👎	👎	👎	👎	👎	👎	👎	👎	👎	👎	👎	👎	👎	👎
Terrazzo	👎	👎	👎	👎	👎	👎	👎	👎	👎	👎	👎	👎	👎	👎
Wall Chasing	👉	👎	👉	👉	👉	👎	👎	👎	👉	👉	👎	👉	👉	👎
LEGEND			Will Cut Well			👍	Will Cut			👉	Will Not Cut			👎



Refer page 161 - 165 for the Diamond Trouble Shooting Guide

APPLICATION GUIDE	THB	TCB	TSB	MPSS	PHB	PCB	PSB	PHBS	PCBS	PSBS	PSF	UCF	UBF	UAF
Aerated Concrete	👎	👉	👍	👉	👉	👉	👍	👉	👉	👍	👉	👍	👍	👍
Alumina	👎	👎	👎	👎	👎	👎	👎	👎	👎	👎	👎	👎	👎	👎
Asphalt / Bitumen	👎	👎	👉	👉	👎	👎	👎	👎	👎	👎	👍	👎	👉	👍
Bluestone	👉	👉	👎	👉	👍	👉	👎	👍	👉	👎	👎	👉	👎	👎
Brick - Clay	👍	👍	👉	👍	👍	👉	👎	👍	👉	👎	👎	👎	👎	👎
Brick - Concrete	👉	👍	👍	👉	👎	👉	👍	👎	👉	👍	👍	👉	👍	👎
Brick - Lightweight	👉	👉	👍	👉	👎	👉	👍	👎	👉	👍	👍	👍	👍	👉
Brick - Refractory	👉	👉	👎	👉	👎	👎	👎	👎	👎	👎	👎	👎	👎	👎
Ceramic Tiles - General	👎	👎	👎	👉	👎	👎	👎	👎	👎	👎	👎	👎	👎	👎
Ceramic Tiles - Fully Vitrified	👎	👎	👎	👉	👎	👎	👎	👎	👎	👎	👎	👎	👎	👎
Cement - Sheetting	👍	👉	👉	👍	👉	👉	👉	👉	👉	👉	👉	👉	👉	👎
Cement - Block	👎	👉	👍	👉	👎	👉	👍	👎	👉	👍	👍	👉	👍	👉
Cement - Roof Tiles	👎	👍	👍	👉	👎	👉	👍	👎	👉	👍	👉	👉	👍	👉
Cement - Pipe	👎	👉	👍	👉	👉	👉	👉	👉	👉	👉	👉	👍	👉	👎
Concrete - Cured	👎	👉	👉	👉	👉	👉	👉	👉	👉	👉	👉	👉	👉	👎
Concrete - Cured Reinforced	👎	👉	👉	👉	👉	👉	👉	👉	👉	👉	👉	👉	👉	👎
Concrete - Green	👎	👎	👎	👉	👎	👎	👉	👎	👎	👉	👍	👎	👉	👍
Concrete - Lightweight	👎	👉	👍	👉	👎	👉	👉	👎	👉	👉	👍	👍	👍	👉
Demolition Work	👎	👉	👎	👍	👎	👉	👎	👎	👉	👎	👉	👎	👎	👎
Engineered Stone	👎	👉	👉	👉	👉	👉	👉	👉	👉	👉	👎	👎	👎	👎
Fibreglass	👎	👎	👎	👎	👎	👎	👎	👎	👎	👎	👎	👎	👎	👎
Fibre Cement Sheet	👍	👉	👉	👍	👉	👉	👉	👉	👉	👉	👉	👉	👉	👎
Granite	👉	👎	👎	👍	👉	👎	👎	👉	👎	👎	👎	👎	👎	👎
Glass	👎	👎	👎	👎	👎	👎	👎	👎	👎	👎	👎	👎	👎	👎
Limestone	👎	👉	👉	👉	👎	👉	👍	👎	👉	👍	👍	👉	👉	👎
Mortar	👎	👎	👉	👉	👎	👉	👉	👎	👎	👎	👉	👎	👉	👍
Marble	👎	👎	👎	👉	👎	👎	👎	👎	👎	👎	👎	👎	👎	👎
Porcelain	👎	👎	👎	👉	👎	👎	👎	👎	👎	👎	👎	👎	👎	👎
Roof Tiles - Clay	👍	👍	👎	👍	👍	👉	👎	👍	👉	👎	👎	👉	👎	👎
Roof Tiles - Cement	👉	👉	👍	👉	👎	👉	👍	👎	👉	👍	👍	👉	👍	👎
Sandstone	👎	👉	👉	👉	👎	👎	👍	👎	👎	👍	👍	👉	👍	👍
Slate	👎	👉	👎	👍	👍	👉	👉	👍	👉	👉	👎	👍	👉	👎
Steel	👎	👎	👎	👎	👎	👎	👎	👎	👎	👎	👎	👎	👎	👎
Terracotta	👎	👎	👎	👉	👍	👉	👎	👍	👉	👎	👎	👎	👎	👎
Terrazzo	👎	👎	👉	👉	👎	👉	👍	👎	👉	👍	👎	👎	👎	👎
Wall Chasing	👉	👉	👉	👉	👉	👉	👉	👉	👉	👉	👎	👉	👉	👎
LEGEND				Will Cut Well	👍	Will Cut	👉	Will Not Cut		👎				



Blade selection & presentation



Performance Classes

STANDARD SERIES

Entry level contractor range – an industry benchmark.

TRADE SERIES

Exceptional value for the price conscious buyer who wants something better.

PRO SERIES

The award winning, best selling superior blades – including the MPS – the best all round builders blade on the market.

ULTIMATE SERIES

When nothing but the best will do. 'Ultimate' says it all.

Refer page 161 - 165 for the Diamond Trouble Shooting Guide



Material Classes

U CLASS

UNIVERSAL HARD

Hard materials & metal
Fast cutting universal
Hard natural stone
Clay products
Engineering bricks

C CLASS

CONCRETE / GENERAL PURPOSE

Concrete & concrete
products
General purpose
Unabrasive products
Building products

B CLASS

ABRASIVE / GENERAL PURPOSE

Abrasive materials
Concrete & asphalt
Dual purpose
Concrete products
Concrete roof tiles

A CLASS

ASPHALT

Asphalt & extremely
abrasive products
Cement screed
Lignacite blocks.

QUALITY: **STANDARD SERIES**

prefix: D



DU10



DC10

QUALITY: **TRADE SERIES**

prefix: T



TU10



TC10



TB10



TA10

QUALITY: **PRO SERIES**

prefix: P



MPS



LCO



PB10



PA10

QUALITY: **ULTIMATE SERIES**

prefix: U



UC10



UB10



UA10

Logical separation of each different diamond blade into different material classes

Very clear quality bands



Angle Grinders & Demolition Saws

The STANDARD Series gives the benefit of a safe performing product for the cost conscious user.



STANDARD DU10 GENERAL PURPOSE

Best selling general purpose blade with robust 10mm segment height.
Applications include: bricks and slabs, concrete pavers, roof tiles, concrete products.

Product code	Barcode	Diameter (in)	Bore (mm)	RPM	Inner Qty	Outer Qty
OX-DU10-4	9341231024030	4	16	14500	6	24
OX-DU10-4.5	9341231024047	4 1/2	22.2/20	13200	6	24
OX-DU10-5	9341231024054	5	22.2/20	12000	6	24
OX-DU10-9	9341231030918	9	25.4/22.2	6600	6	24

OX DC10: setting the standard

The DC10 remains the No. 1 standard general purpose blade and an industry benchmark for our competitors to aspire to. Robust 10mm segment height gives an increased life of 43% over the original 7mm segment.



STANDARD DC10 GENERAL PURPOSE

Best selling general purpose blade with robust 10mm segment height.
Applications include: bricks and slabs, concrete pavers, roof tiles, concrete products.

Product code	Barcode	Diameter (in)	Bore (mm)	RPM	Inner Qty	Outer Qty
OX-DC10-4	9341231003608	4	16	14500	6	24
OX-DC10-4.5	9341231003615	4 1/2	22.2/20	13200	6	24
OX-DC10-5	9341231003622	5	22.2/20	12000	6	24
OX-DC10-7	9341231003646	7	25.4/22.2	8500	4	12
OX-DC10-9	9341231003660	9	25.4/22.2	6600	6	24
OX-DC10-14	9341231003684	14	25.4/22.2	5400	5	10
OX-DC10-16	9341231003691	16	25.4/22.2	4800	5	10



TRADE TU10 UNIVERSAL/HARD

Fast cutting universal blade, with 10mm segment height. Features super fast turbo segment and cooling holes. CUTS IT ALL – GUARANTEED. Applications include: concrete products, clay products, granite, engineering bricks, building products.



Product code	Barcode	Diameter (in)	Bore (mm)	RPM	Inner Qty	Outer Qty
OX-TU10-4	9341231002007	4	16	14500	6	24
OX-TU10-4.5	9341231002014	4 ½	22.2/20	13200	6	24
OX-TU10-5	9341231002021	5	22.2/20	12000	6	24
OX-TU10-6	9341231002038	6	25.4/20	10200	6	24
OX-TU10-7	9341231002045	7	25.4/22.2	8500	4	12
OX-TU10-8	9341231002052	8	30/25.4	7600	3	6
OX-TU10-9	9341231002069	9	25.4/22.2	6600	6	24
OX-TU10-14	9341231002083	14	25.4/20	5400	5	10

TRADE TC10 CONCRETE

The general purpose blade with a 10mm segment height. All round performance. Applications include: building products, general purpose, kerbs and slabs, concrete pavers and blocks, roof tiles.



Product code	Barcode	Diameter (in)	Bore (mm)	RPM	Inner Qty	Outer Qty
OX-TC10-4	9341231002106	4	16	14500	6	24
OX-TC10-4.5	9341231002113	4 ½	22.2/20	13200	6	24
OX-TC10-5	9341231002120	5	22.2/20	12000	6	24
OX-TC10-7	9341231002144	7	25.4/22.2	8500	4	12
OX-TC10-9	9341231002168	9	25.4/22.2	6600	6	24
OX-TC10-12	9341231002175	12	25.4/20	5100	2	5
OX-TC10-14	9341231002182	14	25.4/20	5400	5	10
OX-TC10-16	9341231020346	16	25.4/20	4800	5	10

TRADE TB10 ABRASIVE/GENERAL PURPOSE

Abrasive and general purpose blade with 10mm segment height. Applications include: general and abrasive building products, concrete pavers, concrete roof tiles, hard asphalt, breeze blocks.



Product code	Barcode	Diameter (in)	Bore (mm)	RPM	Inner Qty	Outer Qty
OX-TB10-4	9341231002205	4	16	14500	6	24
OX-TB10-4.5	9341231002212	4 ½	22.2/20	13200	6	24
OX-TB10-5	9341231002229	5	22.2/20	12000	6	24
OX-TB10-6	9341231002236	6	25.4/20	10200	3	6
OX-TB10-7	9341231002243	7	25.4/22.2	8500	4	12
OX-TB10-8	9341231002250	8	30/25.4	7600	3	6
OX-TB10-9	9341231002267	9	25.4/22.2	6600	6	24
OX-TB10-12	9341231002076	12	25.4/20	5100	2	5
OX-TB10-14	9341231002281	14	25.4/20	5400	5	10
OX-TB10-16	9341231002298	16	25.4/20	4800	5	10

TRADE TA10 ASPHALT

Asphalt blade with 10mm segment height and wedge undercut protection. Applications include: asphalt and extremely abrasive materials, render.



Product code	Barcode	Diameter (in)	Bore (mm)	RPM	Inner Qty	Outer Qty
OX-TA10-14	9341231002311	14	25.4/20	5400	5	10



Angle Grinders & Demolition Saws

The blade that is...

GUARANTEED

To cut ALL masonry construction products!

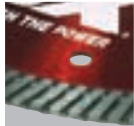

SUPERFAST TURBO segment technology combines aggressive cutting ability with a fine, clean cut and no burning of the segments. Eliminating the possibility of single segment detachment.



REINFORCED, EXTRA SECURE, DUAL CENTRE FLANGE AND UNIQUE COOL-FAST DESIGN for a quieter, cooler and safer blade, with no distortion in the cut.

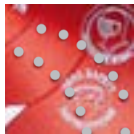

In use, the blade is semi-transparent and cuts out much of the vibration associated with conventional diamond tools.



Safety and vibration tested to meet and surpass relevant standards. Conforms with EN13236.



CUTS EVERYTHING ON A CONSTRUCTION SITE!

PRO MPS UNIVERSAL/HARD

Guaranteed to cut all masonry construction products including metal. Excellent fast cut on universal & hard materials. Reinforced flange. Cooling holes. Semi-transparent. Applications include: granite, natural stone, clay products, engineering bricks, metal, concrete products, all building materials. Wear will increase on abrasive materials. 12mm segment height.

Product code	Barcode	Diameter (in)	Bore (mm)	RPM	Inner Qty	Outer Qty
OX-04MPS	9341231002335	4	16	14500	6	24
OX-45MPS	9341231002342	4 1/2	22.2/20	13200	6	24
OX-05MPS	9341231002359	5	22.2/20	12000	6	24
OX-06MPS	9341231002366	6	25.4/20	10200	3	6
OX-07MPS	9341231002373	7	25.4/22.2	8500	4	12
OX-08MPS	9341231002380	8	30/25.4	7600	3	6
OX-09MPS	9341231002397	9	25.4/22.2	6600	6	24
OX-10MPS	9341231006279	10	25.4/20	6100	3	6
OX-14MPS	9341231002410	14	25.4/20	5400	5	10



CUTS EVERYTHING ON A CONSTRUCTION SITE!

PRO MPSS SUPERFAST UNIVERSAL/HARD

Guaranteed to cut all masonry construction products. Excellent fast cut universal & hard materials. Reinforced flange. Cooling holes. Semi-transparent. Applications include: granite, natural stone, clay products, engineering bricks, concrete products, all building materials. Wear will increase on abrasive materials. 15mm segment height. Not recommended for reinforced concrete - use MPS blade.

Product code	Barcode	Diameter (in)	Bore (mm)	RPM	Inner Qty	Outer Qty
OX-12MPSS	9341231003172	12	25.4/20	5400	3	5
OX-14MPSS	9341231003189	14	25.4/20	4300	5	10
OX-16MPSS	9328217012502	16	25.4/20	3800	5	10



PRO LCO CYCLONE CONCRETE

Durable 'Cuts it all' general purpose and concrete products blade with 10mm segment height. Applications include: cured reinforced concrete, concrete kerbs and slabs, concrete pavers, roof tiles, bricks, general building materials.

Product code	Barcode	Diameter (in)	Bore (mm)	RPM	Inner Qty	Outer Qty
OX-LCO-14	9341231002519	14	25.4/20	4300	5	10
OX-LCO-16	9341231020353	16	25.4/20	3800	5	10
OX-LCO-20	9341231037597	20	25.4/20	3000	2	4



PRO PB10 ZEBRA ABRASIVE/GENERAL PURPOSE

High performance dual purpose blade with 10mm segment height. Features drop segment to prevent undercut. Applications include: abrasive building materials, concrete products, roof tiles, blocks, floorsaw concrete & dual concrete/asphalt.

Product code	Barcode	Diameter (in)	Bore (mm)	RPM	Inner Qty	Outer Qty
OX-PB10-4	9341231002533	4	16	14500	6	24
OX-PB10-4.5	9341231002540	4 1/2	22.2/20	13200	6	24
OX-PB10-5	9341231002557	5	22.2/20	12000	6	24
OX-PB10-9	9341231002595	9	25.4/22.2	6600	6	24
OX-PB10-14	9341231002618	14	25.4/20	4300	5	10
OX-PB10-16	9341231020360	16	25.4/20	3800	5	10



PRO PA10 SHARK ASPHALT

Undercut protected blade with 10mm segment height. Applications include: asphalt and extremely abrasive products.

Product code	Barcode	Diameter (in)	Bore (mm)	RPM	Inner Qty	Outer Qty
OX-PA10-14	9341231002649	14	25.4/20	4300	5	10
OX-PA10-16	9341231002656	16	25.4/20	3800	5	10





Angle Grinders & Demolition Saws



ULTIMATE UC10 CYCLONE CONCRETE PRODUCTS

Blade with 10mm segment height. Featuring tear drop gullet design, cooling holes, reinforced centre flange. Applications include: in-situ concrete (including reinforced), concrete products, natural stone, building materials. Ideal 'civils' blade.

Product code	Barcode	Diameter (in)	Bore (mm)	RPM	Inner Qty	Outer Qty
OX-UC10-4	9341231002762	4	16	14500	6	24
OX-UC10-4.5	9341231002779	4 ½	22.2/20	13200	6	24
OX-UC10-5	9341231002786	5	22.2/20	12000	6	24
OX-UC10-7	9341231002809	7	25.4/22.2	8500	4	12
OX-UC10-8	9341231002816	8	30/25.4	7600	3	6
OX-UC10-9	9341231002823	9	25.4/22.2	6600	6	24
OX-UC10-14	9341231002847	14	25.4/20	5400	5	10
OX-UC10-16	9341231002854	16	25.4/20	4800	5	10



ULTIMATE UB10 ZEBRA ABRASIVE

Dual purpose blade with 10mm segment height. Featuring 'wedge segment' undercut protection, narrow gullet. Applications include: dual purpose concrete & asphalt, sandstone, abrasive materials and abrasive concrete products (e.g. roof tiles, blocks).

Product code	Barcode	Diameter (in)	Bore (mm)	RPM	Inner Qty	Outer Qty
OX-UB10-4.5	9341231002878	4 ½	22.2/20	13200	6	24
OX-UB10-5	9341231002885	5	22.2/20	12000	6	24
OX-UB10-6	9341231002892	6	25.4/20	10200	3	6
OX-UB10-7	9341231002908	7	25.4/22.2	8500	4	12
OX-UB10-8	9341231002915	8	30/25.4	7600	3	6
OX-UB10-9	9341231002922	9	25.4/22.2	6600	6	24
OX-UB10-14	9341231002946	14	25.4/20	5400	5	10
OX-UB10-16	9341231002953	16	25.4/20	4800	5	10



ULTIMATE UA10 BLACK SHARK ASPHALT

Asphalt blade with 10mm segment height. Featuring 'wedge segment' undercut protection, 'U' clearance gullet. Applications include: asphalt & extremely abrasive products, cement screed, lignacite blocks.

Product code	Barcode	Diameter (in)	Bore (mm)	RPM	Inner Qty	Outer Qty
OX-UA10-14	9341231002977	14	25.4/20	5400	5	10
OX-UA10-16	9341231002984	16	25.4/20	4800	5	10



Bricksaw & Blocksaw Blades

Material Classes

U CLASS UNIVERSAL HARD

Concrete pavers
Clay products
Granite
Engineering bricks
Hard bricks

H CLASS HARD BRICK

Medium to hard
Clay bricks and pavers

C CLASS COMBINATION

Clay bricks
Clay pavers
Concrete pavers

S CLASS SOFT BRICK

Concrete pavers
Besser blocks
Sandstone
Pavers Lignacite blocks

QUALITY: **TRADE SERIES**

prefix: T



THB



TCB



TSB

QUALITY: **PRO SERIES**

prefix: P

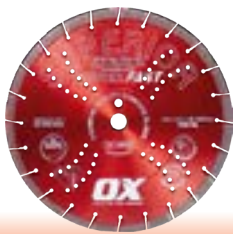

MPSS



PHB



PCB



PSB

QUALITY: **SILENTYPE SERIES**

prefix: P



PHBS



PCBS



PSBS

Logical separation of each different diamond blade into different material classes

Very clear quality bands



Bricksaw & Blocksaw Blades



TRADE THB HARD BRICK

The hard brick blade with sintered segment.
Applications include: medium to hard clay bricks and pavers.

Product code	Barcode	Diameter (in)	Bore (mm)	RPM	Inner Qty	Outer Qty
OX-THB-12	9341231003042	12	25.4/20	5400	3	5
OX-THB-14	9341231003059	14	25.4/20	4300	5	10
OX-THB-16	9341231003066	16	25.4/20	3800	5	10



TRADE TCB 50 / 50 COMBINATION

The combination blade with sintered segment.
Applications include: 50/50 clay/concrete, clay bricks and pavers.

Product code	Barcode	Diameter (in)	Bore (mm)	RPM	Inner Qty	Outer Qty
OX-TCB-12	9341231003073	12	25.4/20	5400	2	5
OX-TCB-14	9341231003080	14	25.4/20	4300	5	10
OX-TCB-16	9341231003097	16	25.4/20	3800	5	10



TRADE TSB SOFT BRICK

The soft brick/block blade for abrasive materials. Sintered welded segment.
Applications include: concrete, pavers, besser blocks and sandstone.

Product code	Barcode	Diameter (in)	Bore (mm)	RPM	Inner Qty	Outer Qty
OX-TSB-12	9341231003127	12	25.4/20	5400	3	5
OX-TSB-14	9341231003134	14	25.4/20	4300	5	10
OX-TSB-16	9341231003141	16	25.4/20	3800	5	10



PRO MPSS UNIVERSAL

Guaranteed to cut all construction products. 15mm segment height. Excellent fast cut universal & hard materials. Reinforced flange. Cooling holes. Semi-transparent. Applications include: granite, natural stone, clay products, engineering bricks, concrete pavers and hard bricks. Wear will increase on abrasive materials. Ideal for travertine.

Product code	Barcode	Diameter (in)	Bore (mm)	RPM	Inner Qty	Outer Qty
OX-12MPSS	9341231003172	12	25.4/20	5400	3	5
OX-14MPSS	9341231003189	14	25.4/20	4300	5	10
OX-16MPSS	9328217012502	16	25.4/20	3800	5	10

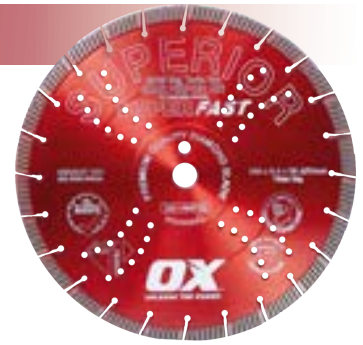

PRO PHB HARD BRICK

The hard brick blade with laser welded segments. Applications include: medium to hard clay bricks and pavers.

Product code	Barcode	Diameter (in)	Bore (mm)	RPM	Inner Qty	Outer Qty
OX-PHB-14	9341231003233	14	25.4/20	4300	5	10
OX-PHB-16	9341231003240	16	25.4/20	3800	5	10



PRO PCB 50 / 50 COMBINATION

The combination blade with laser welded segment. Applications include: 50/50 clay/concrete, clay bricks and pavers.

Product code	Barcode	Diameter (in)	Bore (mm)	RPM	Inner Qty	Outer Qty
OX-PCB-14	9341231003264	14	25.4/20	4300	5	10
OX-PCB-16	9341231003271	16	25.4/20	3800	5	10



PRO PSB SOFT BRICK

The soft brick/block blade for abrasive materials. Applications include: concrete pavers and besser blocks.

Product code	Barcode	Diameter (in)	Bore (mm)	RPM	Inner Qty	Outer Qty
OX-PSB-12	9341231003301	12	25.4/20	5400	3	5
OX-PSB-14	9341231003318	14	25.4/20	4300	5	10
OX-PSB-16	9341231003325	16	25.4/20	3800	5	10





Bricksaw & Blocksaw Blades - Silent



PRO PHBS HARD BRICK SILENTYPE

Laminated core for noise reduction. The hard brick blade with laser welded segments. Applications include: medium to hard clay bricks and pavers.

Product code	Barcode	Diameter (in)	Bore (mm)	RPM	Inner Qty	Outer Qty
OX-PHBS-12	9341231003356	12	25.4/20	5400	3	5
OX-PHBS-14	9341231003363	14	25.4/20	4300	5	10
OX-PHBS-16	9341231003370	16	25.4/20	3800	5	10



PRO PCBS 50 / 50 COMBINATION SILENTYPE

Laminated core for noise reduction. The combination blade with laser welded segment. Applications include: 50/50 clay/concrete, clay bricks and pavers.

Product code	Barcode	Diameter (in)	Bore (mm)	RPM	Inner Qty	Outer Qty
OX-PCBS-12	9341231003387	12	25.4/20	5400	3	5
OX-PCBS-14	9341231003394	14	25.4/20	4300	5	10
OX-PCBS-16	9341231003400	16	25.4/20	3800	5	10
OX-PCBS-18	9341231003417	18	25.4/20	3350	2	4
OX-PCBS-20	9341231003424	20	25.4/20	3050	2	4



PRO PSBS SOFT BRICK SILENTYPE

Laminated core for noise reduction. The soft brick/block blade for abrasive materials. Applications include: concrete pavers and besser blocks.

Product code	Barcode	Diameter (in)	Bore (mm)	RPM	Inner Qty	Outer Qty
OX-PSBS-12	9341231003431	12	25.4/20	5400	3	5
OX-PSBS-14	9341231003448	14	25.4/20	4300	5	10
OX-PSBS-16	9341231003455	16	25.4/20	3800	5	10
OX-PSBS-18	9341231003462	18	25.4/20	3350	2	4
OX-PSBS-20	9341231003479	20	25.4/20	3050	2	4



Floorsaw Blades

Material Classes		
C CLASS CONCRETE/ GENERAL PURPOSE Concrete & concrete products General purpose Unabrasive products Building products	B CLASS ABRASIVE/ GENERAL PURPOSE Abrasive materials Concrete & asphalt Dual purpose Concrete products Concrete roof tiles	A CLASS ASPHALT Asphalt & extremely abrasive products Cement screed Lignacite blocks

QUALITY: **PRO SERIES** prefix: P



PSF

QUALITY: **ULTIMATE SERIES** prefix: U



UCF UBF UAF

Logical separation of each different diamond blade into different material classes

Very clear quality bands



Floorsaw Blades



PRO PSF GREEN CONCRETE & ASPHALT OVER CONCRETE

Specialist blade with 10mm segment height. Featuring 'wedge segment' undercut protection and narrow slot. Applications include: green concrete, asphalt over concrete, dual concrete and asphalt, abrasive materials.

Product code	Barcode	Diameter (in)	Bore (mm)	RPM	Inner Qty	Outer Qty
OX-PSF-16	9341231003943	16	25.4/20	4800	5	10
OX-PSF-18	9341231003950	18	25.4/20	3400	2	4
OX-PSF-20	9341231003967	20	25.4/20	3000	2	4
OX-PSF-24	9341231003974	24	25.4/20	2500	2	4



ULTIMATE UCF CONCRETE

Extremely high quality blade with 10mm segment height. Used by professionals. Applications include: in-situ concrete - flint and limestone aggregate, reinforced concrete.

Product code	Barcode	Diameter (in)	Bore (mm)	RPM	Inner Qty	Outer Qty
OX-UCF-18	9341231003837	18	25.4/20	2700	2	4
OX-UCF-20	9341231003844	20	25.4/20	2450	2	4



ULTIMATE UBF DUAL PURPOSE

Dual purpose blade with 10mm segment height. Featuring 'wedge segment' undercut protection, narrow gullet. Applications include: concrete and asphalt, abrasive concrete, asphalt over concrete, concrete pavers.

Product code	Barcode	Diameter (in)	Bore (mm)	RPM	Inner Qty	Outer Qty
OX-UBF-18	9341231003875	18	25.4/20	3400	2	4
OX-UBF-20	9341231003882	20	25.4/20	3000	2	4
OX-UBF-24	9341231003899	24	25.4/20	2500	2	4



























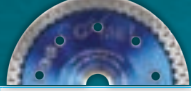

ULTIMATE UAF ASPHALT

Asphalt blade with 10mm segment height. Featuring 'wedge segment' undercut protection, 'U' clearance gullet. Applications include: hot rolled and footway asphalt, cement screed, extremely abrasive new green concrete.

Product code	Barcode	Diameter (in)	Bore (mm)	RPM	Inner Qty	Outer Qty
OX-UAF-18	9341231003912	18	25.4/20	3400	2	4
OX-UAF-20	9341231003929	20	25.4/20	3000	2	4
OX-UAF-24	9341231003936	24	25.4/20	2500	2	4



Ceramic & Stone Tiling Blades

APPLICATION GUIDE	CERAMIC TILES	NATURAL STONE	GRANITE	MARBLE	PORCELAIN	
TRADE SERIES OX-TCT 						
ULTIMATE SERIES OX-UCT 						
ULTIMATE SERIES OX-UCFT 						
ULTIMATE SERIES OX-UCFM 						
LEGEND		Will Cut Well		Will Not Cut		Will Cut

TRADE TCT CERAMICS

Continuous rim diamond blade for cutting ceramic tiles. Popular sizes. Applications include: ceramic tiles.

Product code	Barcode	Diameter (in)	Bore (mm)	RPM	Inner Qty	Outer Qty
OX-TCT-4	9341231004070	4	16	14500	6	24
OX-TCT-4.5	9341231004087	4 1/2	22.2/20	13200	6	24
OX-TCT-5	9341231004094	5	22.2/20	12000	6	24
OX-TCT-7	9341231004117	7	25.4/22.2	8500	4	12
OX-TCT-9	9341231004131	9	30/25.4	6600	6	24
OX-TCT-10	9341231004148	10	30/25.4	6100	2	6
OX-TCT-12	9341231004155	12	30/25.4	5400	2	5
OX-TCT-14	9341231004162	14	30/25.4	4300	5	10



ULTIMATE UCT CERAMICS

Featuring 10mm continuous rim, fine cut, high concentration, s-slot cool cutting, s-denso silencing. Cuts all tiles – guaranteed! Applications include: ceramic tiles, natural stone, porcelain, granite, marble.

Product code	Barcode	Diameter (in)	Bore (mm)	RPM	Inner Qty	Outer Qty
OX-UCT-4	9341231004278	4	16	14500	6	24
OX-UCT-4.5	9341231004285	4 1/2	22.2/20	13200	6	24
OX-UCT-5	9341231004292	5	22.2/20	12000	6	24
OX-UCT-6	9341231004308	6	25.4/22.2	10200	3	6
OX-UCT-7	9341231004315	7	25.4/22.2	8500	4	12
OX-UCT-8	9341231004322	8	30/25.4	7600	3	6
OX-UCT-9	9341231004339	9	30/25.4	6600	6	24
OX-UCT-10	9341231004346	10	30/25.4	6100	3	6
OX-UCT-12	9341231004353	12	30/25.4	5400	3	5
OX-UCT-14	9341231004360	14	30/25.4	4300	5	10





Ceramic & Stone Tiling Blades

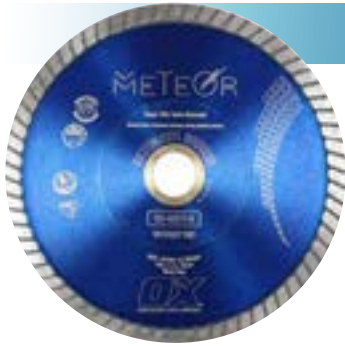

ULTIMATE UCFT FINE TURBO PORCELAIN

Super thin turbo with 7mm segment height. The finest cut for porcelain. Applications include: porcelain, ceramic, natural stone, granite. 1.2mm Blade Thickness.

Product code	Barcode	Diameter (in)	Bore (mm)	RPM	Inner Qty	Outer Qty
OX-UCFT-4	9341231015441	4	16	19, 100	6	24
OX-UCFT-4.5	9341231015458	4 ½	16	16, 650	6	24
OX-UCFT-5	9341231015465	5	16	15, 300	6	24

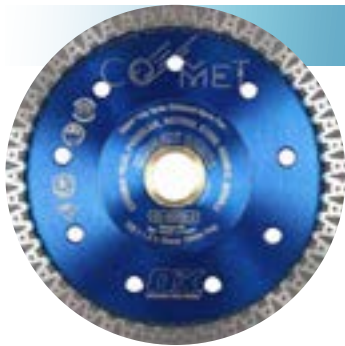

ULTIMATE UCFM FINE MESH PORCELAIN

Super thin turbo with 10mm segment height. The finest cut for porcelain. Applications include: porcelain, ceramic, natural stone, granite. 1.2mm Blade thickness.

Product code	Barcode	Diameter (in)	Bore (mm)	RPM	Inner Qty	Outer Qty
OX-UCFM-4	9341231015472	4	16	19, 100	6	24
OX-UCFM-4.5	9341231015489	4 ½	16	16, 650	6	24
OX-UCFM-5	9341231015496	5	16	15, 300	6	24



Tuck Pointing/Mortar Raking Blades

Tuck pointing diamond blades provide fast, effective removal of mortar joints prior to re-pointing. With a segment width of 6mm, OX mortar rakes are designed to cope with removal of most joint widths.

A thicker centre plate maintains a stable and durable cut and protects against undercutting.

The market leading PMR is now also available in 7" (180mm) for use on 7" and 9" angle grinders, offering more powerful cutting and greater cutting depth. The PMR puts less strain on a 9" angle grinder and is safer and more manageable than using a 9" (230mm) diameter blade in 6mm segment width.

PRO PMR TUCK POINTING





High quality 6mm wide segment blade. The market leader – a great product to use. Fast cut/long life. Applications include: mortar raking, abrasive materials.

Product code	Barcode	Diameter (in)	Bore (mm)	RPM	Inner Qty	Outer Qty
OX-PMR-4	9341231031519	4	16	-	3	6
OX-PMR-4.5	9341231014628	4 ½	22.2/20	-	3	6
OX-PMR-5	9341231004025	5	22.2/20	-	3	6
OX-PMR-7	9341231004032	7	22.2/20	-	3	6





Diamond Cup Wheels

APPLICATION GUIDE			
PRO SERIES OX-PCT 	ULTIMATE SERIES OX-UCD 	ULTIMATE SERIES OX-UCRB 	ULTIMATE SERIES OX-UCG 
<p>High quality blade with 10mm segment height. Used by professionals. Applications include: in-situ concrete-flint and limestone aggregate, reinforced concrete.</p>	<p>Professional double row cup grinder for universal concrete, construction products and stone. Long life. Applications include: concrete, natural stone and construction products.</p>	<p>High quality, fast stripping radial segment cup wheel. Available with various number of segments in radial pattern. Applications include: fast stripping of concrete coatings such as epoxy, paint, and glues. Can also be used for concrete removal and formwork cleaning.</p>	<p>Extremely versatile wide turbo designed for use with Makita PC1100. Fast cutting, long life. Applications include: concrete and natural stone.</p>

Precision manufactured diamond grinding cups and heads for angle grinders and concrete planers.

We also provide a range of specialist and bespoke grinding heads and tools for a variety of machines and applications.

Available in either 14mm thread or a 22.2mm bush.



PRO PCT TURBO CUP WHEEL

High quality blade with 10mm segment height. Used by professionals. Applications include: in-situ concrete - flint and limestone aggregate, reinforced concrete.

Product code	Barcode	Diameter (in)	Bore (mm)	Grit	Inner Qty	Outer Qty
OX-PCTT-4	9341231004865	4	M14	30	3	6
OX-PCTB-4	9341231004872	4	22.2	30	3	6
OX-PCTT-5	9341231004889	5	M14	30	3	6
OX-PCTB-5	9341231004896	5	22.2	30	3	6
OX-PCTT-7	9341231004902	7	M14	30	3	6
OX-PCTB-7	9341231004919	7	22.2	30	3	6



ULTIMATE UCD DOUBLE ROW CUP WHEEL

Professional double row cup grinder for universal concrete, construction products and stone. Long life. Applications include: concrete, natural stone and construction products.

Product code	Barcode	Diameter (in)	Bore (mm)	Grit	Inner Qty	Outer Qty
OX-UCDT-4	9341231004926	4	M14	30	3	6
OX-UCDB-4	9341231004933	4	22.2	30	3	6
OX-UCDT-4.5	9341231004940	4 ½	M14	30	3	6
OX-UCDB-4.5	9341231004957	4 ½	22.2	30	3	6
OX-UCDT-5	9341231004964	5	M14	30	3	6
OX-UCDB-5	9341231004971	5	22.2	30	3	6
OX-UCDT-6	9341231004988	6	M14	30	3	6
OX-UCDB-6	9341231004995	6	22.2	30	3	6
OX-UCDT-7	9341231005008	7	M14	30	3	6
OX-UCDB-7	9341231005015	7	22.2	30	3	6



ULTIMATE UCRB RADIAL SEGMENT GRINDING CUP WHEEL

High quality, fast stripping radial segment cup wheel. Available with various number of segments in radial pattern. Applications include: fast stripping of concrete coatings such as epoxy, paint, and glues. Can also be used for concrete removal and formwork cleaning.



New

Product code	Barcode	Diameter (in)	Bore (mm)	No of Segments	Inner Qty	Outer Qty
OX-UCRB-4/8	9341231016387	4	22.2	8	6	36
OX-UCRB-5/10	9341231016400	5	22.2	10	6	36
OX-UCRB-5/6	9341231016394	5	22.2	6	6	36
OX-UCRB-7/12	9341231016417	7	22.2	12	6	12
OX-UCRB-7/18	9341231016424	7	22.2	18	6	12

ULTIMATE UCG TURBO CUP WHEEL

Extremely versatile wide turbo designed for use with Makita PC1100. Fast cutting, long life. Applications include: concrete and natural stone.



FINE GRIT

Product code	Barcode	Diameter (in)	Bore (mm)	Grit	Inner Qty	Outer Qty
OX-UCGFT-4	9341231038112	4	M14	120	3	6
OX-UCGFB-4	9341231038082	4	22.2	120	3	6
OX-UCGFT-5	9341231038129	5	M14	120	3	6
OX-UCGFB-5	9341231038099	5	22.2	120	3	6
OX-UCGFT-7	9341231038136	7	M14	120	3	6
OX-UCGFB-7	9341231038105	7	22.2	120	3	6

MEDIUM GRIT

Product code	Barcode	Diameter (in)	Bore (mm)	Grit	Inner Qty	Outer Qty
OX-UCGMT-4	9341231038174	4	M14	60	3	6
OX-UCGMB-4	9341231038143	4	22.2	60	3	6
OX-UCGMT-5	9341231038181	5	M14	60	3	6
OX-UCGMB-5	9341231038150	5	22.2	60	3	6
OX-UCGMT-7	9341231038198	7	M14	60	3	6
OX-UCGMB-7	9341231038167	7	22.2	60	3	6

COARSE GRIT

Product code	Barcode	Diameter (in)	Bore (mm)	Grit	Inner Qty	Outer Qty
OX-UCGT-4	9341231005022	4	M14	30	3	6
OX-UCGB-4	9341231005039	4	22.2	30	3	6
OX-UCGT-4.5	9341231005046	4 ½	M14	30	3	6
OX-UCGB-4.5	9341231005053	4 ½	22.2	30	3	6
OX-UCGT-5	9341231005060	5	M14	30	3	6
OX-UCGB-5	9341231005077	5	22.2	30	3	6
OX-UCGT-7	9341231005084	7	M14	30	3	6
OX-UCGB-7	9341231005091	7	22.2	30	3	6



Specialist Blades

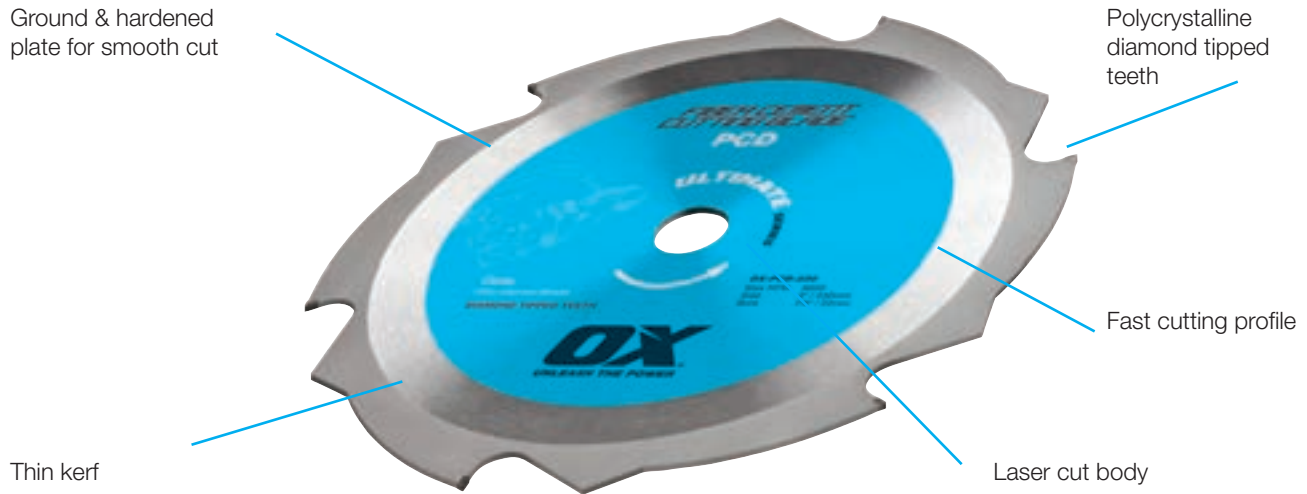

ULTIMATE PCD FIBRE CEMENT BLADE



Other features include:

- Thin kerf blade for minimal dust
- Ground hardened plate for smooth cut
- Cuts up to 9,000 feet of fibre cement
- Polycrystalline diamond tipped teeth
- Laser cut body, stronger tooth attachment and greater accuracy

Product code	Barcode	Diameter (in)	Bore (mm)	RPM	Inner Qty	Outer Qty
OX-PCD-185	9341231035432	7" 4 Teeth	185	30	4	12
OX-PCD-230	9341231035449	9" 6 Teeth	230	22.2	4	12

PRO PMT ELECTROPLATED MARBLE



Electroplated diamond blade for fine cutting of marble and glass reinforced plastic. Applications include: marble, fibreglass, plastic and glass reinforced plastic.

Product code	Barcode	Diameter (in)	Bore (mm)	RPM	Inner Qty	Outer Qty
OX-PMT-4	9341231004476	4	16	15180	6	12
OX-PMT-5	9341231004490	5	22.2/20	12144	6	12



Diamond Core Drills

With a wealth of experience in all types of diamond core drilling, OX has the most complete range of products available in the market today.

NO.1 FOR DRY CORE DRILLING

OX: the home of dry core drills.

INDUSTRY BENCHMARK

The most popular.

For drilling brick and block.

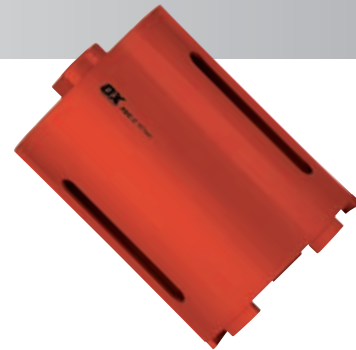

NO.1 FOR WET CORE DRILLING

The professional choice for the professional contractor. UWC wet concrete drills have been tested and proven in the most demanding aggregates in the world.

For drilling reinforced concrete.



NO.1 FOR TILE DRILLING

PDD Tile Drilling revolution. Quite simply, exactly what the market has been asking for. Fast, easy to use, and completely trouble free.



With the TTD cores for occasional users, and a choice of the PDD or UTDH cores for professional users – OX have the answers.

For drilling porcelain, granite, hard natural stones and ceramics.



NO.1 FOR CORE DRILLING KITS

The perfect start to dry core drilling, our aluminium cases are sturdier, smarter and contain more accessories than the competition. Often copied, but never surpassed, these are the cores to be seen with – and use.





Dry Core Drills

Core diameter visually shown

Precision engineering

Slotted core design: efficient dust clearance and core removal

Rapid, clean cutting; long life.

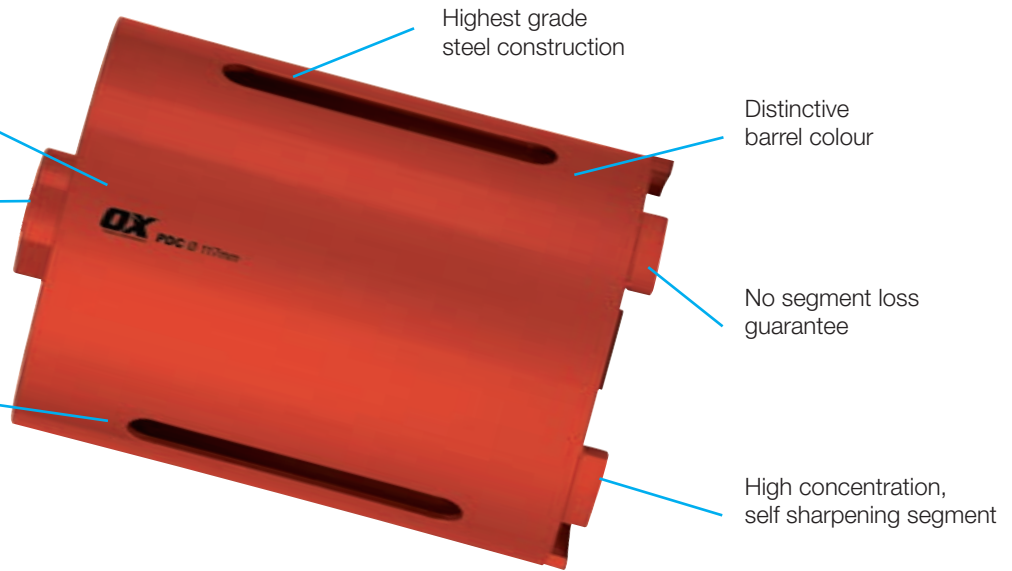

Highest grade steel construction

Distinctive barrel colour

No segment loss guarantee

High concentration, self sharpening segment

PRO PDC DRY CORE DRILL

Universal dry diamond core drill in all popular plumbers sizes up to 127mm. Slotted barrel provides efficient dust clearance and ease of removing drilled core. For brick and blockwork. Applications include: medium and soft bricks, concrete blocks (lightweight and dense), abrasive concrete products. Occasional use in harder materials e.g. semi engineering bricks and clay products. Minimum drill size: 850W



Product code	Barcode	Diameter (mm)	Length (mm)	Back end	Inner Qty	Outer Qty
OX-PDC-028	9341231005183	28	300	1/2" BSP	3	6
OX-PDC-032	9341231005190	32	150	1/2" BSP	3	6
OX-PDC-038	9341231005206	38	150	1/2" BSP	3	6
OX-PDC-048	9341231005213	48	150	1/2" BSP	3	6
OX-PDC-052	9341231005220	52	150	1/2" BSP	3	6
OX-PDC-065	9341231005237	65	150	1/2" BSP	2	4
OX-PDC-078	9341231005244	78	150	1/2" BSP	2	4
OX-PDC-091	9341231005251	91	150	1/2" BSP	2	4
OX-PDC-102	9341231005268	102	150	1/2" BSP	2	4
OX-PDC-107	9341231005275	107	150	1/2" BSP	2	4
OX-PDC-117	9341231005282	117	150	1/2" BSP	2	4
OX-PDC-127	9341231005299	127	150	1/2" BSP	2	4

PRO PCC DRY CORE CASE



FEATURES

- Everything you need to get started with dry core drilling in a sturdy aluminium case
- Contains PDC cores – 38, 52, 65, 117, 127mm
- Contains HEX & SDS adapters and extensions

Product code	Barcode	Core Sizes (mm)	Inner Qty	Outer Qty
OX-PCC-5	9341231007309	38, 52, 65, 117, 127	2	4



ULTIMATE UCC HELIX DRY CORE CASE

FEATURES

- Everything you need to get started with dry core drilling in a sturdy aluminium case
- Contains UDCL LONG LIFE cores – 38, 52, 65, 117, 127mm
- Contains HEX & SDS adapters and extensions



Product code	Barcode	Core Sizes (mm)	Inner Qty	Outer Qty
OX-UCC-5	9341231036491	38, 52, 65, 117, 127	2	4

Dry Core Accessories

OX dry core accessories are manufactured from the highest grade steel to ensure that they can withstand the toughest use. Zinc plating enhances the visual appearance and protects against rust without leaving oil deposits. The most complete range of accessories to cover all machinery options and personal preferences.

ADAPTORS - BSP (M)

Product code	Barcode	Core Sizes (mm)	Inner Qty	Outer Qty
OX-JX01	9341231012518	HEX ADAPTOR ONLY	3	6
OX-JX31	9341231012525	HEX 10" LONG ADAPTOR	3	6
OX-JS01	9341231012532	SDS (PLUS) ADAPTOR ONLY	3	6
OX-JS25	9341231012549	SDS (PLUS) 10" LONG ADAPTOR	3	6
OX-JM01	9341231012556	SDS MAX ADAPTOR ONLY	3	6
OX-JBA12	9341231012563	1/2" X 20 UN(F)-1/2" BSP(M) ADAPTOR	3	6
OX-JBA18	9341231012570	M18 X 2.5 (F) TO 1/2" BSP (M) ADAPTOR	3	6
OX-JBA58	9341231012587	1/2" X 16UN(F) TO 1/2" BSP(M) ADAPTOR	3	6



PILOTS & DRIFTS

Product code	Barcode	Core Sizes (mm)	Inner Qty	Outer Qty
OX-JB09	9341231012648	1/2" GUIDE ROD 8-1/4"	3	6
OX-JB13	9341231012655	1/2" A TAPER DRILL 8-1/4"	3	6
OX-JB05	9341231012662	DRIFT KEY	3	6



EXTENSIONS

Product code	Barcode	Core Sizes (mm)	Inner Qty	Outer Qty
OX-JB26	9341231012693	1/2" BSP 10" SOLID EXTENSION + A TAPER	3	6
OX-JB25	9341231012709	1/2" BSP 10" HOLLOW EXTENSION	3	6
OX-JX15	9341231012716	HEX 6" EXTENSION (C/W ALLEN KEY)	3	6



ADAPTOR PACKS

Product code	Barcode	Core Sizes (mm)	Inner Qty	Outer Qty
OX-JX03	9341231012594	HEX ADAPTOR PACK (JX01, JB09, JB05)	3	6
OX-JX03-13	9341231012600	HEX A TAPER DRILL ADAPTOR PACK (JX01, JB13, JB05)	3	6
OX-JS03	9341231012617	SDS ADAPTOR PACK (JS01, JB09, JB05)	3	6
OX-JS03-13	9341231012624	SDS A TAPER DRILL ADAPTOR PACK (JS01, JB13, JB05)	3	6
OX-JM03	9341231012631	SDS MAX ADAPTOR PACK (JM01, JB09, JB05)	3	6





Wet Core Drills

ULTIMATE UWC 1-1/4" UNC WET CORE

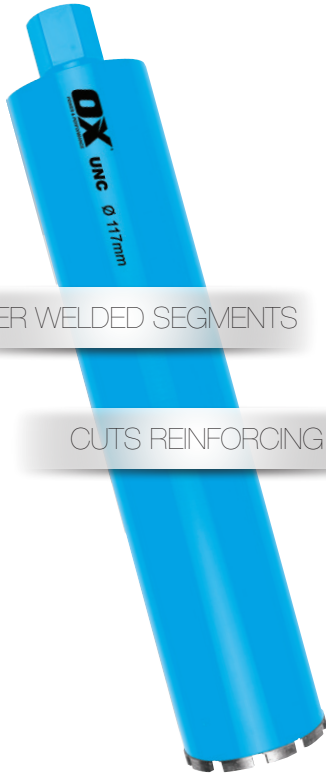

ULTIMATE wet diamond core drill for professional rig mounted use. 450mm drilling length. 10mm segment height. Applications include: flint and limestone aggregate concrete; light to medium reinforced concrete; universal building products.

Product code	Barcode	Diameter (mm)	Length (mm)	Back end	3Inner Qty	Outer Qty
OX-UWC022-450	9341231005787	22	450	1 1/4" UNC	3	6
OX-UWC025-450	9341231005794	25	450	1 1/4" UNC	3	6
OX-UWC028-450	9341231005800	28	450	1 1/4" UNC	3	6
OX-UWC032-450	9341231005824	32	450	1 1/4" UNC	3	6
OX-UWC036-450	9341231005831	36	450	1 1/4" UNC	3	6
OX-UWC052-450	9341231005879	52	450	1 1/4" UNC	2	4
OX-UWC056-450	9341231005886	56	450	1 1/4" UNC	2	4
OX-UWC062-450	9341231005893	62	450	1 1/4" UNC	2	4
OX-UWC065-450	9341231005909	65	450	1 1/4" UNC	2	4
OX-UWC072-450	9341231005916	72	450	1 1/4" UNC	2	4
OX-UWC076-450	9341231005923	76	450	1 1/4" UNC	2	4
OX-UWC082-450	9341231005930	82	450	1 1/4" UNC	2	4
OX-UWC087-450	9341231005947	87	450	1 1/4" UNC	2	4
OX-UWC092-450	9341231005954	92	450	1 1/4" UNC	2	4
OX-UWC102-450	9341231005961	102	450	1 1/4" UNC	2	4
OX-UWC112-450	9341231005985	112	450	1 1/4" UNC	2	4
OX-UWC117-450	9341231005992	117	450	1 1/4" UNC	2	4
OX-UWC122-450	9341231006005	122	450	1 1/4" UNC	2	4
OX-UWC127-450	9341231006012	127	450	1 1/4" UNC	2	4
OX-UWC152-450	9341231006043	152	450	1 1/4" UNC	2	4
OX-UWC162-450	9341231006050	162	450	1 1/4" UNC	2	4
OX-UWC172-450	9341231006067	172	450	1 1/4" UNC	2	4
OX-UWC200-450	9341231006081	200	450	1 1/4" UNC	2	4

ULTIMATE WET CORE ACCESSORIES



Tough, durable adaptors and extensions for wet core drilling.

Product code	Barcode	Description	Inner Qty	Outer Qty
OX-JN55	9341231011771	1/2" BSP(M) - 1/2" BSP(M) ADAPTOR	3	6
OX-JN56	9341231011788	1/2" BSP(F) - 1/2" BSP(F) ADAPTOR	3	6
OX-JN65	9341231011795	1/2" BSP(M) - 1 1/4" UNC(M) ADAPTOR	3	6
OX-JN66	9341231011801	1/2" BSP(F) - 1 1/4" UNC(F) ADAPTOR	3	6
OX-JNHAD3	9341231011818	1/2" BSP(F) - HILTI DD100/130 ADAPTOR	3	6
OX-JN25	9341231011825	1/2" BSP 250mm HOLLOW EXTENSION	3	6
OX-JN20	9341231011832	1 1/4" UNC 200mm HOLLOW EXTENSION	3	6
OX-JN30	9341231011749	1 1/4" UNC 300mm HOLLOW EXTENSION	3	6



Tile Drills

TRADE TTD DIAMOND HOLESAW

Fast, fine cutting of marble, ceramics and stone. Low cost for the occasional user. Straight shank for use in 3 jaw chucks. Recommended for use with water feed.



Product code	Barcode	Diameter (mm)	Inner Qty	Outer Qty
OX-TTD-06	9341231006319	6	3	6
OX-TTD-08	9341231006326	8	3	6
OX-TTD-10	9341231006333	10	3	6
OX-TTD-13	9341231006340	13	3	6
OX-TTD-20	9341231006364	20	3	6
OX-TTD-25	9341231016371	25	3	6
OX-TTD-30	9341231006395	30	3	6
OX-TTD-32	9341231006401	32	3	6
OX-TTD-36	9341231006418	36	3	6
OX-TTD-45	9341231016432	45	3	6
OX-TTD-51	9341231016449	51	3	4
OX-TTD-54	9341231016456	54	3	4
OX-TTD-63	9341231016463	63	3	4

ULTIMATE JP WATER SWIVEL

Holesaw accessory options for accurate positioning and water cooling.

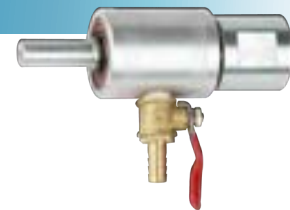

Product code	Barcode	Description	Inner Qty	Outer Qty
JP35	9341231036194	1/2" BSP(F) - Straight Shank Water Swivel	3	6

ULTIMATE UTDH WET DIAMOND HOLESAW - HEX SHANK



Product code	Barcode	Diameter (mm)	Length (mm)	Shank (mm)	Inner Qty	Outer Qty
OX-UTDH-06	9341231020797	6	40	10	3	6
OX-UTDH-08	9341231020803	8	40	10	3	6
OX-UTDH-10	9341231020810	10	40	10	3	6
OX-UTDH-12	9341231020827	12	40	12	3	6
OX-UTDH-16	9341231020834	16	40	12	3	6
OX-UTDH-20	9341231020841	20	40	12	3	6
OX-UTDH-22	9341231020858	22	40	12	3	6
OX-UTDH-25	9341231020865	25	40	12	3	6
OX-UTDH-28	9341231020872	28	40	12	3	6
OX-UTDH-30	9341231020889	30	40	12	3	6
OX-UTDH-32	9341231020896	32	40	12	3	6
OX-UTDH-36	9341231020902	36	40	12	3	6
OX-UTDH-40	9341231020912	40	40	12	3	6
OX-UTDH-45	9341231020926	45	40	12	3	6
OX-UTDH-52	9341231020933	52	40	12	3	6
OX-UTDH-56	9341231020940	56	40	12	3	6
OX-UTDH-62	9341231020957	62	40	12	3	6
OX-UTDH-65	9341231020964	65	40	12	3	6
OX-UTDH-72	9341231020971	70	40	12	3	6
OX-UTDH-76	9341231020988	76	40	12	3	6
OX-UTDH-82	9341231020995	82	40	12	3	6
OX-UTDH-87	9341231021008	87	40	12	3	6
OX-UTDH-92	9341231021015	92	40	12	3	6
OX-UTDH-102	9341231021022	102	40	12	3	6
OX-UTDH-107	9341231021039	107	40	12	3	6
OX-UTDH-112	9341231021046	112	40	12	3	6
OX-UTDH-117	9341231021053	117	40	12	3	6
OX-UTDH-122	9341231021060	122	40	12	3	6



Concreting Tools

Concreting is hard work and the OX range has been developed to stand the test of time.

Look at the detail of the products – the quality and thickness of the steel, the perfect amount of flexibility, the positioning of the handles, the quality of the riveting – the complete finish.

A tough range of trowels to cement your reputation.





PRO ADJUSTABLE FORMWORK BRACKET

FEATURES

- Bracket is adjustable to suit 35mm to 50mm timber
- Used for forming 150mm brickwork rebate on house floor slabs

Product code	Barcode	Suits	Inner Qty	Outer Qty
OX-P101950	9341231021336	35 - 50mm	6	12



PRO FIXED FORMWORK BRACKET - 50MM

FEATURES

- Bracket suits 50mm timber
- Used for forming 150mm brickwork rebate on house floor slabs

Product code	Barcode	Suits	Inner Qty	Outer Qty
OX-P103405	9341231024320	2" / 50mm	6	12



TRADE TIE WIRE REEL

FEATURES

- Fits any standard belt
- Suits all types of tie wire
- Left or right hand use
- Cast aluminium construction

Product code	Barcode	Suits	Inner Qty	Outer Qty
OX-T299701	9341231020230	Fits any standard belt	4	12



Suits OX Pro Leather Tool Belt
page 150

TRADE TIE WIRE TWISTER - 310mm

FEATURES

- Smooth operating spiral spindle
- Reinforcing ring to prevent unnecessary wear when hook end returns
- Soft grip

Product code	Barcode	Size	Inner Qty	Outer Qty
OX-T230231	9328217006785	12" / 310mm	4	12





Concreting Tools

PRO TIE WIRE TWISTER - 310mm



FEATURES

- OXGRIP Handle
- Wear resistant bronze sleeve
- Leather re-coil 'stopper'
- Accurately machined spiral spindle

Product code	Barcode	Size	Inner Qty	Outer Qty
OX-P230231	9341231010705	12" / 310mm	4	12

PRO NARROW HEAD END CUTTING NIPPER



FEATURES

- Individually hardened
- Drop forged from special tool steel
- PVC OXGRIP handles
- Max cut thickness 3.2mm / Hardness (Jaw) 61 HRC – OX-P230325
- Max cut thickness 3.5mm / Hardness (Jaw) 61 HRC – OX-P230328

Product code	Barcode	Size	Inner Qty	Outer Qty
OX-P230325	9341231010743	10" / 250mm	6	24
OX-P230328	9341231013560	11" / 280mm	6	24

PRO WIDE HEAD END CUTTING NIPPER



FEATURES

- Individually hardened
- Drop forged from special tool steel
- PVC OXGRIP handles
- Max cut thickness 3.8mm / Hardness (Jaw) 60 HRC

Product code	Barcode	Suits	Inner Qty	Outer Qty
OX-P230420	9341231010750	8" / 200mm	6	24

ULTIMATE NARROW HEAD END CUTTING NIPPER



FEATURES

- Professional quality
- Individually hardened
- Drop forged from special tool steel
- PVC OXGRIP handles
- Max cut thickness 3.2mm / Hardness (Jaw) 61 HRC – OX-U230322
- Max cut thickness 3.5mm / Hardness (Jaw) 61 HRC – OX-U230325
- Max cut thickness 3.5mm / Hardness (Jaw) 61 HRC – OX-U230328

Product code	Barcode	Size	Inner Qty	Outer Qty
OX-U230322	9341231034916	8" / 220mm	6	36
OX-U230325	9341231034923	10" / 250mm	6	36
OX-U230328	9341231034930	11" / 280mm	6	36



ULTIMATE WIDE HEAD END CUTTING NIPPER

FEATURES

- Professional quality
- Individually hardened
- Drop forged from special tool steel
- PVC OXGRIP handles
- Max cut thickness 3.5mm / Hardness (Jaw) 60 HRC - OX-U230418
- Max cut thickness 3.8mm / Hardness (Jaw) 60 HRC - OX-U230420



Product code	Barcode	Size	Inner Qty	Outer Qty
OX-U230420	9341231034954	8" / 200mm	6	36

PRO BOLT CUTTERS

FEATURES

- Heat treated alloy jaws - fully adjustable and replaceable
- Rated to cut HRC40



Product code	Barcode	Size	Inner Qty	Outer Qty
OX-P230118	9341231021343	18" / 450mm	2	4
OX-P230124	9341231021350	24" / 600mm	2	4
OX-P230130	9341231021367	30" / 750mm	2	4
OX-P230136	9341231021374	36" / 900mm	2	4
OX-P230142	9341231021381	42" / 1050mm	2	4

PRO FORGED BOLT CUTTERS

FEATURES

- Alloy steel blade
- Drop forged handle
- Rated to cut HRC40

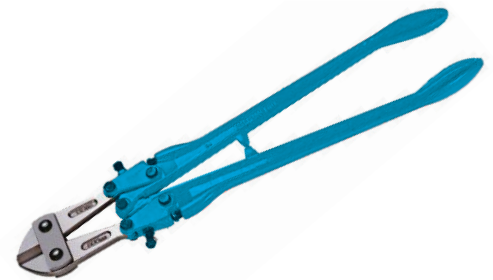

Product code	Barcode	Size	Inner Qty	Outer Qty
OX-P230530	9341231024351	30" / 750mm	2	4
OX-P230536	9341231024368	36" / 900mm	2	4

TRADE REBAR BENDER/CUTTER

FEATURES

- Jaws made of high carbon alloy tool steel - HRC54
- Cuts and bends grade 60 rebar
- Can be bolted to the floor
- Bends 90° and 180°
- Heavy duty
- Max cut 19mm Ø

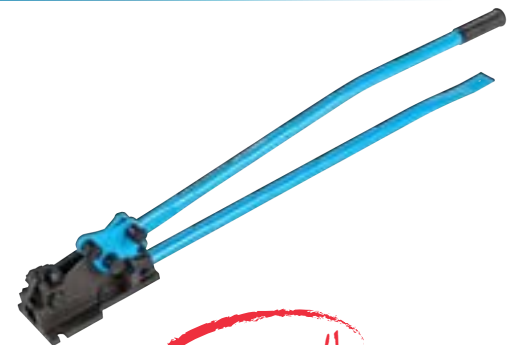

New Improved!

Product code	Barcode	Size	Inner Qty	Outer Qty
OX-T230613	9341231000119	52" / 1320mm	2	6



Concreting Tools

TRADE CONCRETERS SHOVEL - HAMMERTONE



FEATURES

- 'D' grip handle
- All steel, pressed and welded construction with a hammertone finish
- Head size: 250mm x 300mm
- Length: 1040mm

Product code	Barcode	Size	Inner Qty	Outer Qty
OX-T281307	9341231016660	1040mm	0	24

TRADE LIGHTWEIGHT EXTRUSION RAKE



FEATURES

- Lightweight for ease of use
- Extruded rake plate
- 45 degree edge angle
- 1500mm long handle with soft grip

Product code	Barcode	Size	Inner Qty	Outer Qty
OX-T016301	9341231024443	100 x 500mm	4	24

PRO ALUMINIUM CONCRETE RAKE



FEATURES

- 1500mm long handle with soft grip
- Braced for additional strength
- Aluminium construction - powder coated
- 45 degree edge angle

Product code	Barcode	Size	Inner Qty	Outer Qty
OX-P016302	9341231024450	100 x 500mm	4	48



PRO ALUMINIUM CONCRETE RAKE – WITH HOOK

FEATURES

- Braced for additional strength
- With 8mm diameter hook for lifting rebar
- 1500mm long handle with soft grip
- 45 degree edge angle
- Powder coated handle



Product code	Barcode	Size	Inner Qty	Outer Qty
OX-P016303	9341231024467	100 x 500mm	4	48

PRO STRAIGHT EDGE

FEATURES

- High quality extruded aluminium
- Easy to clean powder-coated finish
- Fluted profile - easy to grip extrusion design

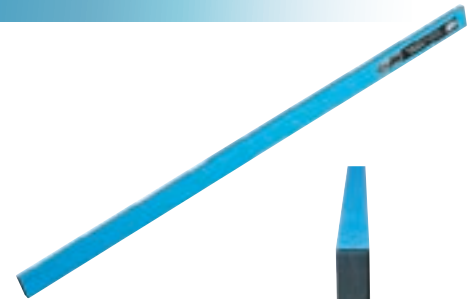

End view

Product code	Barcode	Size (W x H x L)	Inner Qty	Outer Qty
OX-P021612	9341231000386	20 x 70 x 1200mm	4	6
OX-P021615	9341231000393	20 x 70 x 1500mm	4	6
OX-P021618	9341231000409	20 x 70 x 1800mm	4	6
OX-P021621	9341231000416	20 x 70 x 2100mm	4	6
OX-P021624	9341231000423	20 x 70 x 2400mm	4	6
OX-P021627	9341231000430	20 x 70 x 2700mm	4	6
OX-P021630	9341231000447	20 x 70 x 3000mm	4	6
OX-P021636	9341231000454	20 x 70 x 3600mm	4	6

PRO STRAIGHT EDGE SPARE PART

FEATURES

- High quality plastic moulded end caps
- End Cap Set – (2pc)



Product code	Barcode	Suits	Inner Qty	Outer Qty
OX-P029801	9341231021718	Straight Edge	3	6



Concreting Tools

PRO CLAMPED HANDLE SCREED

FEATURES

- Heavy duty structural alloy
- Reversible clamped handle
- Ergonomic grip handle
- Easy to clean powder-coated finish
- Internal strength support bars
- Cutting and pushing edge positioned for comfort
- Profile size 40 x 50mm



Product code	Barcode	Size	Inner Qty	Outer Qty
OX-P021412	9341231000188	1200mm	4	6
OX-P021415	9341231000195	1500mm	4	6
OX-P021418	9341231000201	1800mm	4	6
OX-P021421	9341231000218	2100mm	4	6
OX-P021424	9341231000225	2400mm	4	6
OX-P021427	9341231000232	2700mm	4	6
OX-P021430	9341231000249	3000mm	4	6
OX-P021436	9341231000256	3600mm	4	6

PRO CLAMPED HANDLE SCREED WITH VIAL

FEATURES

- Heavy duty structural alloy
- Reversible clamped handle
- Ergonomic grip handle
- Easy to clean powder-coated finish
- Internal strength support bars
- Cutting and pushing edge positioned for comfort
- Profile size 40 x 50mm
- Built in vial for easy levelling

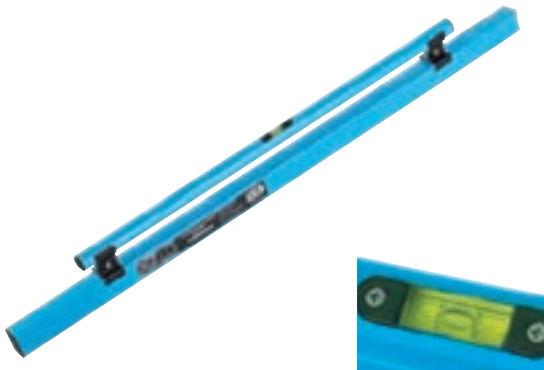

Product code	Barcode	Size	Inner Qty	Outer Qty
OX-P021312	9341231000973	1200mm	4	6
OX-P021318	9341231000997	1800mm	4	6
OX-P021324	93412310001017	2400mm	4	6
OX-P021330	9341231001031	3000mm	4	6
OX-P021336	9341231001048	3600mm	4	6



PRO SCREED SPARE PART

FEATURES

- OX-P021901 suits clamped handle screed
- OX-P021902 suits clamped handle screed with vial

Product code	Barcode	Description	Inner Qty	Outer Qty
OX-P021901	9341231021640	Handle	2	4
OX-P021902	9341231021657	Handle with vial	2	4

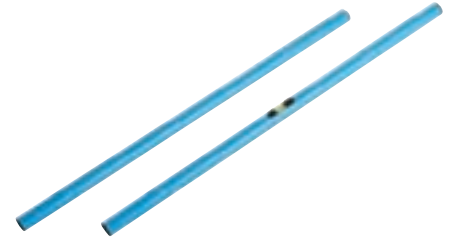

- OX-P021903 suits fixed screed handle

Product code	Barcode	Description	Inner Qty	Outer Qty
OX-P021903	9341231021664	Clamp Set - (2)	3	6

- OX-P021904 suits clamped screed handle

Product code	Barcode	Description	Inner Qty	Outer Qty
OX-P021904	9341231021671	Clamp Set - (2)	3	6



- OX-P021904 suits clamped screed handle

Product code	Barcode	Description	Inner Qty	Outer Qty
OX-P021905	9341231021688	End Cap Set - (2)	3	6
OX-P021906	9341231021695	End Cap Set - (2)	3	6
OX-P021907	9341231021701	End Cap Set - (2)	3	6

PRO ALUMINIUM BULLFLOAT

FEATURES

- Heavy duty structural alloy
- Easy to clean powder coated finish
- Extruded ribs for extra strength

Product code	Barcode	Size	Inner Qty	Outer Qty
OX-P016606	9341231000928	150 x 600mm	2	4
OX-P016609	9341231000935	150 x 900mm	2	4
OX-P016612	9341231000942	150 x 1200mm	2	4



PRO ALUMINIUM BULLFLOAT – MILL FINISH

FEATURES

- Heavy duty structural alloy
- Mill finish for perfect finishing
- Extruded ribs for extra strength

Product code	Barcode	Size	Inner Qty	Outer Qty
OX-P016406	9341231024481	150 x 600mm	2	4
OX-P016409	9341231024498	150 x 900mm	2	4
OX-P016412	9341231024504	150 x 1200mm	2	4
OX-P016415	9341231024511	150 x 1500mm	2	4
OX-P016418	9341231024528	150 x 1800mm	2	4





Concreting Tools

PRO REPLACEMENT TILT MECHANISM



FEATURES

- Suits the powder-coated and milled finished bullfloats

Product code	Barcode	Size	Inner Qty	Outer Qty
OX-P029601	9341231021633	-	3	6

PRO TELESCOPIC HANDLE



FEATURES

- Powder coated finish
- Fluted profile
- H.D.P.E screw-lock fitting
- "T" section "Twist Stop" extrusion design
- High quality extruded aluminium
- Comes with universal adaptor included

Product code	Barcode	Size	Inner Qty	Outer Qty
OX-P016524	9341231000829	1300 - 2400mm	4	12
OX-P016550	9341231000836	2700 - 5000mm	4	12

PRO TELESCOPIC HANDLE PARTS



FEATURES

- Suits OX-P016524 and OX-P016550

Product code	Barcode	Description	Inner Qty	Outer Qty
OX-P019501	9341231021626	Replacement Plastic Collet / End Cap	6	12
OX-P019710	9341231013591	Replacement Quick Release Pin	12	36
OX-P409901	9341231015854	Telescopic Handle Adaptor		

PRO CLIP TOGETHER HANDLE



FEATURES

- High quality extruded aluminium
- Snap together for fast tool changes

Product code	Barcode	Size	Inner Qty	Outer Qty
OX-P019020	9341231024573	1800mm	4	12
OX-P019024	9341231025938	2400mm	4	12

PRO CLIP TOGETHER HANDLE ADAPTERS



FEATURES

- High quality extruded aluminium
- Available to suit all major manufacturers

Product code	Barcode	Description	Inner Qty	Outer Qty
OX-P019101	9341231024580	OX Male fitting	6	12
OX-P019102	9341231024597	OX Female fitting	6	12



PRO NARROW GROOVER

FEATURES

- High grade stainless steel blade
- Reversible OXGRIP handle
- Groove: Width 5/8" - 5/16" 15-8mm
Depth 3/8" 10mm (OX-P014210), 3/4" 19mm (OX-P014219)



Product code	Barcode	Size	Inner Qty	Outer Qty
OX-P014210	9341231011269	3 x 7" / 75 x 180mm	4	12
OX-P014219	9341231011276	3 x 7" / 75 x 180mm	4	12

PRO WIDE GROOVER

FEATURES

- High grade stainless steel blade
- Reversible OXGRIP handle
- Groove: Width 5/8" - 5/16" 15-8mm
Depth 1/2" 12mm (OX-P014312), 25/32" 20mm (OX-P014320)



Product code	Barcode	Size	Inner Qty	Outer Qty
OX-P014312	9341231011283	6 x 7" / 155 x 180mm	4	12
OX-P014320	9341231011276	6 x 7" / 155 x 180mm	4	12

PRO GROOVER

FEATURES

- High grade stainless steel blade
- Reversible OXGRIP handle
- Groove: Width 3/16" 4.8mm
Depth 3/8" 10mm



Product code	Barcode	Size	Inner Qty	Outer Qty
OX-P012510	9341231021428	3 1/2 x 6" / 90 x 150mm	4	12

TRADE NARROW EDGER

FEATURES

- Carbon steel blade
- One piece ergonomic plastic handle
- Blade size: 6 x 3" / 150 x 75mm



Product code	Barcode	Radius / Depth	Inner Qty	Outer Qty
OX-T016806	9341231010320	6mm, 12mm	4	12
OX-T016810	9341231010347	10mm, 19mm	4	12
OX-T016819	9341231010354	19mm, 19mm	4	12



Concreting Tools

TRADE MEDIUM EDGER



FEATURES

- Carbon steel blade
- One piece ergonomic plastic handle
- Blade size: OX-T016906 – 4 x 5" / 100 x 150mm
- Blade size: OX-T016910 – 4 x 5" / 100 x 150mm

Product code	Barcode	Radius / Depth	Inner Qty	Outer Qty
OX-T016906	9341231010361	6mm, 19mm	4	12
OX-T016910	9341231010378	10mm, 14mm	4	12

TRADE WIDE EDGER



FEATURES

- Carbon steel blade
- One piece ergonomic plastic handle
- Blade size: OX-T017012 – 7 x 4¼" / 175 x 112mm
- Blade size: OX-T017020 – 8 x 5½" / 200 x 140mm

Product code	Barcode	Radius / Depth	Inner Qty	Outer Qty
OX-T017012	9341231010385	12mm, 22mm	4	12
OX-T017020	9341231010392	20mm, 19mm	4	12

TRADE EXTRA WIDE EDGER

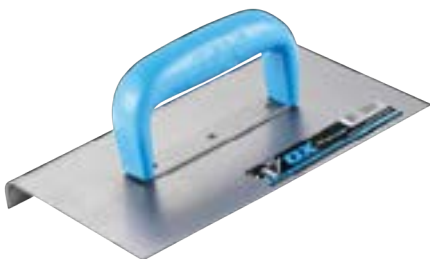

FEATURES

- Carbon steel blade
- One piece ergonomic plastic handle
- Blade size: 9 x 6" / 230 x 150mm

Product code	Barcode	Radius / Depth	Inner Qty	Outer Qty
OX-T017112	9341231010415	12mm, 24mm	4	12
OX-T017125	9341231010422	25mm, 24mm	4	12



PRO NARROW EDGER

FEATURES

- High grade stainless steel blade
- Rivetted handle support
- Reversible OXGRIP handle
- Blade size: 3 x 7" / 75 x 180mm



Product code	Barcode	Radius / Depth	Inner Qty	Outer Qty
OX-P014406	9341231011092	6mm, 12mm	4	12
OX-P014410	9341231011108	10mm, 19mm	4	12

PRO MEDIUM EDGER

FEATURES

- High grade stainless steel blade
- Rivetted handle support
- Reversible OXGRIP handle
- Blade size: 4 x 7" / 100 x 180mm



Product code	Barcode	Radius / Depth	Inner Qty	Outer Qty
OX-P014506	9341231011115	6mm, 14mm	4	12
OX-P014510	9341231011122	10mm, 14mm	4	12
OX-P014519	9341231011139	19mm, 19mm	4	12

PRO WIDE EDGER

FEATURES

- High grade stainless steel blade
- Rivetted handle support
- Reversible OXGRIP handle
- Blade size: 5 x 7½" / 130 x 190mm



Product code	Barcode	Radius / Depth	Inner Qty	Outer Qty
OX-P014812	9341231011146	12mm, 22mm	4	12
OX-P014820	9341231011153	20mm, 22mm	4	12
OX-P014825	9341231011160	25mm, 22mm	4	12

PRO EXTRA WIDE EDGER

FEATURES

- High grade stainless steel blade
- Rivetted handle support
- Reversible OXGRIP handle
- Blade size: 5¾ x 8½" / 145 x 215mm



Product code	Barcode	Radius / Depth	Inner Qty	Outer Qty
OX-P014910	9341231011306	10mm, 12mm	4	12
OX-P014912	9341231011177	12mm, 24mm	4	12
OX-P014916	9341231011313	16mm, 16mm	4	12
OX-P014925	9341231011184	25mm, 24mm	4	12



Concreting Tools

PRO STEP EDGER



FEATURES

- High grade stainless steel blade
- Rivetted handle support
- Reversible OXGRIP handle
- Blade size: 4 x 7" / 100 x 180mm

Product code	Barcode	Radius / Depth	Inner Qty	Outer Qty
OX-P015110	9341231011191	10mm, 50mm	4	12

PRO SAFETY STEP EDGER



FEATURES

- High grade stainless steel blade
- Reversible OXGRIP handle - rivetted handle support
- Cuts 4 grooves while edging the step
- Blade size: 5x7" / 120 x 180mm

Product code	Barcode	Radius / Depth	Inner Qty	Outer Qty
OX-P019312	9341231024689	10mm, 50mm	4	12

PRO COVING TROWEL



FEATURES

- High grade stainless steel blade
- Reversible OXGRIP handle - rivetted handle support
- Blade size: 4 x 7" / 100 x 180mm

Product code	Barcode	Radius / Depth	Inner Qty	Outer Qty
OX-P015010	9341231021435	4 x 7" / 100 x 180mm	4	12

PRO TIMBER FLOAT



FEATURES

- OXGRIP 'High lift' handle design
- High quality hardwood blade
- Special timber screws to prevent 'backing out'

Product code	Barcode	Size	Inner Qty	Outer Qty
OX-P012212	9341231013034	4½ x 12" / 112 x 300mm	4	12
OX-P012215	9341231013461	4½ x 15" / 112 x 380mm	4	12
OX-P012218	9328217006976	4½ x 18" / 112 x 450mm	4	12
OX-P012318	9341231020322	2½ x 18" / 50 x 450mm	4	12
OX-P012324	9328217006990	2½ x 24" / 65 x 600mm	4	12



PRO SPINNER FLOAT

FEATURES

- High grade stainless steel blade - 'dished design'
- Reversible OXGRIP handle



Product code	Barcode	Size	Inner Qty	Outer Qty
OX-P014112	9341231021206	4 3/4 x 11 1/2" / 120 x 290mm	4	12
OX-P014114	9341231021213	5 1/4 x 8" / 145 x 215mm	4	12

PRO ALL SIDES UP FLOAT

FEATURES

- High grade stainless steel blade
- Reversible OXGRIP handle



Product code	Barcode	Size	Inner Qty	Outer Qty
OX-P013910	9341231020452	4 x 11 1/2" / 100 x 290mm	4	12
OX-P013916	9341231020469	6 1/4 x 8 1/4" / 160 x 210mm	4	12

PRO ALL SIDES UP FLOAT

FEATURES

- High grade stainless steel blade - 'dished design'
- Reversible OXGRIP handle



Product code	Barcode	Size	Inner Qty	Outer Qty
OX-P013938	9341231020476	6 x 15" / 150 x 380mm	4	12

PRO MAGNESIUM FLOAT – OXGRIP HANDLE

FEATURES

- High grade stainless steel blade - 'dished design'
- Reversible OXGRIP handle



Product code	Barcode	Size	Inner Qty	Outer Qty
OX-P017012	9341231024900	3 x 12" / 80 x 300mm	4	12
OX-P017016	9341231011030	3 x 16" / 80 x 400mm	4	12
OX-P017020	9341231011047	3 x 20" / 80 x 500mm	4	12



Concreting Tools

PRO MAGNESIUM FLOAT – ROUNDED ENDS



FEATURES

- Heavy duty magnesium blade
- Ergonomic OXGRIP handle
- Fully rounded ends helps prevent float marks

Product code	Barcode	Size	Inner Qty	Outer Qty
OX-P400416	9341231024917	3 x 8" / 80 x 400mm	4	12

PRO MAGNESIUM FLOAT – WIDE BLADE



FEATURES

- Heavy duty magnesium blade
- Ergonomic OXGRIP handle
- Wide blade wears longer

Product code	Barcode	Size	Inner Qty	Outer Qty
OX-P400517	9341231024924	3½ x 16" / 90 x 400mm	4	12

TRADE POINTED FINISHING TROWEL



FEATURES

- Carbon steel blade
- One piece ergonomic plastic handle

Product code	Barcode	Size	Inner Qty	Outer Qty
OX-T017309	9341231010446	4 x 14" / 100 x 335mm	4	12
OX-T017301	9341231010453	4½ x 14" / 120 x 356mm	4	12
OX-T017391	9341231010460	4½ x 16" / 115 x 405mm	4	12
OX-T017392	9341231010477	4½ x 17¾" / 115 x 450mm	4	12

PRO POINTED FINISHING TROWEL



FEATURES

- High grade stainless steel blade
- Heavy duty aluminium shank
- 'Double hung' OXGRIP handle
- Stainless steel rivets holds the blade, shank and handle together with unsurpassed strength

Product code	Barcode	Size	Inner Qty	Outer Qty
OX-P014609	9341231011214	4 x 14" / 100 x 335mm	4	12
OX-P014601	9341231011207	4¾ x 14" / 120 x 356mm	4	12
OX-P014691	9341231011238	4½ x 16" / 115 x 405mm	4	12
OX-P014692	9341231011245	4½ x 17¾" / 115 x 450mm	4	12
OX-P014693	9341231011252	4½ x 19½" / 115 x 500mm	4	12
OX-P014665	9341231011221	4½ x 24" / 115 x 600mm	4	12



PRO POOL TROWEL – FLEXIBLE

FEATURES

- Heavy duty aluminium shank
- 'Double hung' OXGRIP handle
- Stainless steel rivets holds the blade, shank and handle together with unsurpassed strength
- High grade stainless steel blade



Product code	Barcode	Size	Inner Qty	Outer Qty
OX-P015712	9328217001308	4 x 11¾" / 100 x 300mm	4	12
OX-P015714	9341231013751	4 x 14" / 100 x 356mm	4	12
OX-P015718	9341231013768	4 x 18" / 100 x 457mm	4	12

PRO POOL TROWEL – RIGID

FEATURES

- Heavy duty aluminium shank
- OXGRIP handle
- Stainless steel rivets holds the blade, shank and handle together with unsurpassed strength
- High grade stainless steel blade



Product code	Barcode	Size	Inner Qty	Outer Qty
OX-P015818	9341231013782	4½ x 17¾" / 110 x 450mm	4	12

PRO SQUARE FINISHING TROWEL

FEATURES

- Heavy duty aluminium shank
- Double hung' OXGRIP handle
- Stainless steel rivets holds the blade, shank and handle together with unsurpassed strength
- High grade stainless steel blade



Product code	Barcode	Size	Inner Qty	Outer Qty
OX-P014702	9341231013799	4¾ x 11" / 120 x 280mm	4	12
OX-P014773	9341231013805	4¾ x 14" / 120 x 356mm	4	12
OX-P014781	9341231013812	4½ x 16" / 115 x 405mm	4	12



Concreting Tools

PRO WIDE WALKING EDGER



FEATURES

- High grade stainless steel blade
- Rivetted handle support
- Complete with fixed walking bracket
- Blade size: 5½ x 6¼" / 140 x 160mm

Product code	Barcode	Radius / Depth	Inner Qty	Outer Qty
OX-P401310	9341231025051	10mm, 12mm	4	12
OX-P401316	9341231025068	16mm, 18mm	4	12
OX-P401320	9341231025075	20mm, 20mm	4	12

PRO NARROW WALKING GROOVER



FEATURES

- High grade stainless steel blade
- Complete with fixed walking bracket
- Groove: Width 5/8" - 5/16" 15-8mm
- Depth ¾" 19mm

Product code	Barcode	Size	Inner Qty	Outer Qty
OX-P401203	9341231025044	3 x 6 ¼" / 75 x 160mm	4	32

PRO WIDE WALKING GROOVER



FEATURES

- High grade stainless steel blade
- Complete with fixed walking bracket
- Groove: Width 5/8" - 5/16" 15-8mm
- Depth ¾" 19mm

Product code	Barcode	Size	Inner Qty	Outer Qty
OX-P401206	9341231025037	6 x 6" / 150 x 160mm	4	24

PRO WALKING FLOAT



FEATURES

- High grade stainless steel blade
- Complete with fixed standing bracket

Product code	Barcode	Size	Inner Qty	Outer Qty
OX-P401416	9431231025099	6¼ x 8¼" / 160 x 210mm	4	12
OX-P401438	9341231025105	6 x 15" / 150 x 380mm	4	12



PRO FIXED BRACKET WALKING TROWEL

FEATURES

- Complete with fixed bracket
- High grade stainless steel

Product code	Barcode	Size	Inner Qty	Outer Qty
OX-P402760	9341231034374	4¼ x 24" / 120 x 600mm	2	6
OX-P402790	9341231034381	4¼ x 36" / 120 x 900mm	2	6



PRO ROTATING BRACKET WALKING TROWEL

FEATURES

- Complete with Fresno Bracket
- High grade stainless steel

Product code	Barcode	Size	Inner Qty	Outer Qty
OX-P402860	9341231034398	4¼ x 24" / 120 x 600mm	2	6
OX-P402890	9341231034404	4¼ x 36" / 120 x 900mm	2	6



PRO TILT BRACKET WALKING TROWEL

FEATURES

- Complete with tilt bracket
- High grade stainless steel

Product code	Barcode	Size	Inner Qty	Outer Qty
OX-P402960	9341231034411	4¼ x 24" / 120 x 600mm	2	6
OX-P402990	9341231034428	4¼ x 36" / 120 x 900mm	2	6



PRO WALKING TROWEL STANDING BRACKET

FEATURES

- Zinc plated steel
- Fully adjustable
- 25mm Ø Fitting

Product code	Barcode	Size	Inner Qty	Outer Qty
OX-P016203	9341231021589	-	4	12





Concreting Tools

PRO WALKING TROWEL MECHANISM

FEATURES

- Zinc plated steel
- Fully adjustable
- 25mm Ø Fitting

Product code	Barcode	Size	Inner Qty	Outer Qty
OX-P016201	9341231021596	-	6	48
OX-P016202	9341231021602	-	4	12
OX-P016204	9341231021619	-	4	12

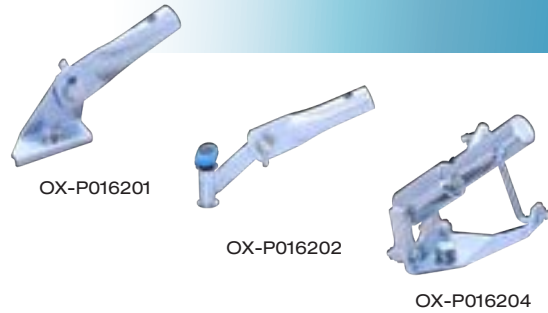

PRO 750MM H/D FLOOR SQUEEGEE HEAD

FEATURES HEAD ONLY

- Red neoprene - excellent resistance to salt acids, gasoline, fats, grease, etc.
- Rust resistant galvanised steel frame, etc.
- Splash guard and reinforced handle socket
- Parallel fitting: 25mm

Product code	Barcode	Size	Inner Qty	Outer Qty
OX-P250575	9341231013904	29½" x 750mm	4	12



PRO TRADITIONAL FLOOR SQUEEGEE

FEATURES

- Hard rubber blade & pre-galvanised steel frame
- Tapered fitting
- Fitting: 27-20mm

Product code	Barcode	Size	Inner Qty	Outer Qty
OX-P250691	9341231013911	36" / 910mm	4	12



PRO CONCRETE FINISHING BROOM

FEATURES

- Cast aluminium back
- Premium fibre bristles
- Complete with adaptor to suit telescopic handle

Product code	Barcode	Size	Inner Qty	Outer Qty
OX-P060390	9341231021497	36" / 900mm	2	6





PRO RUB BRICK

FEATURES

- Fluted silicone carbide
- Contoured one piece plastic handle



Product code	Barcode	Size	Inner Qty	Outer Qty
OX-P071008	9341231025181	8 x 3½" / 200 x 90mm	6	12

PRO RUB BRICK – ROUND

FEATURES

- Silicone carbide
- Contoured one piece plastic handle



Product code	Barcode	Size	Inner Qty	Outer Qty
OX-P071106	9341231025198	6 x 1" / 150 x 20mm	6	12

TRADE KNEELING BOARD

FEATURES

- One piece base - with built in extra grip handles
- One piece foam
- Firm foam for greater knee support

Product code	Barcode	Size	Inner Qty	Outer Qty
OX-T240300	9341231001284	350 x 480mm	10	20





Concreting Tools

PRO INDUSTRIAL CONCRETE SPRAYER - 13.2L

FEATURES

- Stainless steel heavy duty pump
- Stainless steel spray wand
- Stainless steel tank
- Flexible heavy duty chemical resistant hose
- Superior lock-on trigger assembly
- Ergonomic pump handle
- Genuine OXSeals equipped
- Wide mouth opening for easy filling & cleaning
- Holster for wand & nozzle storage
- Includes 13pc seal & repair kit

Product code	Barcode	Size	Inner Qty	Outer Qty
OX-P040713	9341231014413	13.2L	20	40





PRO CONCRETE SPRAYER REPLACEMENT PARTS LIST

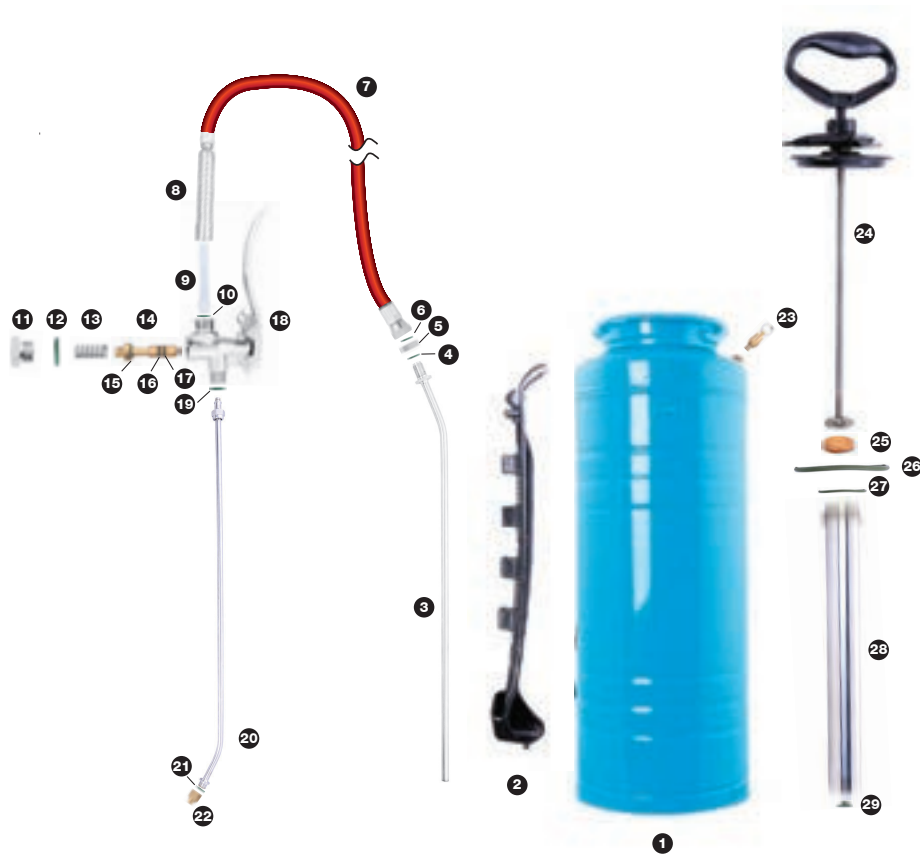

PARTS LIST
1. TANK
2. WAND HOLSTER
3. INLET TUBE
4. O RING SEAL
5. NUT
6. O RING SEAL
7. HOSE
8. END CAP
9. PLASTIC FILTER
10. O RING SEAL
11. END CAP
12. O RING SEAL
13. SPRING
14. SPINDLE
15. O RING SEAL
16. O RING SEAL
17. O RING SEAL
18. HANDLE HOUSING & TRIGGER
19. O RING SEAL
20. WAND
21. O RING SEAL
22. NOZZLE
23. RELIEF VALVE
24. PUMP HANDLE D PLUNGER
25. BRASS WASHER
26. O RING SEAL
27. O RING SEAL
28. BARREL
29. END PIN

Product code	Description	Parts Included
OX-P049301	OX Brass Fan Nozzle - 1.0 GPM (3.8LPM)	17
OX-P049302	OX 600mm Stainless Steel Spray Wand	14,15 & 16
OX-P049303	OX Trigger Assembly	7, 8, 9, 10, 11,12 & 13
OX-P049304	OX 1200mm Chemical Resistant Hose with Connections	6
OX-P049305	OX Genuine OXSeal and Gasket Kit	4, 5, 9, 13, 14, 16, 21, 22, 23 & 25
OX-P049306	OX Stainless Steel Pump Assembly	20, 21, 22, 23, 24 & 25
OX-P049307	OX Plunger Assembly	20 & 21
OX-P049310	OX Supply Tube Assembly	3, 4 & 5



Concreting Tools

TRADE REPLACEMENT BLADES – STYLE 1 COMBINATION BLADE SET (4)



FEATURES

- Suitable for 34" machines
- 3/8" BSW threads
- Heat treated - for better wear
- Boxed for easy storage

Product Code	Barcode	No. of Threaded Holes	Size	Inner Qty	Outer Qty
OX-T181401	9341231000720	2	322x187mm	1	1

Suits: Master Finish 34" / Coates 34" / Cromellins 34" / Flextool 34"

TRADE REPLACEMENT BLADES – STYLE 2 COMBINATION BLADE SET (4)



FEATURES

- Suitable for 40" machines
- 3/8" BSW threads
- Heat treated - for better wear

Product Code	Barcode	No. of Threaded Holes	Size	Inner Qty	Outer Qty
OX-T181402	9341231000737	3	375x202mm	1	1

Suits: OX-PT40 / Master Finish 40" / Cromellins 40" / Flextool 40"

TRADE REPLACEMENT BLADES – STYLE 3 COMBINATION BLADE SET (4)



FEATURES

- Suitable for 46" & 48" machines
- 5/16" UNC threads
- Heat treated - for better wear
- 12 x replacement square head bolts included

Product Code	Barcode	No. of Threaded Holes	Size	Inner Qty	Outer Qty
OX-T181403	9341231000744	6	450x187mm	1	1

Suits: OX-PT46 / Master Finish 48" / Flextool 46" / Wackers 46" / Bartell 46"

TRADE REPLACEMENT BLADES – STYLE 4 COMBINATION BLADE SET (4)



FEATURES

- Suitable for 34" machines
- 16 x replacement square head bolts and locking nuts included
- Heat treated - for better wear

Product Code	Barcode	No. of Threaded Holes	Size	Inner Qty	Outer Qty
OX-T181404	9341231000751	3	322x187mm	1	1

Suits: Master Finish 34"

TRADE REPLACEMENT BLADES – STYLE 5 COMBINATION BLADE SET (4)



FEATURES

- Suitable for 40" machines
- 16 x replacement square head bolts and locking nuts included
- Heat treated - for better wear

Product Code	Barcode	No. of Threaded Holes	Size	Inner Qty	Outer Qty
OX-T181405	9341231000768	4	375x200mm	1	1

Suits: Master Finish 40"



TRADE REPLACEMENT BLADES – STYLE 6 COMBINATION BLADE SET (4)

FEATURES

- Suitable for 34" & 36" machines
- 8 x replacement bolts
- 5/16" UNC threads

Product Code	Barcode	No. of Threaded Holes	Size	Inner Qty	Outer Qty
OX-T181406	9341231000775	3	355x187mm	1	1

Suits: OX-PT34 / Suits: OX-PT36 / Flextool 36" / Wackers 36" / Bartell 36" / Bartell 40"



TRADE REPLACEMENT BLADES – STYLE 7 FINISHING BLADE SET (4)

FEATURES

- Suitable for 46" & 48" machines
- Heat treated - for better wear
- 5/16" UNC threads

Product Code	Barcode	No. of Threaded Holes	Size	Inner Qty	Outer Qty
OX-T181407	9341231000782	6	455x152mm	1	1

Suits: OX-PT46 / Master Finish 48" / Flextool 46" / Wackers 46" / Bartell 46"



TRADE REPLACEMENT BLADES – STYLE 8 FINISHING BLADE SET (4)

FEATURES

- Suitable for 40" machines
- Heat treated - for better wear
- 3/8" BSW threads

Product Code	Barcode	No. of Threaded Holes	Size	Inner Qty	Outer Qty
OX-T181408	9341231000799	3	375x152mm	1	1

Suits: OX-PT40 / Master Finish 40" / Flextool 40" / Cromellins 40"



TRADE REPLACEMENT BLADES – STYLE 9 FINISHING BLADE SET (4)

FEATURES

- Suitable for 36" machines
- Heat treated - for better wear
- 5/16" UNC threads

Product Code	Barcode	No. of Threaded Holes	Size	Inner Qty	Outer Qty
OX-T181409	9341231000805	3	375x152mm	1	1

Suits: OX-PT34 / OX-PT36 / Flextool 36" / Wackers 36" / Bartell 36"



TRADE REPLACEMENT BLADES – STYLE 10 FINISHING BLADE SET (4)

FEATURES

- Suitable for 24" edging machines
- Heat treated - for better wear
- M16 threads

Product Code	Barcode	No. of Threaded Holes	Size	Inner Qty	Outer Qty
OX-T181410	9341231000812	2	230x120mm	1	1

Suits: OX-PT24 / Flextool 24" / Bartell 24"





Bricklaying Tools

Bricklaying is a highly skilled trade and is characterised by regional variations in both brick size/shape & laying techniques.

We have spent 4 years 'Living the trade' with bricklayers & liaising with training institutions around the world to ensure our products are second to none.

From the strength of the forged steel to the perfect weight & balance – these tools symbolise quality. Guaranteed better than the rest!







Bricklaying Tools

PRO POINTING TROWEL



FEATURES

- OXGRIP handle
- Welded shank
- Precision taper ground blade

Product code	Barcode	Size	Inner Qty	Outer Qty
OX-P013606	5060242330308	2¾" x 6" / 70 x 152mm	4	12

PRO GAUGING TROWEL



FEATURES

- OXGRIP handle
- Welded shank
- Flexible precision taper ground blade

Product code	Barcode	Size	Inner Qty	Outer Qty
OX-P011307	5060242330261	3½ x 7" / 88 x 178mm	4	12
OX-P011308	9341231010804	3½ x 8" / 95 x 203mm	4	12

PRO BRICK TROWEL – PHILADELPHIA



FEATURES

- New Ergonomically Designed OXGRIP Handle
- Fully Thermoplastic Rubber (TPR)
- Indestructible End Cap for longer lasting wear
- Perfectly Balanced Handle and Blade
- Blade Forged, Heat Treated and Ground from One Piece of Steel

Product code	Barcode	Size	Inner Qty	Outer Qty
OX-P011212	5060242330629	12" / 300mm	4	12

PRO BRICK TROWEL – LONDON



FEATURES

- New Ergonomically Designed OXGRIP Handle
- Fully Thermoplastic Rubber (TPR)
- Indestructible End Cap for longer lasting wear
- Perfectly Balanced Handle and Blade
- Blade Forged, Heat Treated and Ground from One Piece of Steel

Product code	Barcode	Size	Inner Qty	Outer Qty
OX-P011112	9341231020445	12" / 300mm	4	12



PRO BRICK TROWEL - LONDON

FEATURES

- Quality carbon steel blade
- OXGRIP handle
- Welded shank

Product code	Barcode	Size	Inner Qty	Outer Qty
OX-P010312	9341231022036	6 x 12" / 150 x 302mm	4	12



PRO MARGIN TROWEL

FEATURES

- High quality carbon steel
- Flat rectangular blade
- OXGRIP handle for extreme comfort
- Precision tapered ground blade

Product code	Barcode	Size	Inner Qty	Outer Qty
OX-P013416	9341231014321	2" x 6" / 50 x 150mm	4	12



PRO MORTAR SMOOTHING TOOL

FEATURES

- OXGRIP handle
- Bright steel finish
- One piece spring steel

Product code	Barcode	Size	Inner Qty	Outer Qty
OX-P011506	9341231013522	285 x 6mm	4	12
OX-P011508	9341231013249	285 x 8mm	4	12
OX-P011510	5060242330346	285 x 10mm	4	12
OX-P011512	5060242330285	285 x 12mm	4	12



PRO SPOON JOINTER

FEATURES

- High quality carbon steel
- One piece spring steel

Product code	Barcode	Size	Inner Qty	Outer Qty
OX-P030813	9341231011368	3/8 & 1/2" / 10 & 13mm	4	12
OX-P030816	9341231011375	1/2 & 5/8" / 13 & 16mm	4	12
OX-P030819	9341231034329	5/8 & 3/4" / 16 & 19mm	4	12
OX-P030822	9341231034336	3/4 & 7/8" / 19 & 22mm	4	12





Bricklaying Tools

PRO STEEL BRICK JOINTER

FEATURES

- OXGRIP handle
- High quality bright steel

Product code	Barcode	Size	Inner Qty	Outer Qty
OX-P030310	9341231013256	495 x 10mm	4	12
OX-P030312	9341231013263	495 x 12mm	4	12



PRO FLEXIGLASS BRICK JOINTER

FEATURES

- OXGRIP handle
- One piece moulded acrylic
- Non stain acrylic for rolled joints
- Used for light coloured mortar - doesn't burn

Product code	Barcode	Size	Inner Qty	Outer Qty
OX-P030210	9341231022043	495 x 10mm	4	12
OX-P030212	9341231022050	495 x 12mm	4	12



PRO NON STAIN ROLL JOINTER

FEATURES

- Made from hardened acrylic material
- Will not mark or discolour white mortar
- 230mm in length
- Chamfered end

Product code	Barcode	Size	Inner Qty	Outer Qty
OX-P031209	9341231037580	25 x 230mm	6	12



PRO DOUBLE ENDED BALL JOINTER

FEATURES

- Ball head for consistent joints from any angle
- Small design
- Two sizes in one tool

Product code	Barcode	Size	Inner Qty	Outer Qty
OX-P031322	9341231015878	22mm & 19mm	10	50





PRO POLY WHEEL ROLLER RAKER

FEATURES

- OXGRIP handle
- Adjustable rake depth
- Zinc plated
- Steel frame



Product code	Barcode	Size	Inner Qty	Outer Qty
OX-P030501	9341231020285	220 x 93mm	4	12

PRO ALL STEEL ROLLER RAKER

FEATURES

- OXGRIP handle
- Adjustable rake depth
- Steel wheels
- Steel frame



Product code	Barcode	Size	Inner Qty	Outer Qty
OX-P030703	9341231020735	220 x 75mm	4	12

PRO JOINT ROLLER RAKER

FEATURES

- OXGRIP handle
- Adjustable rake depth
- Poly wheels
- Steel frame



Product code	Barcode	Size	Inner Qty	Outer Qty
OX-P030115	9341231022067	275 x 120mm	4	12

PRO BRICK JOINT RAKER

FEATURES

- Designed for clearing out mortar from between brickwork prior to pointing
- Strong aluminium handle contoured to fit the hand
- Two hard wearing wheels and replaceable point



Product code	Barcode	Size	Inner Qty	Outer Qty
OX-P031003	9341231035364	8 1/2" x 3"	4	12



Bricklaying Tools

PRO DUTCH PIN - SWIVEL

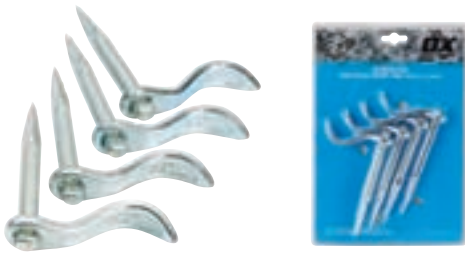

FEATURES

- Semi-round swivel arm
- Solid forged and hardened
- Made from special high quality steel
- Galvanised
- 100 x 150mm

Product code	Barcode	Pack Qty	Inner Qty	Outer Qty
OX-P100715	9328217003364	4	4	16

PRO DUTCH PIN - FIXED



FEATURES

- Semi-round fixed arm
- Solid forged and hardened
- Made from special high quality steel
- Galvanised
- 100 x 150mm

Product code	Barcode	Pack Qty	Inner Qty	Outer Qty
OX-P100615	9341231013614	4	4	16
OX-P100615B	9341231024350	100	2	4

TRADE STRING LINE - 8 GAUGE



FEATURES

- Tough synthetic high tensile strength (42.8kg / 855 Tex)
- Ideal for layout work, brick and block laying
- Flexible plastic spool

Product code	Barcode	Size	Inner Qty	Outer Qty
OX-T102805	9341231013102	Fluro Lime / 50m	12	48
OX-T102810	9341231013119	Fluro Lime / 100m	12	48
OX-T102905	9341231013126	Fluro Pink / 50m	12	48
OX-T102910	9341231013133	Fluro Pink / 100m	12	48
OX-T103005	9341231013140	White / 50m	12	48
OX-T103010	9341231013157	White / 100m	12	48

TRADE STRING LINE - 12 GAUGE



FEATURES

- Tough synthetic high tensile strength (66.5kg / 1345 Tex)
- Ideal for layout work, brick and block laying
- Flexible plastic spool

Product code	Barcode	Size	Inner Qty	Outer Qty
OX-T103205	9341231013287	Fluro Lime / 50m	12	48
OX-T103210	9341231013294	Fluro Lime / 100m	12	48



PRO RUBBER LINE BLOCK – SINGLE

FEATURES

- One piece rubber
- OXGRIP

Product code	Barcode	Size	Inner Qty	Outer Qty
OX-P101801	9341231001246	61 x 41 x 35mm	12	96



PRO RUBBERISED LINE BLOCK – PAIR

FEATURES

- One piece
- Rubberised OXGRIP

Product code	Barcode	Size	Inner Qty	Outer Qty
OX-P101502	9341231001239	75 x 65 x 57mm	12	40



TRADE PLASTIC LINE BLOCK – PAIR

FEATURES

- High impact plastic
- High visibility blue colour

Product code	Barcode	Size	Inner Qty	Outer Qty
OX-T101601	9341231011351	75 x 65 x 57mm	6	18



PRO LINE PIN

FEATURES

- Made from solid forged carbon steel for ultimate strength
- Taper ground point & edges – drives easily into the wall
- Chrome plated for fine finish, extra wear resistance and rust prevention

Product code	Barcode	Pack Qty	Inner Qty	Outer Qty
OX-P100101	9341231012935	1	6	24





Bricklaying Tools

PRO PROFILE CLAMP



FEATURES

- Solid steel & zinc plated
- 'T' bolt thumb screw
- Thread length 80mm

Product code	Barcode	Size	Inner Qty	Outer Qty
OX-P100302	9341231013829	50mm	4	12
OX-P100307	9341231020216	180mm	4	12
OX-P100312	9341231020223	300mm	4	12

PRO 'T' PROFILE CLAMP



FEATURES

- Zinc plated solid steel
- OXGRIP 'T' bolt/thumb screw
- Thread length 80mm

Product code	Barcode	Size	Inner Qty	Outer Qty
OX-P101716	9341231022180	150mm	4	12

PRO INTERNAL PROFILE CLAMP



FEATURES

- Zinc plated solid steel
- New 'thread insert' threading system
- OXGRIP 'T' bolt/thumb screw
- Throw 0-250mm / Clamp Size 13mm

Product code	Barcode	Size	Inner Qty	Outer Qty
OX-P101140	9328217006099	40 x 40mm	4	12

PRO SLIDING PROFILE CLAMP



FEATURES

- Zinc plated solid steel
- 'T' bolt/thumb screw
- Thread length 80mm

Product code	Barcode	Size	Inner Qty	Outer Qty
OX-P101213	9341231021527	330mm	4	12
OX-P101222	9341231021534	560mm	4	12
OX-P109901	9341231022203	Replacement arm for OX-P101213 & OX-P101222	4	12



PRO DOOR GAUGE

FEATURES

- Zinc plated solid steel
- OXGRIP 'T' bolt/thumb screw
- 'Eastern States' Style Door Frames



Product code	Barcode	Clamping Size	Inner Qty	Outer Qty
OX-P100801	9341231022234	70 x 20mm	4	12

PRO DORI BLOCK

FEATURES

- Genuine replacement part
- Zinc plated solid steel
- 'T' bolt/thumb screw. Can be clamped to the profile pole from either side
- Use with 40 & 50mm profile poles



Product code	Barcode	Internal Size	Inner Qty	Outer Qty
OX-P100950	9341231022241	50 x 50mm	4	12

PRO TOP STEADY NAIL-ON (VENEER) CLAMP SET

FEATURES

Bar & Clamp Set

- Zinc plated solid steel
- OXGRIP 'T' bolt/thumb screw
- New improved clamping system



Product code	Barcode	Description	Inner Qty	Outer Qty
OX-P101002	9341231021503	4 Piece Bar & Clamp Set	4	12

PRO TOP STEADY CLAMP-ON (FULL BRICK) CLAMP SET

FEATURES

Bar & Clamp Set

- Zinc plated solid steel
- OXGRIP 'T' bolt/thumb screw
- New improved clamping system



Product code	Barcode	Description	Inner Qty	Outer Qty
OX-P101001	9341231022258	4 Piece Bar & Clamp Set	4	12



Bricklaying Tools

PRO TOP STEADY BAR



FEATURES

- Zinc plated
- Suits OX-P101001 or OX-P101002

Product code	Barcode	Size	Inner Qty	Outer Qty
OX-P101080	9341231021510	300 x 800mm	4	12

PRO BRICKLAYERS CLAMP



FEATURES

- Ideal for clamping profiles through double brick perps/coarsing

Product code	Barcode	Size	Inner Qty	Outer Qty
OX-P200312	9341231015533	50 x 300mm	1	40

PRO HEAVY DUTY PROFILE POLE



FEATURES

- Durable galvanised steel
- Fine precise lines
- Reversible, two-sided markings
- Professionally marked with the latest technology automatic machine
- Profile size 40 x 40mm
- Number of courses 33

Product code	Barcode	Size	Inner Qty	Outer Qty
OX-P102432	9341231034060	2.83m	12	48



PRO PROFILE PROP

FEATURES

- Professional quality
- Steel heavy duty wing bolt
- High adjustable telescopic arm
- Galvanised steel construction
- Suits OX-P102432 (2 props per profile pole often used)

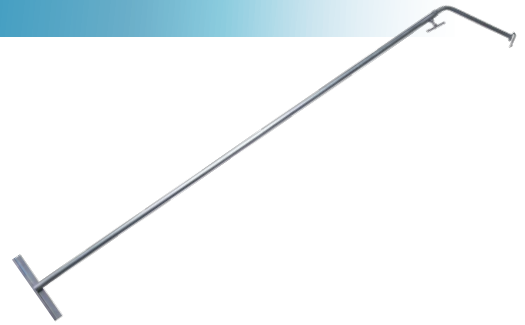

Product code	Barcode	Size	Inner Qty	Outer Qty
OX-P100501	9341231022289	-	12	48

PRO BRICK CARRIER

FEATURES

- OXGRIP handle
- Adjustable
- Heavy duty construction
- Holds 8 - 12 bricks
- Lift Capacity 45kg



Product code	Barcode	Jaw Capacity	Inner Qty	Outer Qty
OX-P170350	9341231020254	400 - 500mm	4	12

PRO LIMESTONE BLOCK CARRIER

FEATURES

- Ergonomic Rubber Hand Grip
- Adjustable Spacings to Suit Different Block Sizes
- Lugs for Extra Grip



Product code	Barcode	Jaw Capacity	Inner Qty	Outer Qty
OX-P170701	9341231014635	500mm	4	8



Bricklaying Tools

PRO BRICK SPLITTER

FEATURES

- Convenient carry handle
- Single motion breaking action
- Auto levelling blade
- Single point fine adjustment
- Quick change, coarse adjustment pin
- Adjustable integral length stop gauge
- Three sided hard wearing replaceable blades
- Spring loaded support arms

Product code	Barcode	Size	Inner Qty	Outer Qty
OX-P190212	9341231022296	-	3	6

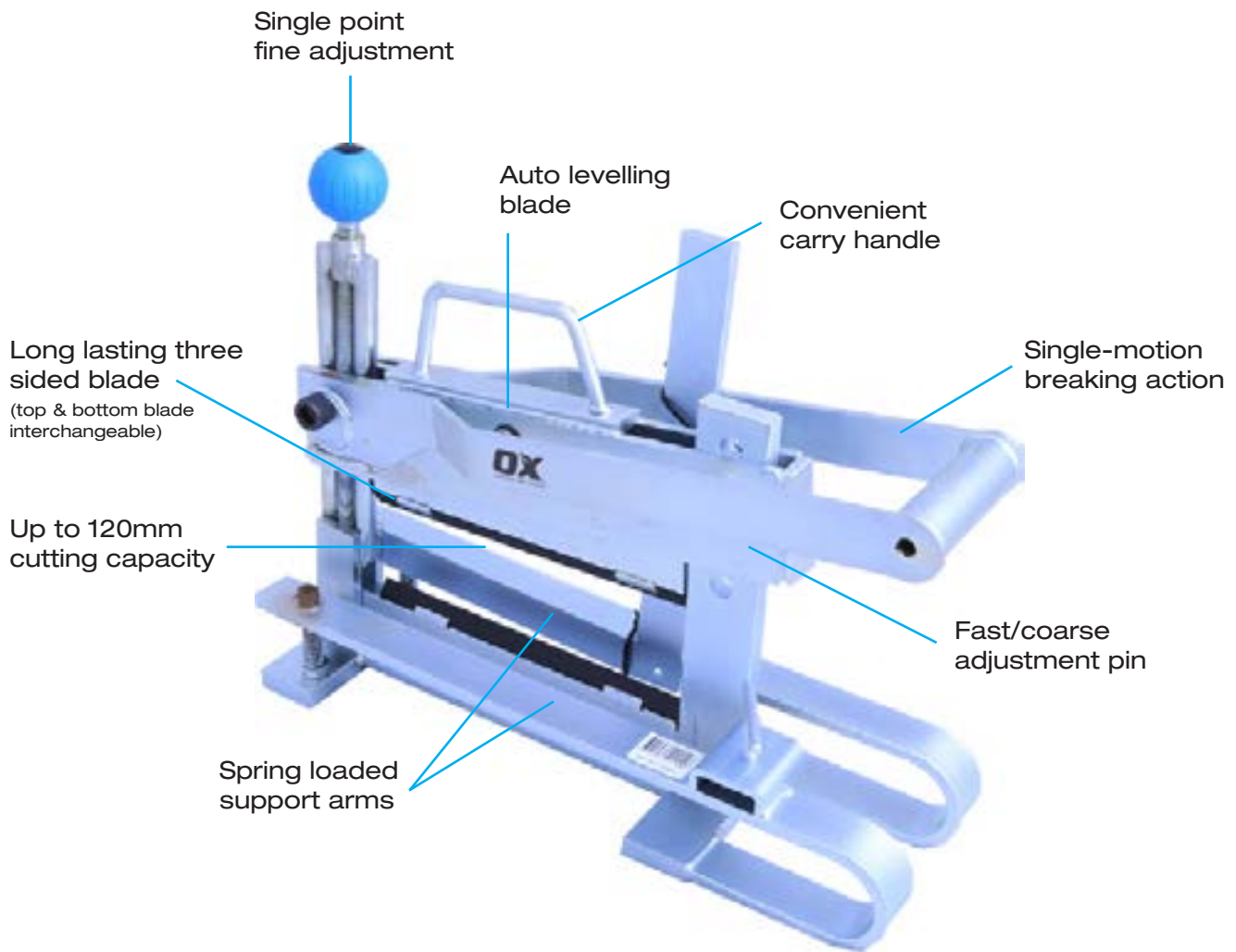



TRADE SCRUB BRUSH – TIMBER STOCK

FEATURES

- Quality smooth timber block
- Yellow crimped poly bristles

Product code	Barcode	Bristle Area	Inner Qty	Outer Qty
OX-T061001	9341231022449	65 x 190mm	6	24



TRADE BANNISTER BRUSH - COCO FIBRE

FEATURES

- Quality smooth timber block
- Black dyed coco fibre bristles

Product code	Barcode	Bristle Area	Inner Qty	Outer Qty
OX-T060401	9341231011894	35 x 135mm	6	24



TRADE BRICKIES BRUSH – DYED COCO FIBRE

FEATURES

- Quality smooth timber block
- Black dyed coco fibre bristles

Product code	Barcode	Bristle Area	Inner Qty	Outer Qty
OX-T060701	9341231022463	70 x 300mm	6	24



TRADE BRICKIES BRUSH – POLY FIBRE

FEATURES

- Quality smooth timber block
- Black poly fibre bristles

Product code	Barcode	Bristle Area	Inner Qty	Outer Qty
OX-T060601	9341231022456	70 x 300mm	6	24



PRO ACID BRUSH

FEATURES

- Heavily filled tampico fibre
- Bristles set securely into hardwood block

Product code	Barcode	Bristle Area	Inner Qty	Outer Qty
OX-P060207	9341231023323	72 x 210mm	4	12





Plastering & Rendering Tools

No trades are as demanding on the design of its tools as the plastering & rendering trade.

Many tools look the same, but the OX Range has been tried and tested by tradesmen and offers unmatched quality.

OX tools do what you want them to do, over and over again.

A tough, durable design for the professional plasterer – you'll probably wear out before they do!





PRO SCORE & SNAP KNIFE

FEATURES

- All steel
- Chrome plated
- Double sided tungsten tipped

Product code	Barcode	Length	Inner Qty	Outer Qty
OX-P220102	9341231011764	220mm	4	12



PRO SMALL TOOL

FEATURES

- One piece solid drop forged from high quality carbon steel
- Precision taper ground and tempered

Product code	Barcode	Width	Inner Qty	Outer Qty
OX-P010113	5060242330452	13mm	4	12
OX-P010116	5060242330469	16mm	4	12
OX-P010119	5060242330476	19mm	4	12
OX-P010125	5060242330483	25mm	4	12



PRO INTERNAL CORNER TROWEL

FEATURES

- OXGRIP handle
- Sturdy aluminium shank with strong mounting
- High quality stainless steel blade - will flex to form perfect 90° corners

Product code	Barcode	Size	Inner Qty	Outer Qty
OX-P013001	5060242330490	102 x 127mm	4	12



PRO JOINT KNIFE

FEATURES

- Full length tang-blade continues through handle to a built-in hammer end
- Ergonomic OXGRIP handle
- High quality flexible stainless steel blade

Product code	Barcode	Square End Width	Inner Qty	Outer Qty
OX-P013203	5060242330438	32mm	4	12
OX-P013205	5060242330421	50mm	4	12
OX-P013207	5060242330414	76mm	4	12
OX-P013210	5060242330407	102mm	4	12
OX-P013212	5060242330391	127mm	4	12
OX-P013215	5060242330384	152mm	4	12





Plastering & Rendering Tools

PRO TAPING KNIFE



FEATURES

- Strong aluminium back
- Ergonomic OXGRIP handle
- High quality flexible stainless steel blade

Product code	Barcode	Square End Width	Inner Qty	Outer Qty
OX-P013320	9341231001192	200mm	4	12
OX-P013325	9341231010781	250mm	4	12
OX-P013330	9341231010798	300mm	4	12

PRO SMALL INTERNAL CORNER TROWEL

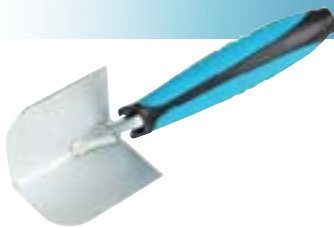

FEATURES

- Sharp 90° Blade
- Ideal for finishing hard-wall plaster

Product code	Barcode	Size	Inner Qty	Outer Qty
OX-P408205	9341231015502	50 x 70mm	6	48

PRO EXTERNAL CORNER TROWEL - SMALL



FEATURES

- Stainless steel blade
- Ergonomic handle
- Blade angle 90° / blade radius 5r

Product code	Barcode	Blade Size	Inner Qty	Outer Qty
OX-P015305	9341231021251	26 x 65mm	4	12

PRO EXTERNAL CORNER TROWEL - MEDIUM



FEATURES

- Stainless steel blade
- Ergonomic handle
- Blade angle 90° / blade radius 8r

Product code	Barcode	Blade Size	Inner Qty	Outer Qty
OX-P015408	9341231021268	40 x 65mm	4	12

PRO EXTERNAL CORNER TROWEL - LARGE



FEATURES

- Stainless steel blade
- Ergonomic handle
- Blade angle 90° / blade radius 5r (OX-P015505)
- Blade angle 90° / blade radius 8r (OX-P015508)

Product code	Barcode	Size	Inner Qty	Outer Qty
OX-P015505	9341231021275	55 x 65mm	4	12
OX-P015508	9328217001070	55 x 65mm	4	12



PRO CORNER TROWEL

FEATURES

- Stainless steel blade
- Ergonomic handle
- Blade angle 90° / blade radius 4r (OX-P015204)
- Blade angle 90° / blade radius 6r (OX-P015206)



Product code	Barcode	Size	Inner Qty	Outer Qty
OX-P015204	9341231021220	33 x 180mm	4	48
OX-P015206	9341231021237	45 x 180mm	4	36

PRO ULTRAFLEX FINISHING TROWEL

FEATURES

- New ultra flexible trowel for a perfect finish
- Lightweight fully fastened shank for superior balance and strength
- Unique twin blade technology for ultimate flexibility
- 0.3mm Ultra flexible stainless steel blade
- Rounded corners to ensure a smooth finish
- Ergonomic soft grip handle



Product code	Barcode	Size	Inner Qty	Outer Qty
OX-P530111	5060359916310	11" / 280 x 110mm	N/A	1
OX-P530114	5060359916327	14" / 355 x 110mm	N/A	1

Lightweight fully fastened shank for superior balance and strength

Ergonomic soft grip handle

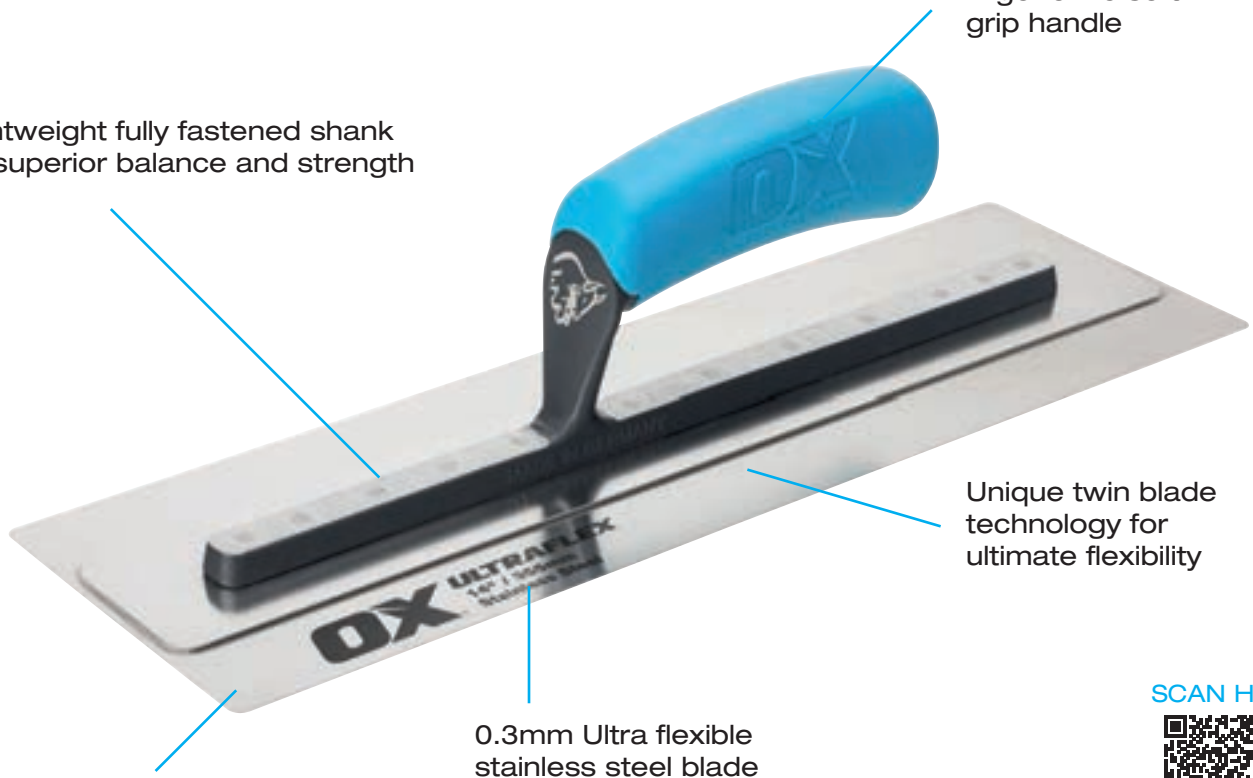

Unique twin blade technology for ultimate flexibility

0.3mm Ultra flexible stainless steel blade

Rounded corners to ensure smooth finish

SCAN HERE





Plastering & Dry Lining Tools

PRO SPEEDSKIM – ST (PLASTERING & RENDERING)

FEATURES

- Speedskim® is the new and revolutionary tool system designed to increase metrage output and enhance quality of finish – at the same time significantly reducing the harmful effects of fatigue & RSI
- Flattening, finishing & ruling off
- Compatible with all gypsum based plasters (hand and spray applied), Traditional sand & cement renders and insulated rendering systems
- Complete with integral blade guard



Product Code	Barcode	Size	Inner Qty	Outer Qty
OX-P530945	5060359919243	450mm	1	14
OX-P530960	5060359919250	600mm	1	14
OX-P530990	5060359919267	900mm	1	14
OX-P530912	5060359919274	1200mm	1	14
OX-P530918	5060359919281	1800mm	1	4

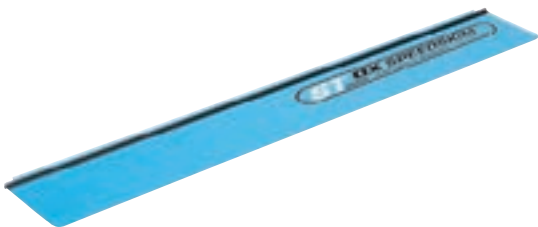

Replacement blade

- Complete with integral blade guard and spare end caps

Product Code	Barcode	Size	Inner Qty	Outer Qty
OX-P531245	5060359919373	450mm	1	4
OX-P531260	5060359919380	600mm	1	4
OX-P531290	5060359919397	900mm	1	4
OX-P531212	5060359919403	1200mm	1	4
OX-P531218	5060359919410	1800mm	1	4

PRO SPEEDSKIM – POLE ATTACHMENT

FEATURES

- Fully compatible with all standard professional 'threaded' extension poles
- Constructed from 'tough glass filled' nylon
- Compatible with all sizes of Speedskim



Product Code	Barcode	Size	Inner Qty	Outer Qty
OX-P531501	5060359919502	-	1	32



PRO SPEEDSKIM – SF (FINE FINISHING & DRYWALL)

FEATURES

- Speedskim® is the new and revolutionary tool system designed to increase metreage output and enhance quality of finish – at the same time significantly reducing the harmful effects of fatigue & RSI
- Ultra-fine 0.3mm stainless steel blade
- Fine finishing of plaster, drywall & tape & jointing
- Compatible with all gypsum based finishing plasters (hand and spray applied), Jointing systems and compounds
- Complete with integral blade guard



Product Code	Barcode	Size	Inner Qty	Outer Qty
OX-P531045	5060359919304	450mm	1	14
OX-P531060	5060359919311	600mm	1	14
OX-P531090	5060359919328	900mm	1	14
OX-P531012	5060359919335	1200mm	1	14

Replacement blade

- Complete with integral blade guard and spare end caps

Product Code	Barcode	Size	Inner Qty	Outer Qty
OX-P531345	5060359919434	450mm	1	4
OX-P531360	5060359919441	600mm	1	4
OX-P531390	5060359919458	900mm	1	4
OX-P531312	5060359919465	1200mm	1	4

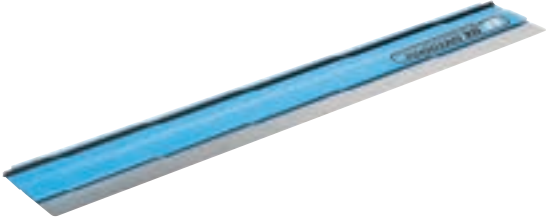

UK Professional Builder Magazine

Covered by world patents, registered designs & pending applications.



Plastering & Rendering Tools

PRO WOODEN MITRE BOX



FEATURES

- Laminated plywood
- Durable construction
- Professional quality
- Angle size: 45°
- Suits: 55mm, 75mm & 90mm cornice

Product code	Barcode	Internal Size	Inner Qty	Outer Qty
OX-P023201	9341231013027	90 x 295mm	4	12

PRO PLASTERER'S SQUARE



FEATURES

- Stainless steel
- Fully adjustable for precise bevels
- Adjustable wing nuts for setting desired internal and external angles

Product code	Barcode	Internal Size	Inner Qty	Outer Qty
OX-P020201	9341231022616	210 x 210 x 300mm	6	36

PRO PLASTER SCOOP



FEATURES

- OXGRIP handle
- Heavy duty galvanized pan - for longevity
- Bracket hang hook - for putting on the side of a bucket

Product code	Barcode	Size	Inner Qty	Outer Qty
OX-P010718	9341231011368	180mm	4	12



TRADE PLASTER SCOOP

FEATURES

- Economical plastic construction
- Sturdy grip to withstand heavy loads
- Lightweight
- Made in Europe

Product code	Barcode	Size	Inner Qty	Outer Qty
OX-T530217	9341231016028	180mm	1	30



TRADE ALUMINIUM HAWK

FEATURES

- OXGRIP handle
- High quality, lightweight and tempered aluminium blade mounted with 6 rivets for extra strength

Product code	Barcode	Size	Inner Qty	Outer Qty
OX-T010513	9341231038242	330 x 330mm	4	12



PRO ALUMINIUM HAWK

FEATURES

- OXGRIP handle
- High quality, lightweight and tempered aluminium blade mounted with 8 rivets for extra strength
- Surface of blade machined to prevent mortar from sliding off and aluminium from bowing or bending

Product code	Barcode	Size	Inner Qty	Outer Qty
OX-P010512	9341231010811	300 x 300mm	4	12
OX-P010513	5060242330377	330 x 330mm	4	12



PRO SQUARE FRONT TROWEL

FEATURES

- OXGRIP handle with finger protection
- High quality carbon steel
- Heavy duty straight shank
- Soft grip handle for extreme comfort

Product code	Barcode	Size	Inner Qty	Outer Qty
OX-P013718	5060242330506	7" / 180mm	4	12
OX-P013720	9341231022517	7 7/8" / 200mm	4	12





Plastering & Rendering Tools

TRADE POLYURETHANE FLOAT



FEATURES

- One piece moulded
- Lightweight

Product code	Barcode	Size	Inner Qty	Outer Qty
OX-T010212	9341231011917	120 x 240mm	4	12
OX-T010214	9341231011924	140 x 280mm	4	12
OX-T010218	9341231011931	180 x 320mm	4	12
OX-T010220	9341231011948	200 x 360mm	4	12

PRO RECTANGULAR POLYURETHANE FLOAT



FEATURES

- High quality polyurethane
- One piece moulded
- Made in the EU

Product code	Barcode	Size	Inner Qty	Outer Qty
OX-P010212	9341231001819	120 x 240mm	4	12
OX-P010214	9341231001826	140 x 280mm	4	12
OX-P010218	9341231001833	180 x 320mm	4	12
OX-P010220	9341231001840	200 x 360mm	4	12
OX-P010222	9341231001857	220 x 420mm	4	12

PRO ANGULAR POLYURETHANE FLOAT



FEATURES

- High quality polyurethane
- One piece moulded
- Made in the EU

Product code	Barcode	Size	Inner Qty	Outer Qty
OX-P010208	9341231001802	80 x 260mm	4	12

PRO RECTANGULAR PLASTIC FLOAT



FEATURES

- High strength ABS plastic
- Diamond patterned base

Product code	Barcode	Size	Inner Qty	Outer Qty
OX-P012127	9341231001796	180 x 270mm	4	12
OX-P012144	9341231022647	140 x 440mm	4	12
OX-P012135	9341231010767	270 x 350mm	4	12
OX-P012142	9341231022654	260 x 420mm	4	12



PRO POINTED PLASTIC FLOAT

FEATURES

- High strength ABS plastic
- Diamond patterned base

Product code	Barcode	Size	Inner Qty	Outer Qty
OX-P012027	9341231022630	140 x 270mm	4	12

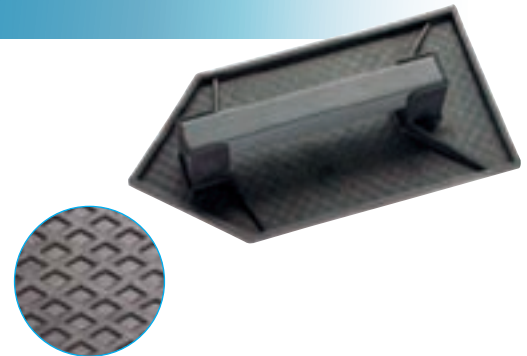

PRO CLEAR TEXTURE FINISHING TROWEL

FEATURES

- Clear non-marking blade
- Ergonomic handle

Product code	Barcode	Size	Inner Qty	Outer Qty
OX-P011611	9341231001741	130 x 280mm	12	60



TRADE RED TEXTURE FINISHING TROWEL

FEATURES

- Red ABS blade
- Ergonomic handle

Product code	Barcode	Size	Inner Qty	Outer Qty
OX-T010611	9341231016264	130 x 280mm	12	60



PRO RED TEXTURE FINISHING TROWEL

FEATURES

- Red PVC blade
- Ergonomic OXGRIP handle

Product code	Barcode	Size	Inner Qty	Outer Qty
OX-P408511	9341231015847	130 x 280mm	10	40





Plastering & Rendering Tools

TRADE FINISHING TROWEL – TIMBER HANDLE



FEATURES

- Carbon steel blade
- Aluminium shank
- Ergonomic timber handle

Product code	Barcode	Size	Inner Qty	Outer Qty
OX-T017211	9341231036323	115 x 280mm	4	12
OX-T017214	9341231022791	120 x 356mm	4	12

TRADE FINISHING TROWEL – RUBBER HANDLE



FEATURES

- Carbon steel blade
- Aluminium shank
- Ergonomic rubber grip handle

Product code	Barcode	Size	Inner Qty	Outer Qty
OX-T010911	9341231022807	115 x 280mm	4	12
OX-T010914	9341231022814	120 x 356mm	4	12

PRO FINISHING TROWEL

FEATURES

- High quality tempered steel blade
- Lightweight aluminium shank
- Handle position set for perfect balance
- Extended OXGRIP handle designed for increased comfort
- More rivets than any other trowel made
- Cross ground blade - for reduced drag and quicker break-in time



CARBON STEEL

CARBON STEEL

Product code	Barcode	Size	Inner Qty	Outer Qty
OX-P010995	9341231021121	100 x 240mm	4	12
OX-P010911	9341231021084	120 x 280mm	4	12
OX-P010914	9341231021091	120 x 356mm	4	12
OX-P010916	9341231021107	100 x 406mm	4	12
OX-P010918	9341231021114	115 x 457mm	4	12

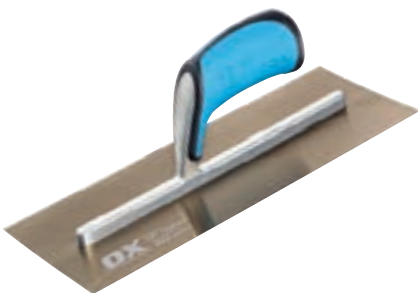

STAINLESS STEEL

STAINLESS STEEL

Product code	Barcode	Size	Inner Qty	Outer Qty
OX-P011008	9341231021138	75 x 200mm	4	12
OX-P011095	9341231021183	100 x 240mm	4	12
OX-P011011	9341231021145	120 x 280mm	4	12
OX-P011014	9341231021152	120 x 356mm	4	12
OX-P011018	9341231021176	115 x 457mm	4	12



PRO RECTANGULAR POLYSTYRENE FLOAT

FEATURES

- High quality polystyrene
- One piece moulded

Product code	Barcode	Size	Inner Qty	Outer Qty
OX-P012814	9341231020308	140 x 260mm	4	12
OX-P012818	9341231020315	180 x 320mm	4	12



PRO BOAT SHAPED POLYSTYRENE FLOAT

FEATURES

- High quality polystyrene
- One piece moulded

Product code	Barcode	Size	Inner Qty	Outer Qty
OX-P012718	9341231020292	205 x 350mm	4	12



PRO PERFORATED SPONGE FLOAT

FEATURES

- Zinc plated perforated blade - easy to clean
- Special "fine cell" sponge
- OXGRIP handle

Product code	Barcode	Size	Inner Qty	Outer Qty
OX-P010830	9341231020339	130 x 300mm	4	12

- Replacement sponge
- Special sponge compound - designed for render
- 6 sponges per pack

Product code	Barcode	Size	Inner Qty	Outer Qty
OX-P019813	9341231022708	130 x 300mm	6	24



PRO PS RUBBER SPONGE FLOAT

FEATURES

- One piece moulded handle + blade
- Soft - Long life "sponge-rubber" material
- Made in the EU

Product code	Barcode	Size	Inner Qty	Outer Qty
OX-P014014	9341231010316	140 x 280mm	4	12

- Replacement sponge
- Pre-glued for convenience

Product code	Barcode	Size	Inner Qty	Outer Qty
OX-P019914	9341231001888	140 x 280mm	6	24





Plastering & Rendering Tools

PRO YELLOW SPONGE FLOAT



FEATURES

- Ideal for sandy surfaces
- Fine cell foam pad specially bonded to an aluminium backing plate
- 1" thick foam sponge
- OXGRIP handle

Product code	Barcode	Size	Inner Qty	Outer Qty
OX-P402414	9341231032622	140 x 280mm	4	12

- Replacement sponge
- 6 sponges per pack

Product code	Barcode	Size	Inner Qty	Outer Qty
OX-P402514	9341231032639	140 x 280mm	6	12

TRADE WEEPHOLE CLEANER



FEATURES

- Stainless steel
- Bottle opener hole – for convenience
- Template for accurate weephole

Product code	Barcode	Size	Inner Qty	Outer Qty
OX-T030401	9341231001277	75 & 50mm	3	6

PRO MASONRY WATER BRUSH



FEATURES

- White tampico fibre bristles
- Bristles set securely into hardwood block
- Handle pinned and glued for secure attachment
- Made in the U.S.A

Product code	Barcode	Bristles	Inner Qty	Outer Qty
OX-P060105	9341231013485	5 Rows	4	12

TRADE WATER BRUSH



FEATURES

- Quality smooth timber block
- White coco fibre bristles
- Two knot

Product code	Barcode	Bristle Area	Inner Qty	Outer Qty
OX-T060802	9341231011900	120 x 60 x 150mm	6	24



TRADE ACID BRUSH

FEATURES

- Quality smooth timber block
- White coco fibre bristles



Product code	Barcode	Bristle Area	Inner Qty	Outer Qty
OX-T060801	9341231022821	50mm	6	24

TRADE TYROLEAN SPLATTER MACHINE

FEATURES

- Brass plated design
- Removable cover for easy access
- Ergonomic plastic handle
- Adjustable tension rod



Product code	Barcode	Size	Inner Qty	Outer Qty
OX-T044501	9341231031175	-	6	18

TRADE TEXTURE GUN – SQUARE

FEATURES

- Ideal for applying masonry coatings - cement render, and concrete re-surfacing products
- With airflow regulator and 45° elbow
- Operating pressure bar 3.0-4.0
- Air volume usage 0.623 CBM / min



Product code	Barcode	Size	Inner Qty	Outer Qty
OX-T040308	9341231013607	8L	4	12

TRADE TEXTURE GUN - REPLACEMENT NOZZLES

FEATURES

- Genuine OX parts



Product code	Barcode	Size	Inner Qty	Outer Qty
OX-P049703	9341231021886	4mm	3	6
OX-P049704	9341231021893	6mm	3	6
OX-P049705	9341231021909	8mm	3	6



Plastering & Rendering Tools

TRADE TEXTURE GUN - SPARE PARTS

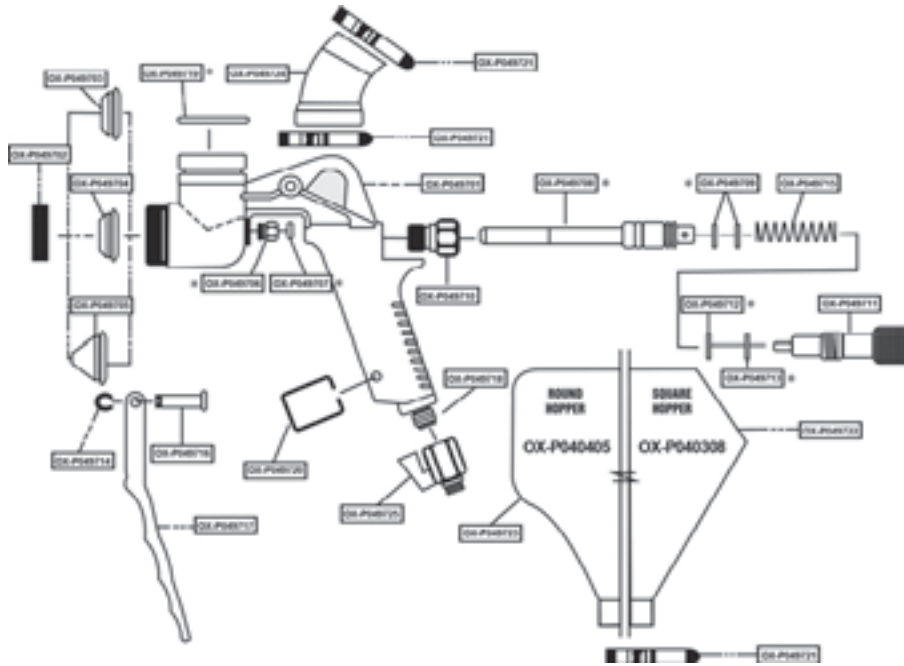

Product code	Descriptions	Replacements Parts Kits
OX-P049701	Aluminum Body	Part NO: OX-P049799
OX-P049702	Retaining Ring	Contents:
OX-P049703	4.0mm Nozzle	*1 x Fitting OX-P049706
OX-P049704	6.0mm Nozzle	*1 x O-Ring OX-P049707
OX-P049705	8.0mm Nozzle	*1 x Needle Shaft OX-P049709
OX-P049706	Fitting	*2 x O-Ring OX-P049712
OX-P049707	O-Ring	*1 x Gasket OX-P049713
OX-P049708	Needle Shaft	*1 x O-Ring
OX-P049709	O-Ring	*1 x O-Ring
OX-P049710	Regulator Guide	
OX-P049711	Assembly	
OX-P049712	Gasket	
OX-P049713	O-Ring	
OX-P049714	E-Ring	
OX-P049715	Spring	
OX-P049716	Pin	
OX-P049717	Trigger	
OX-P049718	Connection	
OX-P049719	O-Ring	
OX-P049720	Clip Ring	
OX-P049721	Clamp	
OX-P049722	Plastic Hopper-Square	
OX-P049723	Plastic Hopper-Round	
OX-P049724	45° Elbow	
OX-P049725	On/Off Valve	

FEATURES

- The 4.0mm & 6.0mm nozzles are suitable for medium viscosity materials
- The 8.0mm nozzle is suitable for high viscosity materials
- The size of drop is controlled by means of the air regulator which can be fitted in the air inlet in the gun body
- The spray gun is an internal mix type with material gravity fed from the hopper
- This gun requires a minimum of an 8mm hose line
- Maximum hopper capacity is 5.5 litres - square or 3.5 litres - round
- Use with masonry, textured paints & textile wall coatings on medium sizes surfaces

TRADE TEXTURE GUN - REPLACEMENT KIT



FEATURES

- Genuine OX parts
- Parts kit include parts marked with*

Product code	Barcode	Suits	Inner Qty	Outer Qty
OX-P049799	9341231021916	OX-T040308	3	6



PRO 1400W MIXING DRILL

FEATURES

- Powerful constant speed control
- Splash free electronics soft start
- Variable electronic speed control dial
- Easily accessible replacement carbon brushes
- High torque two speed gear box
- Ergonomically shaped OXGRIP handle
- Durable protective rubber housing protectors
- Suitable for mixing cementitious material and non-flammable liquids
- Includes Ø140 x 600mm Mixing Paddle



Product code	Barcode	Description	Inner Qty	Outer Qty
OX-P284	9341231017490	160mm Mixing Paddle Wrench, Carrying Case	3	6

TECHNICAL INFORMATION

Input Power	1400W
No Load Speed Gear 1	150-300RPM
No Load Speed Gear 2	300-650RPM
Spindle	M14
Weight	15kg



Plastering & Rendering Tools

TRADE MIXING PADDLE – HELICAL WITH RIM

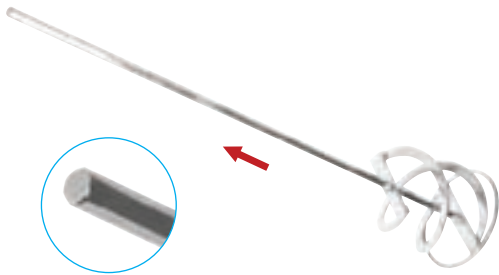

FEATURES

- Zinc plated
- For mixing tile glue, grout etc. - use on high viscosity materials

Product code	Barcode	Drive HEX-mm (Male)	Batch Size kg	Size mm	Inner Qty	Outer Qty
OX-T120609	9341231015922	8	5 - 15	90 x 500	4	12
OX-T120612	9341231015939	10	20 - 30	120 x 600	4	12

TRADE MIXING PADDLE – NEGATIVE HELIX

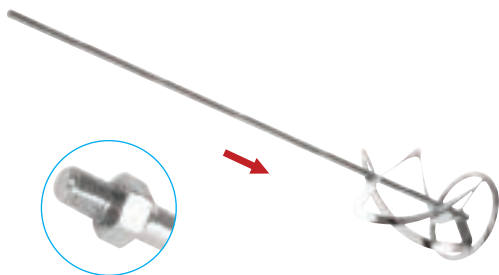

FEATURES

- Zinc plated
- For mixing acrylic render with grit, thick paint etc. - use on medium viscosity materials

Product code	Barcode	Drive	Batch Size kg	Size mm	Inner Qty	Outer Qty
OX-T120435	9341231015915	M14	25-40	135 x 650	4	12

PRO MIXING PADDLE – RIBBON

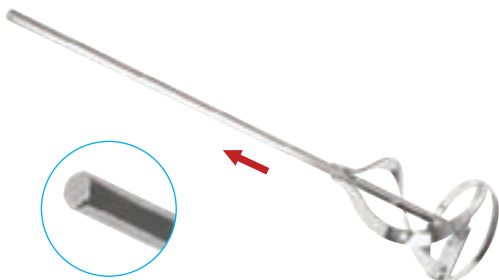

FEATURES

- Chrome plated
- For mixing paint and general liquids - low to medium viscosity materials

Product code	Barcode	Drive HEX-mm (Male)	Batch Size kg	Size mm	Inner Qty	Outer Qty
OX-P120308	9328217002534	8	5 - 10	80 x 400	4	12

PRO MIXING PADDLE - DUAL FIN

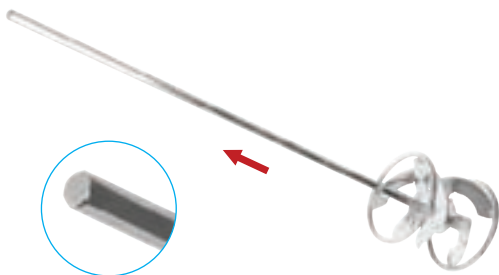

FEATURES

- Chrome plated
- For mixing paint, tile glue, grout etc. - multi-purpose use on low to high viscosity materials

Product code	Barcode	Drive HEX-mm (Male)	Batch Size kg	Size mm	Inner Qty	Outer Qty
OX-P120809	9341231010927	8	5 - 15	85 x 500	4	12



PRO MIXING PADDLE – HELICAL WITH RIM

FEATURES

- Chrome plated
- For mixing tile glue, grout etc. - use on high viscosity materials

Product code	Barcode	Drive HEX-mm (Male)	Batch Size kg	Size mm	Inner Qty	Outer Qty
OX-P120609	9341231010897	8	5 - 15	90 x 500	4	12
OX-P120612	9341231010903	10	20 - -30	120 x 600	4	12

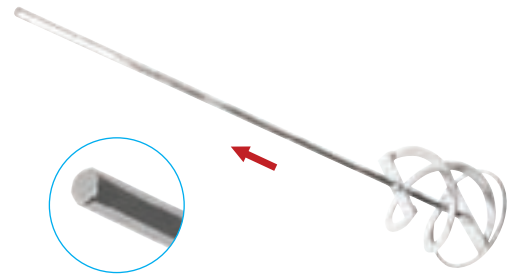

PRO MIXING PADDLE – HELICAL WITH RIM

FEATURES

- Chrome plated
- For mixing tile glue, grout etc. - use on high viscosity materials

Product code	Barcode	Drive	Batch Size kg	Size mm	Inner Qty	Outer Qty
OX-P121035	9341231010965				6	18

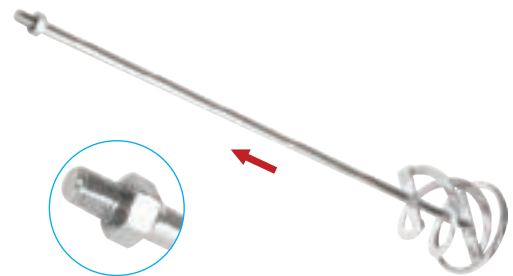

IDEAL FOR TILING

PRO MIXING PADDLE – NEGATIVE HELIX

FEATURES

- Chrome plated
- For mixing acrylic render without grit, paint, epoxy etc.
- use on low viscosity materials

Product code	Barcode	Drive HEX-mm (Male)	Batch Size kg	Size mm	Inner Qty	Outer Qty
OX-P120735	9341231010910	12	25-40	135 x 750	4	12

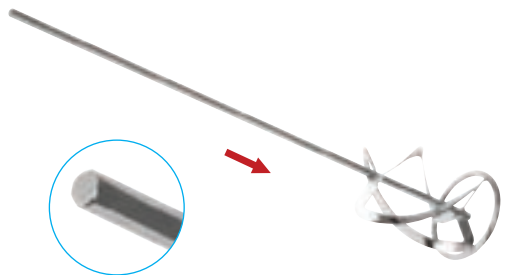



Plastering & Rendering Tools

PRO MIXING PADDLE – POSITIVE HELIX

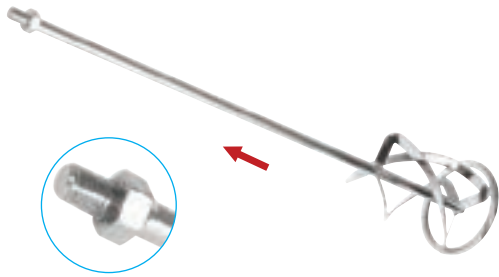

FEATURES

- Chrome plated
- For mixing acrylic render without grit, thick paint - use on high viscosity materials

Product code	Barcode	Drive	Batch Size kg	Size mm	Inner Qty	Outer Qty
OX-P120535	9341231010880	M14	25-40	135 x 650	4	12

PRO MIXING PADDLE – NEGATIVE HELIX

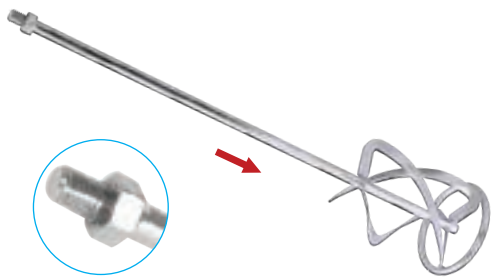

FEATURES

- Chrome plated
- For mixing acrylic render with grit, thick paint etc. - use on medium viscosity materials

Product code	Barcode	Drive	Batch Size kg	Size mm	Inner Qty	Outer Qty
OX-P120435	9341231010866	M14	25-40	135 x 650	4	12

PRO HEAVY DUTY STIRRER

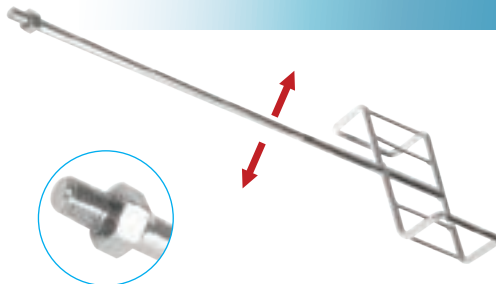

FEATURES

- Chrome plated
- For mixing lime putty plaster

Product code	Barcode	Drive	Batch Size kg	Size mm	Inner Qty	Outer Qty
OX-P120220	9341231010835	M14	55 - 70	200 x 650	4	12

IDEAL FOR TEXTURE COATING

PRO ADAPTOR



- Chrome plated
- For increasing the length of M14 drive shaft

Product code	Barcode	Drive	Length mm	Inner Qty	Outer Qty
OX-P121515	9341231011016	M14	150	3	6

PRO MIXING DRILL ADAPTOR - HEX/M14(F)



- Chrome plated
- For turning M14 thread into 10mm hex

Product code	Barcode	Description	Inner Qty	Outer Qty
OX-P121801	9341231038013	OX Pro Mixing Drill Adaptor - Hex/M14(F)	4	8



PRO MixM8 MIXING PADDLES – HEX / M14

FEATURES

- **GUARANTEED** – Faster mix even using a cordless drill (min 18V)
- **GUARANTEED** – Less effort and smoother final mix
- Long life and easy clean
- Edge to edge mixing - no need to stop and stir
- 10mm Shaft version fits a standard chuck and can be used with a standard 18v cordless drill - no need for power on site when mixing
- Far less strenuous - no more chasing your mix around, just hold the MixM8 in the centre of the bucket and let the blades do the work

Product code	Barcode	Size	Inner Qty	Outer Qty
OX-P121910	5060359915443	10mm Hex	N/A	6
OX-P122014	5060359915450	14mm M14	N/A	6

INSTRUCTIONS FOR USE

- For best results: use a 25l plastering bucket
- It is essential that the water is put into the bucket before the powder (11.5 litres for a whole 25kg bag of multi-finish plaster).
- Empty the full bag or bags of plastering product into the bucket and allow the mix to settle into the water for a few seconds.
- Once the mixture has settled insert the mixm8 blade tool into the mix and fully immerse the tool in the centre of the bucket.
- Hold the tool vertically and once fully immersed apply the power slowly and once the vortex starts increase to full power.
- Hold the tool vertically in the centre of the bucket and allow the tool to do the work.
- You can lift the tool up and down but you do not have to chase the mix round the bucket as you would do with a conventional mixer.
- No need to stop and scrape the side of the bucket as the mix is pulled in and down, check your mix after 35-40 seconds as it may be ready to apply.
- To clean just run the blade in a bucket of clean water for 3-4 seconds, pull it out and you will have a perfectly clean blade.



SCAN HERE





Tiling Tools

OX tiling tools are designed to meet the high expectations of the professional tiler and clearly carry the quality and design represented by the OX brand.





PRO STRAIGHT SET TILE NIPPER – TWO STRAIGHT

FEATURES

- Strong drop forged body
- Cuts round and irregular shapes
- OXGRIP handles
- Tungsten – solid tip, set in and ground/polished finished

Product code	Barcode	Size	Inner Qty	Outer Qty
OX-P152180	9341231029462	8" / 200mm	2	6



PRO STRAIGHT SET TILE NIPPER – TWO CURVED

FEATURES

- Strong drop forged body
- Cuts round and irregular shapes
- OXGRIP handles
- Tungsten – solid tip, set in and ground/polished finished

Product code	Barcode	Size	Inner Qty	Outer Qty
OX-P152280	9341231029479	8" / 200mm	2	6



PRO OFFSET TILE NIPPER – TWO CURVED

FEATURES

- Strong drop forged body
- Cuts round and irregular shapes
- OXGRIP handles
- Tungsten – solid tip, set in and ground/polished finished

Product code	Barcode	Size	Inner Qty	Outer Qty
OX-P151285	9341231035753	8.5" / 210mm	12	60



PRO OFFSET TILE NIPPER - ONE CURVED / ONE STRAIGHT

FEATURES

- Strong drop forged body
- Cuts round and irregular shapes
- OXGRIP handles
- Tungsten – solid tip, set in and ground/polished finished

Product code	Barcode	Size	Inner Qty	Outer Qty
OX-P151385	9341231029509	8½" / 210mm	2	6





Tiling Tools

PRO TILE SCRIBER



FEATURES

- Tungsten tipped
- Chrome plated

Product code	Barcode	Size	Inner Qty	Outer Qty
OX-P220208	9341231029585	200mm	4	12

PRO PARROT BEAK TILE NIPPER



FEATURES

- Strong drop forged body
- Cuts round and irregular shapes
- OXGRIP handles
- Tungsten – solid tip, set in and ground/polished finished

Product code	Barcode	Size	Inner Qty	Outer Qty
OX-P152475	9341231029516	7/2" / 190mm	2	6

TRADE TRIM /FILLET CUTTER



FEATURES

- Chrome plated
- Integral angle gauge
- Soft moulded hand grips

Product code	Barcode	Size	Inner Qty	Outer Qty
OX-T151010	9341231029523	8" / 216mm	4	12

TRADE CROSS SHAPED TILE SPACERS



FEATURES

- Packet of 250pc
- Perfect consistent spacing
- Easy to use

Product code	Barcode	Size	Inner Qty	Outer Qty
OX-T160903	9341231040290	3mm	4	8



TRADE WEDGE SHAPED TILE SPACERS

FEATURES

- Strong and durable plastic tile wedges
- 500 pcs per bag

Product code	Barcode	Max Size	Inner Qty	Outer Qty
OX-T160605	9341231029264	6mm	25	100

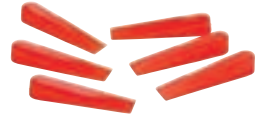

TRADE V NOTCH TROWEL

FEATURES

- Carbon steel blade & timber handle
- Aluminium shank
- Size: 115 x 280mm

Product code	Barcode	V Size	Inner Qty	Outer Qty
OX-T401803	9341231038075	3mm	4	12
OX-T401804	9341231029721	4mm	4	12



TRADE NOTCH TROWEL

FEATURES

- Rubber grip handle
- Carbon steel blade
- Square notches
- Size: 120 x 280mm

Product code	Barcode	Notch Size	Inner Qty	Outer Qty
OX-T403104	9341231040078	4 x 4mm	4	12
OX-T403106	9341231040085	6 x 6mm	4	12
OX-T403108	9341231040092	8 x 8mm	4	12
OX-T403110	9341231040108	10 x 10mm	4	12



PRO NOTCH TROWEL - EXTRA LONG

FEATURES

- Carbon steel blade & aluminium shank
- OXGRIP handle
- Size: 115 x 356mm

Product code	Barcode	Size	Inner Qty	Outer Qty
OX-P407210	9341231038051	10 x 10mm	4	12
OX-P407212	9341231038068	12 x 12mm	4	12

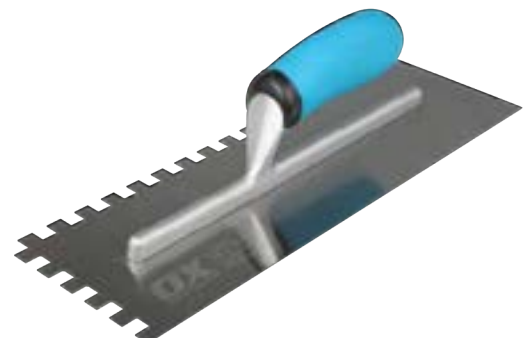



Tiling Tools

PRO NOTCH TROWEL



FEATURES

- Carbon steel blade & aluminium shank
- OXGRIP handle
- Size: 115 x 280mm

Product code	Barcode	Size	Inner Qty	Outer Qty
OX-P013406	9341231024146	6 x 6mm	4	12
OX-P013408	9341231024153	8 x 8mm	4	12
OX-P013410	9341231024160	10 x 10mm	4	12
OX-P013412	9341231024177	12 x 12mm	4	12

PRO GAUGING TROWEL



FEATURES

- Welded shank
- Precision taper ground blade
- OXGRIP handle
- 'S' style shank - will 'hang' on the side of a bucket

Product code	Barcode	Size	Inner Qty	Outer Qty
OX-P011407	5060242330261	3½ x 7" / 88 x 178mm	4	12
OX-P011408	9341231010804	3½ x 8" / 95 x 203mm	4	12

PRO HEART SHAPE TROWEL



FEATURES

- High quality carbon steel
- Heavy duty shank
- OXGRIP handle for extra comfort

Product code	Barcode	Size	Inner Qty	Outer Qty
OX-P013816	9341231029882	115 x 160mm	6	36

PRO GROUT REMOVER



FEATURES

- Tungsten carbide tipped blade
- Ergonomic body and grip - with blade storage compartment in the hilt
- Size: 210mm

Product code	Barcode	Blade Size	Inner Qty	Outer Qty
OX-P130201	9341231027185	50mm	4	16

- Replacement blades
- Tungsten carbide tipped blade
- Suits OX-P130201

Product code	Barcode	Size	Inner Qty	Outer Qty
OX-P139801	9341231029905	50mm	6	36





TRADE WALL SCRAPER

FEATURES

- Strips various product off many surfaces

Product code	Barcode	Blade Size	Inner Qty	Outer Qty
OX-T050604	9341231013980	100mm	4	12
OX-T050606	9341231026010	150mm	4	12

- Replacement blades
- 5 blades per pack

Product code	Barcode	Blade Size	Inner Qty	Outer Qty
OX-T059504	9341231036255	100mm	3	6
OX-T059506	9341231013997	150mm	3	6



PRO HEAVY DUTY SCRAPER

FEATURES

- Chrome plated shaft
- Triple screw blade clamp
- Power weighted OXGRIP end
- Size: 450mm

Product code	Barcode	Blade Size	Inner Qty	Outer Qty
OX-P050105	9341231029912	5" / 127mm	4	12

- Replacement blades - 10pk
- Made from high quality carbon steel
- Suits OX-P050105

Product code	Barcode	Size	Inner Qty	Outer Qty
OX-P059905	9341231029929	127 x 19 x 1mm	6	18



PRO TUNGSTEN CARBIDE GRIT HALF ROUND FILE

FEATURES

- With handle
- Double sided - flat and 1/2 round
- Fine (80 grit)

Product code	Barcode	Blade Size	Inner Qty	Outer Qty
OX-P070455	9341231029561	10" / 250mm	4	12





Tiling Tools

PRO TILERS LEVEL - 2 VIAL

FEATURES

- Magnified centre vial
- Made from structural aircraft alloy
- Plexiglass shock proof vials
- Accuracy +/- 0.5mm/m

Product code	Barcode	Length	Inner Qty	Outer Qty
OX-P021203	9341231030031	300mm	3	6
OX-P021204	9341231030046	400mm	3	6
OX-P021206	9341231030055	600mm	3	6
OX-P021208	9341231030062	800mm	3	6
OX-P021210	9341231030079	1000mm	3	6

PRO TILERS LEVEL - 3 VIAL

FEATURES

- Magnified centre vial
- Made from structural aircraft alloy
- Plexiglass shock proof vials
- Accuracy +/- 0.5mm/m

Product code	Barcode	Length	Inner Qty	Outer Qty
OX-P023110	9341231030086	1000mm	3	6
OX-P023112	9341231030093	1200mm	3	6
OX-P023115	9341231030109	1500mm	3	6
OX-P023118	9341231030116	1800mm	3	6
OX-P023120	9341231030123	2000mm	3	6

PRO 7 PIECE TILERS SET – COMPLETE TILERS LEVEL SET

FEATURES

- Magnified centre vial
- Made from structural aircraft alloy
- Plexiglass shock proof vials
- Accuracy +/- 0.5mm/m
- 2 Vials: 300mm x 1, 400mm x 1, 600mm x 1, 800mm x 1, 1000mm x 1
- 3 Vials: 1200mm x 1, 2000mm x 1

Product code	Barcode	Content	Inner Qty	Outer Qty
OX-P21SET7	9341231034152	7 pieces	4	8



PRO SINGLE CUP RUBBER SUCTION LIFTER

FEATURES

- Easy single handed use
- Grips on to any smooth flat surface
- Easy to use - press-on for suction - lift lipped edge for release
- Max lift capacity 20kg



Product code	Barcode	Cup Size	Inner Qty	Outer Qty
OX-P170403	9341231026041	3" / 80mm	4	8

PRO SINGLE CUP SUCTION LIFTER

FEATURES

- Heavy duty design – ergonomic aluminium 'D' grip
- Grips on to any smooth flat surface
- Easy to use - press-on for suction - lift 'T' release valve to let go
- Max lift capacity 25kg



Product code	Barcode	Cup Size	Inner Qty	Outer Qty
OX-P170504	9341231029950	5" / 125mm	2	6

PRO DOUBLE CUP SUCTION LIFTER

FEATURES

- Ergonomic aluminium handle bar
- Grips on to any smooth flat surface
- Quick action – suction 'ON/OFF' levers
- Max lift capacity 35kg



Product code	Barcode	Size	Inner Qty	Outer Qty
OX-P170524	9341231029967	4½" / 115mm	2	6

PRO TRIPLE CUP SUCTION LIFTER

FEATURES

- Aluminium grip & body
- Rigid triple head design
- Grips on to any smooth flat surface
- Quick action - suction 'ON/OFF' levers
- Max lift capacity 100kg



Product code	Barcode	Size	Inner Qty	Outer Qty
OX-P170534	9341231029974	5" / 125mm	2	4



Tiling Tools

PRO PUMP-UP SUCTION LIFTER – PLASTIC HANDLE



FEATURES

- Plastic workings
- Pump action suction activation
- Grips on to any smooth flat surface
- Sturdy steel construction with high carrying capacity for heavy loads
- Max lift capacity 100kg

Product code	Barcode	Cup Size	Inner Qty	Outer Qty
OX-P170808	9341231029981	8" /200mm	2	4

PRO PUMP-UP SUCTION LIFTER – BRASS HANDLE



FEATURES

- Brass workings
- Pump action suction activation
- Grips on to any smooth flat surface
- Sturdy steel construction with high carrying capacity for heavy loads
- Max lift capacity 150kg

Product code	Barcode	Cup Size	Inner Qty	Outer Qty
OX-P170708	9341231029988	8" /200mm	2	4

PRO POINTED RUBBER GROUTER



FEATURES

- Traditional timber handle
- Foam-rubber blade with steel insert - for rigidity

Product code	Barcode	Size	Inner Qty	Outer Qty
OX-P011995	9341231029844	3½ x 9½" / 86 x 240mm	4	12



PRO RECTANGULAR DOUBLE RUBBER GROUTER

FEATURES

- Ergonomic plastic handle
- Gum rubber blade with bevelled edges
- Plastic backer with foam cushion for even pressure



Product code	Barcode	Size	Inner Qty	Outer Qty
OX-P011812	9341231029875	4 x 12" / 100 x 300mm	4	12
OX-P011895	9341231027192	4 x 9½" / 100 x 240mm	4	12

PRO GENERAL PURPOSE SPONGE

FEATURES

- All-purpose type sponge for general cleaning
- Coarse pore for removal of heavy dirt
- Consists of large and small cell structure



Product code	Barcode	Size	Inner Qty	Outer Qty
OX-P250311	9341231030154	110 x 165 x 65mm	6	24
OX-P250313	9341231030161	130 x 200 x 70mm	6	24

PRO HYDRO HAND SPONGE

FEATURES

- The ultimate tilers sponge - made from 'Hydro' material for ultimate water holding properties
- 'Open cell' design with the 'Hydro' material, creates the most effective dirt release during 'compression load deflection'



Product code	Barcode	Size	Inner Qty	Outer Qty
OX-P250411	9341231030178	110 x 165 x 65mm	6	24
OX-P250413	9341231030185	130 x 200 x 70mm	6	24



Tiling Tools

PRO SLOTTED HYDRO SPONGE



FEATURES

- The ultimate tilers sponge - made from 'Hydro' material for ultimate water holding properties
- Open cell design with the 'Hydro' material, creates the most effective dirt release during 'compression load deflection
- The OX slotted surface design creates multiple edges to perform the cleanest 'wipe' after one swipe

Product code	Barcode	Size	Inner Qty	Outer Qty
OX-P250113	9341231030192	200 x 130 x 50mm	6	24

PRO VELCRO SPONGE HOLDER



FEATURES

- One piece handle and blade with co-moulded OXGRIP
- Velcro quick change base - glued and stapled

Product code	Barcode	Size	Inner Qty	Outer Qty
OX-P012927	9341231030208	5 x 10 1/2" / 130 x 270mm	4	12

PRO VELCRO SLOTTED HYDRO SPONGE



FEATURES

- The ultimate tilers sponge - made from 'Hydro' material for ultimate water holding properties
- Open cell design with the 'Hydro' material, creates the most effective dirt release during 'compression load deflection
- The OX slotted surface design creates multiple edges to perform the cleanest 'wipe' after one swipe

Product code	Barcode	Size	Inner Qty	Outer Qty
OX-P250215	9341231030215	6 x 12 x 1 1/2" / 150 x 300 x 35mm	6	24



PRO SLOTTED HYDRO SPONGE FLOAT

FEATURES

- One piece moulded handle and blade
- Sponge made from 'Hydro' material for ultimate water holding properties
- Open cell design

Product code	Barcode	Size	Inner Qty	Outer Qty
OX-P404814	9341231035104	5½ x 11" / 140 x 280mm	4	12



PRO HYDRO SPONGE FLOAT WITH PROFILE BASE

FEATURES

- Soft grip handle for ultimate grip and comfort
- 30mm hydro-sponge pad, highly absorbent
- Profiled for easier cleaning

Product code	Barcode	Size	Inner Qty	Outer Qty
OX-P140614	9341231040399	5½ x 11" / 140 x 280mm	4	12



TRADE TILE WASH KIT

FEATURES

- Ergonomic Handgrip
- Triple Roller System
- Swivel Castors for easy manoeuvrability
- Large 24L container made of impact resistant plastic

Product code	Barcode	Size	Inner Qty	Outer Qty
OX-T140424	9341231040320	24L	1	6





Striking & Struck Tools

OX hammers are full of features to make them perfectly balanced and built to last.

Shock absorbing ergonomically designed handles reduce hand fatigue and vibration. The quality of the steel, the balance and comfort grip handles mean they are perfect for tradesmen who want the job done right, first time every time.





PRO CLAW HAMMER

FEATURES

- Non-slip grip handle with shock reduction
- Precision balanced
- Forged, one piece steel construction
- High quality steel for durability

Product code	Barcode	Size	Inner Qty	Outer Qty
OX-P080116	5060242337994	16oz / 450g	4	12
OX-P080120	5060242337401	20oz / 560g	4	24
OX-P080124	5060242338007	24oz / 680g	4	24



LIFETIME GUARANTEE

PRO STRAIGHT CLAW HAMMER

FEATURES

- Non-slip grip handle with shock reduction
- Precision balanced
- Forged, one piece steel construction
- High quality steel for durability

Product code	Barcode	Size	Inner Qty	Outer Qty
OX-P082920	5060242338502	20oz / 560g	4	24



LIFETIME GUARANTEE

PRO FRAMING HAMMER

FEATURES

- Straight claw hammer designed for frame work
- Long handle for greater impact
- Non-slip grip handle with shock reduction
- Forged, one piece steel construction
- Precision balanced

Product code	Barcode	Size	Inner Qty	Outer Qty
OX-P082328	5060242338014	28oz / 790g	2	18



LIFETIME GUARANTEE



Striking & Struck Tools



PRO FIBREGLASS CLAW HAMMER

FEATURES

- Fibreglass shaft with an injection moulded grip
- Non-slip grip with shock reduction
- Precision balanced

Product code	Barcode	Size	Inner Qty	Outer Qty
OX-P081620	5060242337451	20oz / 570g	4	24

LIFETIME GUARANTEE



TRADE FIBREGLASS CLAW HAMMER

FEATURES

- Hardened and tempered steel head
- Solid core fibreglass handle
- Ergonomic rubber grip

Product code	Barcode	Size	Inner Qty	Outer Qty
OX-T080920	9341231013669	20oz / 560g	4	24



PRO BRICK HAMMER

FEATURES

- Accurately ground chisel end for clean cutting
- Non-slip grip handle with shock reduction
- Forged, one piece steel construction
- Precision balanced

Product code	Barcode	Size	Inner Qty	Outer Qty
OX-P082424	5060242338021	24oz / 790g	2	18

LIFETIME GUARANTEE



TRADE BRICK HAMMER

FEATURES

- Hardened and tempered steel head
- Solid core fibreglass handle
- Ergonomic rubber grip
- Head weight 24oz

Product code	Barcode	Handle Length	Inner Qty	Outer Qty
OX-T081024	9341231013638	340mm	4	24



PRO DRYWALL HAMMER

FEATURES

- Crowned, scored hammer head to reduce the chance of impact marks on plasterboard
- Cutaway and notched cutting blade for withdrawing nails and cutting laths
- Non-slip grip handle with shock reduction



LIFETIME GUARANTEE

Product code	Barcode	Size	Inner Qty	Outer Qty
OX-P082614	5060242338038	14oz / 400g	2	18

PRO ROCK PICK

FEATURES

- Accurately ground point end for accurate picking
- Non-slip grip handle with shock reduction
- Forged, one piece steel construction
- Precision balanced



LIFETIME GUARANTEE

Product code	Barcode	Size	Inner Qty	Outer Qty
OX-P083222	9341231035074	22oz / 620g	4	12

PRO CLUB HAMMER

FEATURES

- Forged, one piece steel construction
- Non-slip grip handle with shock reduction
- High quality steel for durability



LIFETIME GUARANTEE

Product code	Barcode	Size	Inner Qty	Outer Qty
OX-P082703	5060242338045	3lb / 1.3kg	2	18
OX-P082704	5060242338052	4lb / 1.8kg	2	18



Striking & Struck Tools



PRO FIBREGLASS CLUB HAMMER

FEATURES

- OXGRIP Handle
- High quality drop forged steel head
- Fibreglass handle

Product code	Barcode	Size	Inner Qty	Outer Qty
OX-P080425	9341231001963	2.5lb / 1.15kg	2	16



TRADE FIBREGLASS CLUB HAMMER

FEATURES

- Hardened high quality steel
- Extremely strong fibreglass handle
- Available in 3LB & 4LB

Product code	Barcode	Size	Inner Qty	Outer Qty
OX-T081303	9341231013645	3lb / 1.3kg	2	18
OX-T081304	9341231013652	4lb / 1.8kg	2	18



PRO HICKORY HANDLE CLUB HAMMER

FEATURES

- Hardened high quality steel
- Genuine hickory handle
- Available in 2.5LB

Product code	Barcode	Size	Inner Qty	Outer Qty
OX-P080325	9341231001956	2.5lb / 1.15kg	2	16



TRADE FIBREGLASS DEMOLITION HAMMER

FEATURES

- Hardened and tempered steel head
- Solid core fibreglass handle
- Ergonomic rubber grip



Product code	Barcode	Size	Inner Qty	Outer Qty
OX-T082004	9341231013676	4lb / 1.8kg	2	18

TRADE FIBREGLASS SLEDGE HAMMER

FEATURES

- Hardened high quality steel
- Extremely strong fibreglass handle
- Available in 7LB, 10LB, 12LB & 14LB



Product code	Barcode	Size	Inner Qty	Outer Qty
OX-T081507	9341231013706	7lb / 3.2kg	2	4
OX-T081510	9341231013713	10lb / 4.5kg	2	4
OX-T081512	9341231013720	12lb / 5.4kg	2	4
OX-T081514	9341231013737	14lb / 6.3kg	2	4

PRO HICKORY HANDLE SLEDGE HAMMER

FEATURES

- Hardened high quality steel
- Genuine hickory handle
- Fitted with steel wedges



Product code	Barcode	Size	Inner Qty	Outer Qty
OX-P080204	9341231001918	4lb / 1.8kg	2	4
OX-P080207	9341231001925	7lb / 3.2kg	2	4
OX-P080210	9341231001932	10lb / 4.5kg	2	4
OX-P080214	9341231001949	14lb / 6.3kg	2	4



Striking & Struck Tools



PRO ONE PIECE RUBBER MALLET

FEATURES

- White non marking rubber
- Steel reinforcement core
- Comfortable grip
- One piece moulded rubber

Product code	Barcode	Size	Inner Qty	Outer Qty
OX-P080605	9341231011726	17.5oz / 500g	2	12
OX-P080610	9341231011733	35oz / 1000g	2	12



TRADE BLACK RUBBER MALLET

FEATURES

- Quality, durable rubber mallet
- Solid core fibreglass handle
- Ergonomic rubber grip

Product code	Barcode	Size	Inner Qty	Outer Qty
OX-T081724	5060242332296	24oz / 680g	2	12



PRO SINGLE ENDED SCUTCH HAMMER

FEATURES

- Hickory handle
- High quality drop forged steel head
- Head weight 28oz

Product code	Barcode	Handle Length	Inner Qty	Outer Qty
OX-P080528	9341231001901	240mm	4	24



PRO DOUBLE ENDED SCUTCH HAMMER

FEATURES

- High quality drop forged steel head
- Head weight 22oz
- Hickory handle

Product code	Barcode	Handle Length	Inner Qty	Outer Qty
OX-P080522	9341231001895	340mm	4	24



PRO SCUTCH COMBS HOLDERS

FEATURES

- For detachable stone dressing combs
- Heavy duty high carbon steel
- Hardened & tempered for durability

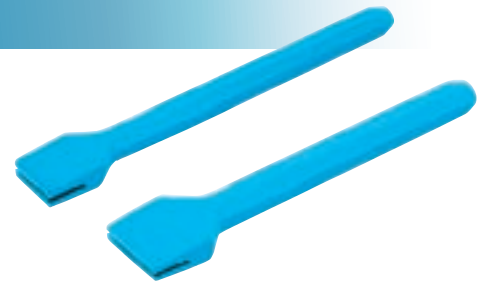

Product code	Barcode	Size	Inner Qty	Outer Qty
OX-P090310	9341231020759	200 x 25mm / 8 x 1"	4	16
OX-P090315	9341231020766	200 x 38mm / 8 x 1 1/2"	4	16

PRO SCUTCH COMBS

FEATURES

- To fit into a scotch comb holder
- For preparation of surface prior to re-rendering
- Three different sizes – 25, 38 & 50mm



Product code	Barcode	Size	Inner Qty	Outer Qty
OX-P080725	9341231010712	25mm	4	16
OX-P080738	9341231010729	38mm	4	16
OX-P080750	9341231010736	50mm	4	16

PRO CONCRETE CHISEL

FEATURES

- Forged chrome vanadium steel
- Dual hand guard
- Soft grip handle
- For cutting & breaking of concrete



Product code	Barcode	Size	Inner Qty	Outer Qty
OX-P092501	5060242334535	3/4" x 12" / 20 x 300mm	4	16

PRO COLD CHISEL

FEATURES

- Forged chrome vanadium steel
- Dual hand guard
- Soft grip handle
- For cutting & shaping iron, steel, aluminium, copper, brass, nuts & bolts



Product code	Barcode	Blade Width	Inner Qty	Outer Qty
OX-P092401	5060242334566	1" / 25mm	4	16



Striking & Struck Tools



TRADE ELECTRICIANS BOLSTER

FEATURES

- Drop forged steel
- Rubber grip handle

Product code	Barcode	Blade Width	Inner Qty	Outer Qty
OX-T090502	5060242331497	2 1/4" / 57mm	4	8



PRO ELECTRICIAN'S CHISEL

FEATURES

- Forged chrome vanadium steel
- Dual hand guard
- Soft grip handle
- For cutting & trimming of wood, wallboard & masonry

Product code	Barcode	Blade Width	Inner Qty	Outer Qty
OX-P092002	5060242334573	2 1/4" / 57mm	4	16



PRO FLOOR CHISEL

FEATURES

- Forged chrome vanadium steel
- Dual hand guard
- Soft grip handle
- For cutting, prying & ripping of nails & hard wood flooring

Product code	Barcode	Blade Width	Inner Qty	Outer Qty
OX-P092103	5060242334542	3" / 76mm	4	16



TRADE BRICK BOLSTER - WITH HANDLE

FEATURES

- Drop forged steel
- OXGRIP handle

Product code	Barcode	Blade Width	Inner Qty	Outer Qty
OX-T090945	5060242332227	4 1/2" / 115mm	4	8



PRO CONCRETE CHISEL

FEATURES

- Forged chrome vanadium steel
- Dual hand guard
- Soft grip handle
- For cutting & splitting of bricks & masonry

Product code	Barcode	Blade Width	Inner Qty	Outer Qty
OX-P092303	5060242334511	3" / 76mm	4	16
OX-P092345	5060242339424	4½" / 115mm	5	20



TRADE COLD CHISEL

FEATURES

- One piece forged steel for ultimate strength
- Hardened & tempered for durability
- For cutting & shaping masonry

Product code	Barcode	Size	Inner Qty	Outer Qty
OX-T090110	5060242330841	1" X 10" / 25 X 250mm	4	8
OX-T090112	5060242330865	1" X 12" / 25 X 300mm	4	8
OX-T090118	9341231010699	1" X 18" / 25 X 450mm	4	8
OX-T091208	5060242331459	¾" X 8" / 20 X 200mm	4	12
OX-T091210	5060242331466	¾" X 10" / 20 X 250mm	4	12
OX-T091212	5060242331473	¾" X 12" / 20 X 300mm	4	12
OX-T091218	5060242331480	¾" X 18" / 20 X 450mm	4	12



PRO GROOVED PLUGGING CHISEL

FEATURES

- High quality carbon steel
- Hexagonal shaft
- Fluted design - to prevent 'jamming'
- Chamfered striking end

Product code	Barcode	Size	Inner Qty	Outer Qty
OX-P090210	9341231022395	250 x 6mm	4	16





Striking & Struck Tools

PRO DEMOLITION BAR



FEATURES

- Heat treated, forged steel
- For pulling, lifting or prying
- Powder coated to provide maximum resistance to rusting

Product code	Barcode	Size	Inner Qty	Outer Qty
OX-P093015	5060242338083	16" / 390mm	4	16

PRO HEAVY DUTY PRY BAR



FEATURES

- Powder coated finish all steel
- Hardened steel claw
- Ideal for prying formwork

Product code	Barcode	Size	Inner Qty	Outer Qty
OX-P092856	9341231025846	56" / 1425mm	4	16

TRADE WRECKING BAR



FEATURES

- Solid steel wrecking bar
- Forged high carbon steel - one piece

Product code	Barcode	Size	Inner Qty	Outer Qty
OX-T091012	5060242330803	12" / 300mm	3	6
OX-T091018	5060242330810	18" / 450mm	3	6
OX-T091024	5060242330827	24" / 600mm	3	6
OX-T091030	5060242331503	30" / 750mm	3	6
OX-T091036	5060242330834	36" / 900mm	3	6



PRO MOULDING BAR

FEATURES

- Unique hammer head
- Multi-functional moulding bar with extra wide chisel blade
- Comfort non-slip grip handle
- Polished bevelled claw for better access



Product code	Barcode	Size	Inner Qty	Outer Qty
OX-P083110	5060242338076	10" / 250mm	4	12



PRO CLAW BAR

FEATURES

- Unique hammer head
- Multi-functional claw bar for striking, prying & pulling
- Comfort non-slip grip handle
- Polished bevelled claw for better access



Product code	Barcode	Size	Inner Qty	Outer Qty
OX-P083010	5060242339981	10" / 250mm	4	12
OX-P083012	5060242338069	12" / 300mm	4	12





Measuring Tools

Few tools are as widely used across the world as the tape measure.

We at OX recognise that and build our tapes to last the test of time. Durability, reliability and innovation are the words we think of when designing a new line of tapes.

OX has enhanced it's reputation as a leading tape rule manufacturer with the launch of the new Pro Series short tape, which boasts an impressive 3.0m stand out whilst remaining an extremely compact design.





PRO STAINLESS STEEL TAPE MEASURE

FEATURES

- Professional tape measure
- Stainless steel case with over mold for heavy duty use
- Extra tough nylon coated steel 30mm wide blade
- 3.0m stand out
- Large end hook
- Easy access thumb lock



Product code	Barcode	Size	Inner Qty	Outer Qty
OX-P029308	9341231015519	8M	6	36



PRO POWER TAPE MEASURE

FEATURES

- OXGRIP moulded rubber case
- Triple rivetted hook end
- 25mm wide metric blade

Product code	Barcode	Size	Inner Qty	Outer Qty
OX-P020108	9341231000706	8M	18	36

*Free counter display with every purchase of 18 tapes.





Measuring Tools

TRADE POWER TAPE

FEATURES

- Wide 25mm metric blade
- Ergonomic rubber grip
- Nylon coated steel blade
- Easy access sliding thumb lock
- Shock absorbing blade return bumper
- Quick release button



Product code	Barcode	Size	Inner Qty	Outer Qty
OX-T020108	9341231032349	8M	12	48
OX-T020110	9341231034008	10M	12	48

*Free counter display with every purchase of 12 tapes.

TRADE OPEN REEL TAPE

FEATURES

- High impact ABS plastic case
- Quick winding mechanism
- Ergonomic rubber grip



Product code	Barcode	Size	Inner Qty	Outer Qty
OX-T023503	9341231010668	30m	4	12

PRO COMBINATION SQUARE

FEATURES

- High quality cast and machined sliding stock
- Stainless steel rule engraved with metric graduations
- Can mark 90° and 45° with adjustable depth for repetition marking and scribing
- 305mm size

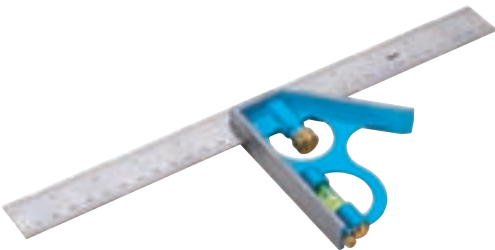

Product code	Barcode	Size	Inner Qty	Outer Qty
OX-P500530	9341231015793	300mm	6	60



PRO HEAVY DUTY ALUMINIUM 'T' SQUARE

FEATURES

- Made from high quality silver anodised structural aircraft aluminium
- Precise 'mm' - graduation markings
- Quadruple rivetted 'T' end to ensure accuracy for a long time

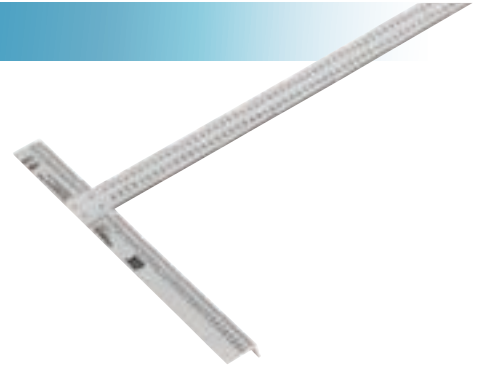

Product code	Barcode	Size	Inner Qty	Outer Qty
OX-P021114	9341231032158	50x16" / 1200x550mm	4	8

PRO CARPENTER'S SQUARE

FEATURES

- Metric markings with writing area for notes
- Heavy duty carbon steel
- Epoxy coated

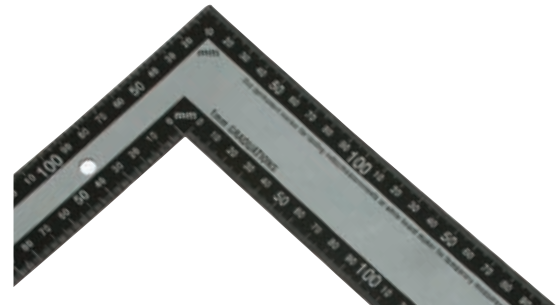

Product code	Barcode	Size	Inner Qty	Outer Qty
OX-P021064	9341231001987	24x16" / 600x400mm	4	12



Layout Tools

Lifetime vial warranty, 30mm depth extrusion and patented innovative dual view vials are just some of the features on the extraordinary OX Pro Series level.

This one is definitely stronger than an OX – and if you can find a tougher level we will give you your money back...Guaranteed!





PRO SPIRIT LEVEL

FEATURES

- The strongest level EVER or your money back!
- Unique dual view
- Silicone air cushioned handles
- Shock proof end caps
- Two milled surfaces
- One horizontal and two vertical vials

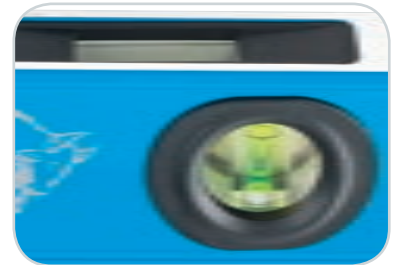

Product code	Barcode	Size	Inner Qty	Outer Qty
OX-P024406	5060242333897	600mm	3	6
OX-P024408	5060242333903	800mm	3	6
OX-P024409	5060242333910	900mm	3	6
OX-P024410	5060242333927	1000mm	3	6
OX-P024412	5060242333934	1200mm	3	6
OX-P024418	5060242333941	1800mm	3	6
OX-P024420	5060242333958	2000mm	3	6
OX-P024424	5060242333965	2400mm	3	6

Life time vial warranty

Magnified vial for better readability

Vials individually calibrated to an accuracy of 0.005"/" (0.5mm/m)

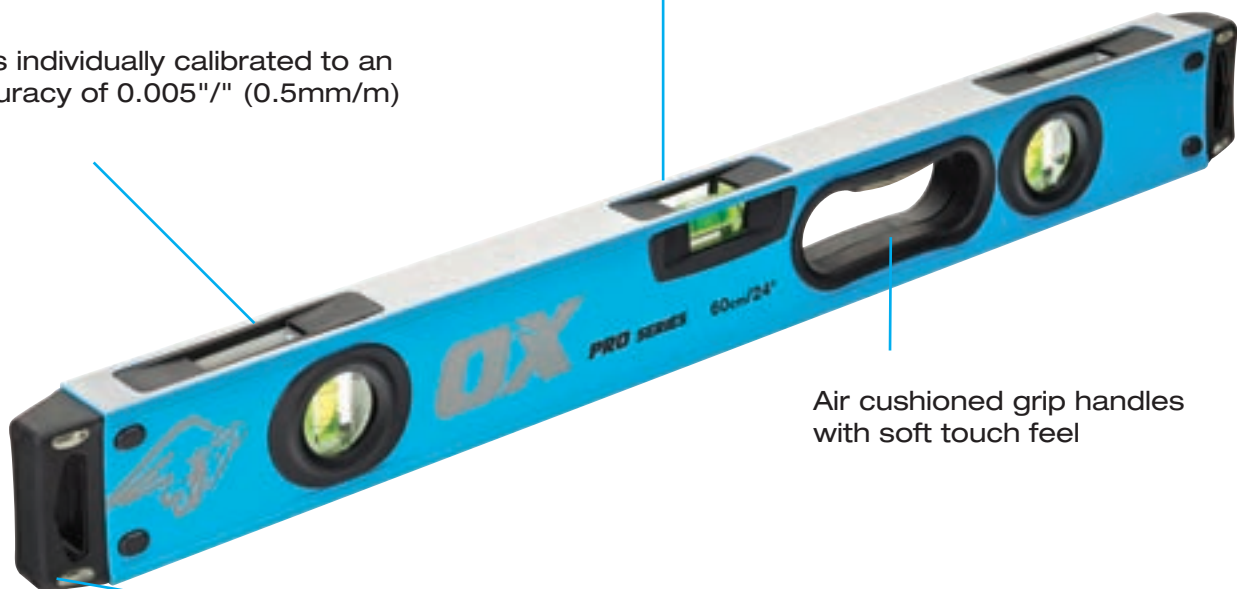

Air cushioned grip handles with soft touch feel

Shock-proof polypropylene & TPR end caps with air cushioned PVC shock absorbers



Layout Tools



PRO TORPEDO LEVEL

FEATURES

- The toughest torpedo level in the world!
- Tilted horizontal vial for direct view of bubble
- 3 unbreakable acrylic shock-proof vials
- Accuracy <math><0.0005\text{"/"}</math> (0.5mm/m)
- 25mm thick profile – extremely strong construction
- Fine milled surface with V-groove

Product code	Barcode	Size	Inner Qty	Outer Qty
OX-P027210	5060242338632	250mm	6	18



TRADE TORPEDO LEVEL – 230MM

FEATURES

- Light weight trade torpedo level
- 3 easy to read vials (horizontal, vertical, 45 degrees)
- Magnetic V-groove for pipe work and scaffolding
- Tough rubber end caps

Product code	Barcode	Size	Inner Qty	Outer Qty
OX-T026323	9341231040214	230mm	20	80

*Free counter display with every purchase of 20 torpedo levels



PRO CHALK LINE REEL

FEATURES

- Heavy duty construction
- 5:1 Gear ratio for fast rewind
- 30M Chalkline length
- Twisted polyester string for strength and durability

Product code	Barcode	Size	Inner Qty	Outer Qty
OX-P027730	5060242338861	100ft/30m	4	40



PRO HEAVY DUTY CHALK LINE REEL

FEATURES

- Extra heavy duty die-case steel construction
- Self chalking reel to mark straight lines in layout
- Streamline ergonomic case

Product code	Barcode	Size	Inner Qty	Outer Qty
OX-P020830	9341231001291	100ft / 30m	4	12



PRO ALUMINIUM CHALK LINE REEL

FEATURES

- Durable zinc alloy case
- Self locking winder handle
- Easy slide fill operation



Product code	Barcode	Size	Inner Qty	Outer Qty
OX-P020330	9341231011023	100ft / 30m	4	12

TRADE FOLDING RULE - 1M

FEATURES

- Engineered plastic
- Professional quality steel hinges
- Full sealed blister pack
- Bevelled edge on one side



Product code	Barcode	Size	Inner Qty	Outer Qty
OX-T024010	9341231015861	-	0	100

PRO LINE MARKING CHALK

FEATURES

- Contractors grade
- Long lasting
- High visibility



Product code	Barcode	Size	Inner Qty	Outer Qty
OX-T025007	9341231025662	225g Red	4	12
OX-T025009	9341231025686	225g Blue	4	12

TRADE LUMBER CRAYONS - 12 PACK

FEATURES

- Hexagonal profile - 13 x 113MM
- Will not dry out
- Waterproof
- For marking timber, concrete, bitumen, tyres, etc.



Product code	Barcode	Size	Inner Qty	Outer Qty
OX-T024701	9341231025747	Yellow	4	12
OX-T024704	9341231025778	Red	4	12
OX-T024706	9341231025792	White	4	12



Woodworking Tools

Owning quality woodworking tools says a lot about how serious a woodworker you are.

Superbly balanced chisels and tough built door clamps are products that have been designed to give users greater control and accuracy.





PRO SOLID STEEL DOOR CLAMP

FEATURES

- Solid steel, fully welded
- Holds door during; attaching hinges, routing, hanging, rebating
- Comfortable soft grip handles
- Felt covered jaws for protection against door damage
- Fits all doors – from 18mm ‘built in’ doors to 65mm ‘fire rated’ doors



Product code	Barcode	Size	Inner Qty	Outer Qty
OX-P200101	9341231001994	49cm x 30cm	2	6

TRADE CARPENTER'S PENCIL – 10PC

FEATURES

- Traditional shape chamfered rectangle
- Ideal for marking saw cuts
- High quality lead
- FREE sharpener included

Product code	Barcode	Type	Inner Qty	Outer Qty
OX-T022910	5060135479916	Red / Medium	12	48
OX-T023010	9341231035012	Green / Hard	12	48

*Free counter display when you purchase 12 packs



TRADE CARPENTER'S PENCILS - 72 PK

FEATURES

- Traditional shape chamfered rectangle
- Ideal for marking saw cuts
- High quality lead

Product code	Barcode	Type	Inner Qty	Outer Qty
OX-T022972	5060135479947	Red / Medium	4	8
OX-T023072	9341231025808	Green / Hard	4	8





Woodworking Tools

PRO SNAP OFF CARPENTER'S PENCIL



FEATURES

- Unique retractable carpenters pencil
- 9mm Carbon fibre blade always sharp for accurate marking
- Wooden grip
- Easily extend and retract the graphite marking blade

Product code	Barcode	Size	Inner Qty	Outer Qty
OX-P500601	5060359915429	-	50	500



PRO SNAP OFF REPLACEMENT BLADES

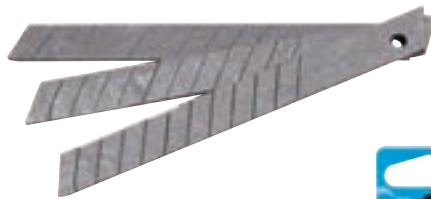

FEATURES

- Snap off replaceable pencil blades for the snap off carpenters pencil
- 9mm Carbon fibre blade always sharp for accurate marking
- These blades will fit most 9mm snap off knives
- Pack of 3 blades

Product code	Barcode	Size	Inner Qty	Outer Qty
OX-P500703	5060359915436	-	50	500





PRO WOOD CHISEL SET

FEATURES

- Steel shaft for ultimate strength
- OXGRIP handle for total control
- Metal striking cap
- Special hardened chrome vanadium
- Comes with heavy duty plastic carry case



Product code	Barcode	Size	Inner Qty	Outer Qty
OX-P370105	5060242333644	6, 13, 19, 25 & 32mm	2	8

PRO 7 PIECE SCREWDRIVER SET

FEATURES

- Chrome vanadium steel bar
- Soft grip handle moulded directly to shaft for ultimate strength
- Colour coded handles
- Robust, heavy duty case
- Set includes: Flared 6.5 x 150mm; Parallel 3.5 x 75mm & 5.5 x 125mm; Phillips PH1 x 100mm, PH2 x 125mm; Pozi PZ1 X 100mm, PZ2 x 125mm



Product code	Barcode	Size	Inner Qty	Outer Qty
OX-P360207	5060242339318	7 Pc	4	12





Cutting Tools

Tradesmen demand a lot from their cutting tools.

Our utility knives and saws are designed for ease of use, so that you can change blades without the extra tools, cut faster and longer!





PRO HEAVY DUTY TRIMMING KNIFE

FEATURES

- Quick blade changing - accepts most standard utility blades
- Firm grip handle
- Magnetic tip
- Storage for blade dispenser - 10 blades included

Product code	Barcode	Size	Inner Qty	Outer Qty
OX-P220310	5060242335259	-	4	12

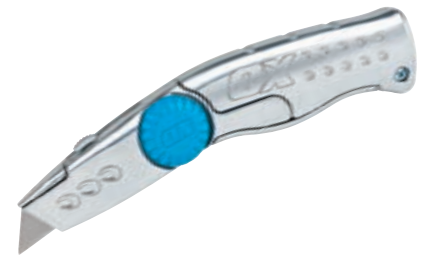

PRO RETRACTABLE FOLDING KNIFE

FEATURES

- Retractable blade knife with easy folding mechanism
- Blade storage in handle - complete with 2 blades
- Instant blade change
- Non-slip grip

Product code	Barcode	Size	Inner Qty	Outer Qty
OX-P223501	5060359914736	-	12	120



PRO FIXED FOLDING KNIFE

FEATURES

- Very compact foldable design
- Blade storage in handle - complete with 2 blades
- Very fast blade change
- Non-slip grip

Product code	Barcode	Size	Inner Qty	Outer Qty
OX-P221301	5060242339349	-	4	12



TRADE SNAP OFF KNIFE - 18MM

FEATURES

- Display box of 24pcs
- 18mm Snap off blade
- Auto lock feature
- Rubber grip
- Removable end cap to use to snap blades

Product code	Barcode	Size	Inner Qty	Outer Qty
OX-T224018-24	9341231016032	-	1	4





Cutting Tools

TRADE TRIMMING KNIFE



FEATURES

- Tough metal construction
- Accepts most standard utility blades
- Blade storage in handle
- Retractable blade

Product code	Barcode	Size	Inner Qty	Outer Qty
OX-T220601	5060242335853	-	4	12

PRO SOFT GRIP UTILITY KNIFE



FEATURES

- Sleek “flipout” blade storage cartridge in the back of the handle for extra blades
- Quick blade change – “push the button”
- Ergonomic grip for ease of use
- Dual cutting position

Product code	Barcode	Size	Inner Qty	Outer Qty
OX-P220801	9341231032370	-	4	12

PRO REPLACEMENT KNIFE BLADES



FEATURES

- Superior industrial grade blade
- Special heat treatment
- Fits most standard utility knives
- Dispenser pack, keeps blades clean and safe

Product code	Barcode	Size	Inner Qty	Outer Qty
OX-P222010	5060242332159	10 Pack	4	12
OX-P222110	5060242332364	100 Pack	4	16



TRADE FIBRO CUTTER

FEATURES

- Steel handles
- Ergonomic handle design
- Easy to use
- Clean cut

Product code	Barcode	Capacity	Inner Qty	Outer Qty
OX-T230401	9341231013010	3/8" / 10mm	4	12

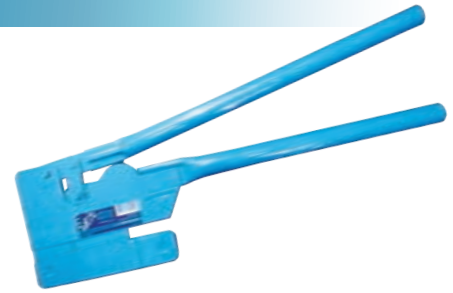

PRO HIGH TENSION 12" (300MM) HACKSAW

FEATURES

- Quick change blade design
- Bi grip rubber handle
- Blade in either 45° / 90° cut position
- No tools needed to change blade

Product code	Barcode	Size	Inner Qty	Outer Qty
OX-P130730	9341231001062	12" / 300mm	4	16



PRO 12" (300MM) HACKSAW BLADES

FEATURES

- Suit OX-P130730 hacksaw
- Cuts aluminium, iron, copper, carbon steel and hard plastic
- Pack of 4 blades
- Smooth cuts

Product code	Barcode	Size	Inner Qty	Outer Qty
OX-P131318	5060242331879	18 TPI PACK 4	6	36
OX-P131324	5060242331886	24 TPI PACK 4	6	36





Cutting Tools

PRO MASONRY SAW



FEATURES

- 750mm carbide tipped
- 34 tungsten carbide tipped teeth
- Suitable for lightweight concrete

Product code	Barcode	Size	Inner Qty	Outer Qty
OX-P133034	9341231020209	750mm	2	6

TRADE HAND SAW



FEATURES

- 500mm/20" Trade Handsaw
- Dual angle, 8tpi teeth for superior cutting performance
- High quality 65MN steel blade
- OX ergo fit handle

Product code	Barcode	Size	Inner Qty	Outer Qty
OX-T130950	9341231016646	500mm	10	10

TRADE JAB SAW WITH HOLSTER



FEATURES

- Supplied with protective holster for safety when not in use
- Hardened & tempered steel blade for increased life
- 8 Teeth per inch
- Non-slip ergonomic handle
- Excellent for wood, plastic & drywall

Product code	Barcode	Size	Inner Qty	Outer Qty
OX-T131516	5060242334429	6.5" / 165mm	12	36



PRO AVIATION SNIPS

FEATURES

- Heat treated alloy jaws
- Fully adjustable and replaceable jaws
- Rated to cut HRC49
- Max cut 1.5mm mild steel / 0.9 stainless steel



Product code	Barcode	Cut Direction	Inner Qty	Outer Qty
OX-P231001	9341231032448	Left	4	12
OX-P231002	9341231032455	Right	4	12
OX-P231003	9341231032462	Straight	4	12



Plumbing & Electrical Tools

The performance, service life and ergonomics of our tools are guided by the need to meet the high expectations of professional users.

That is why we use particularly high-quality materials and modern production technology.





PRO ULTRA-WIDE JAW ADJUSTABLE WRENCH

FEATURES

- Ultra wide jaw opening
- Very slim head for access into tight spaces
- Precision hardened for durability
- Soft grip handle
- Measurement scale on jaw



Product code	Barcode	Size	Inner Qty	Outer Qty
OX-P324606	5060242337512	6" / 152mm	4	12
OX-P324608	5060242337529	8" / 200mm	4	12
OX-P324610	5060242337536	10" / 250mm	4	12
OX-P324612	5060242337543	12" / 300mm	4	12

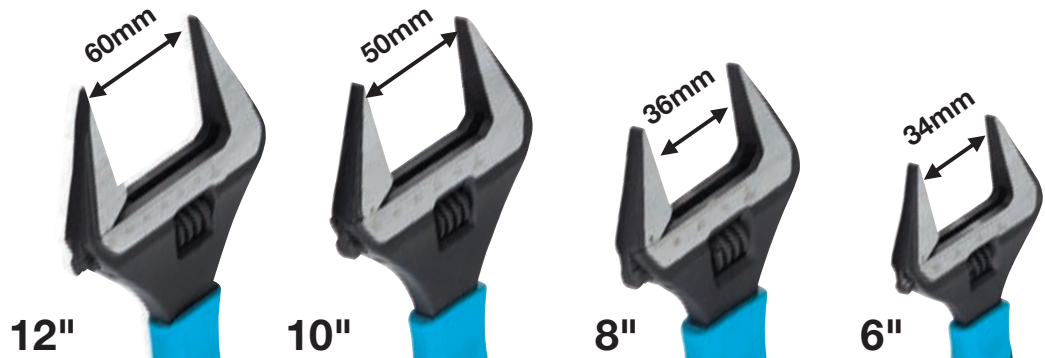

PRO LONG NOSE PLIERS

FEATURES

- Tough chrome vanadium steel
- Drop forged
- Hardened and tempered jaws
- Ergonomic grip handles with slip guards



Product code	Barcode	Size	Inner Qty	Outer Qty
OX-P321620	5060242331787	8" / 200mm	4	12



Plumbing & Electrical Tools

PRO DIAGONAL SIDE CUTTING PLIERS



FEATURES

- Tough chrome vanadium steel
- Drop forged
- Hardened and tempered jaws
- Ergonomic grip handles with slip guards

Product code	Barcode	Size	Inner Qty	Outer Qty
OX-P321416	5060242332197	6" / 160mm	4	12

PRO COMBINATION PLIERS



FEATURES

- Tough chrome vanadium steel
- Drop forged
- Hardened and tempered jaws
- Ergonomic grip handles with slip guards

Product code	Barcode	Size	Inner Qty	Outer Qty
OX-P321318	5060242332203	7 1/2" / 190mm	4	12

PRO ADJUSTABLE BASIN WRENCH



FEATURES

- Telescopic basin nut wrench
- Reversible Jaw for easy access
- 4 adjustment sizes
- 10 to 32mm Jaw Capacity

Product code	Barcode	Size	Inner Qty	Outer Qty
OX-P448401	5060359914620	10 - 32mm	1	15



PRO GROOVE JOINT PLIERS

FEATURES

- Tough chrome vanadium steel
- 5 step adjustment
- Hardened and tempered jaws
- Ergonomic grip handles with slip guards

Product code	Barcode	Size	Inner Qty	Outer Qty
OX-P325825	5060242331831	10" / 250mm	4	12



PRO AUTOMATIC WATERPUMP PLIERS

FEATURES

- Automatic waterpump pliers for fast one hand size adjustment
- Tough chrome vanadium steel
- Double dipped handle for comfort

Product code	Barcode	Size	Inner Qty	Outer Qty
OX-P326010	5060359914521	250mm / 10"	6	48





Site Tools & Accessories

OX offers a premium range of site tools to cater for every need.

Our extensive range of shovels are manufactured to withstand the heat, the cold and the building site. Don't settle for something inferior.





TRADE SPOT MARKING PAINT - 12 PACK

FEATURES

- 12 Pack
- Lead free
- Professional quality hi-visibility colours
- 350g aerosol can
- Ideal for marking out roadworks, building sites, grass and sporting areas
- Use on asphalt, dirt, concrete & timber
- Unique trigger cap for easy, safe, inverted marking



12
BOX

Product code	Barcode	Size / Colour	Inner Qty	Outer Qty
OX-T022501	9341231000553	350g / Blue	6	12
OX-T022502	9341231000560	350g / Fluro Green	6	12
OX-T022503	9341231000577	350g / Fluro Orange	6	12
OX-T022504	9341231000584	350g / Fluro Pink	6	12
OX-T022505	9341231000591	350g / Fluro Red	6	12
OX-T022506	9341231000607	350g / White	6	12
OX-T022507	9341231000614	350g / Fluro Yellow	6	12

PRO RATCHET TIE DOWN - 4 PACK

FEATURES

- 25mm X 4m polyester webbing
- Vinyl coated 'S' hooks at each end
- Lashing capacity 250Kg
- Breaking strength 500Kg
- Pack of four straps
- Complies with AS/NZS

Product code	Barcode	Lashing Capacity	Inner Qty	Outer Qty
OX-P200904	9341231024139	250kg	25	120



PRO RATCHET TIE DOWN - SINGLE

FEATURES

- 50mm x 9m blue polyester strap
- Double locking mechanism
- 2 protective sleeves
- Lashing capacity 2500kg
- Breaking strength 5000kg
- Complies with AS/NZS

Product code	Barcode	Lashing Capacity	Inner Qty	Outer Qty
OX-P201109	9341231011078	1250kg	25	210





Site Tools & Accessories

PRO 750MM SAW HORSE - 2 PACK



FEATURES

- Durable and sturdy saw horse set
- Solid bamboo benchtop 800mm length
- 750 mm High
- Lockable legs
- Locking pin

Product code	Barcode	Quantity	Inner Qty	Outer Qty
OX-P335675	9341231034466	2pcs set	5	10

PRO SINGLE STEP UPS / PRO DOUBLE STEP UPS

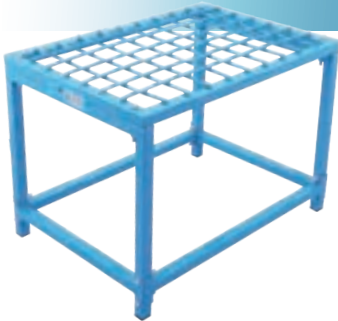

FEATURES

- Light weight
- Sturdy Construction
- Easy Assembly required

Product code	Barcode	Size	Inner Qty	Outer Qty
OX-P335701	9341231014642	Single	4	8
OX-P335702	9341231014659	Double	4	8

PRO CAULKING GUN

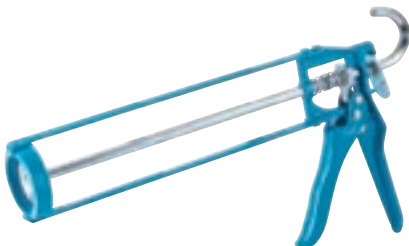

FEATURES

- Skeleton frame
- 6mm hex rod with ladder hang hook
- Quick release lever

Product code	Barcode	Size	Inner Qty	Outer Qty
OX-P040109	9341231011719	400ml	6	24



TRADE TUBULAR SEALANT GUN

FEATURES

- Heavy duty construction
- Robust operation
- Aluminium tube

Product code	Barcode	Size	Inner Qty	Outer Qty
OX-T040215	9341231025815	15" / 380mm	4	12



PRO TUBULAR SEALANT GUN

FEATURES

- Quick release lever
- Suits 600mm bulk cartridges
- Aluminium tube

Product code	Barcode	Size	Inner Qty	Outer Qty
OX-P040211	9341231035593	11" / 280mm	4	12
OX-P040215	9341231007361	15" / 380mm	4	12



PRO SEALANT GUN REPLACEMENT PARTS

FEATURES

- Genuine OX sealant gun parts
- Suits OX pro sealant gun

Product code	Barcode	Part	Inner Qty	Outer Qty
OX-P049801	9341231011702	Nozzle - 6PK	6	24
OX-P049802	9341231011757	Plunger Cap	6	12
OX-P049803	9341231013508	Threaded Collar	6	12
OX-P049804	9341231013515	Plunger Slide Sleeve	6	12





Site Tools & Accessories

TRADE FLOOR SCRAPER

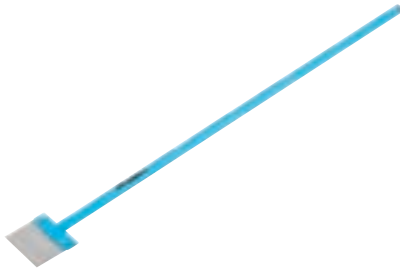

FEATURES

- All steel construction & spring steel blade

Product code	Barcode	Blade Size	Inner Qty	Outer Qty
OX-T050508	9341231011856	8" / 204mm	3	6
OX-T050512	9341231011863	12" / 300mm	3	6
OX-T050514	9341231011870	14" / 350mm	3	6
OX-T050520	9341231033759	20" / 500mm	3	6

- Replacement spring steel blade

Product code	Barcode	Suits	Inner Qty	Outer Qty
OX-T059408	9341231033766	OX-T050508	4	12
OX-T059412	9341231033773	OX-T050512	4	12
OX-T059414	9341231033780	OX-T050514	4	12
OX-T059420	9341231033797	OX-T050520	4	12

PRO ALL STEEL FLOOR SCRAPER

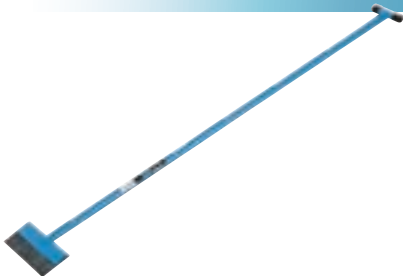

FEATURES

- All steel construction
- Spring steel blade
- T-Grip handle

Product code	Barcode	Size	Inner Qty	Outer Qty
OX-P050208	9341231001765	8" / 204mm	3	6

PRO FLOOR SCRAPER



FEATURES

- All steel head with hardwood handle
- Braced for extra strength
- Spring steel blade

Product code	Barcode	Blade Width	Inner Qty	Outer Qty
OX-P050314	9341231013041	14" / 356mm	3	6

- Replacement spring steel blade

Product code	Barcode	Suits	Inner Qty	Outer Qty
OX-P059714	9341231021954	OX-P050314	4	18



PRO HEAVY DUTY FLOOR SCRAPER

FEATURES

- All steel construction
- Spring steel blade
- Trapezoid blade
- T-Grip handle

Product code	Barcode	Size	Inner Qty	Outer Qty
OX-P050408	9341231021473	8" / 200mm	3	6

- Replacement spring steel blade

Product code	Barcode	Suits	Inner Qty	Outer Qty
OX-P059608	9341231021480	OX-P050408	4	18



TRADE SQUARE MOUTH SHOVEL

FEATURES

- 'D' grip handle
- All steel, pressed and welded construction
- High visibility blue powder coated
- Head size: 250 x 300MM

Product code	Barcode	Length	Inner Qty	Outer Qty
OX-T280107	9341231000089	1040mm	6	60
OX-T280109	9341231000072	1200mm	6	60



TRADE SQUARE MOUTH SHOVEL

FEATURES

- Long handle - rubber grip
- All steel, pressed and welded construction
- High visibility blue powder coated
- Head size: 250 x 300MM

Product code	Barcode	Length	Inner Qty	Outer Qty
OX-T280212	9341231000096	1500mm	6	60



TRADE CONCRETTERS SHOVEL - HAMMERTONE

FEATURES

- 'D' grip handle
- All steel, pressed and welded construction with a hammertone finish
- Head size: 250mm x 300mm
- Length: 1040mm

Product code	Barcode	Size	Inner Qty	Outer Qty
OX-T281307	9341231016660	1040mm	0	24





Site Tools & Accessories



PRO PLASTIC BUCKET

FEATURES

- Made in Spain
- Safety metal handle
- High grade moulded rubber

Product code	Barcode	Size	Inner Qty	Outer Qty
OX-P110610	9341231035715	10L	10	20



PRO MASONRY BUCKET

FEATURES

- Flexible HDPE material
- Non-marking smooth base
- Safety metal handle

Product code	Barcode	Size	Inner Qty	Outer Qty
OX-P110215	9341231007354	15L	0	1



PRO RUBBER BUCKET WITH POURING LIP

FEATURES

- Made in Spain
- Reinforced profile
- High grade moulded rubber

Product code	Barcode	Size	Inner Qty	Outer Qty
OX-P110615	9341231034473	15L	0	1



PRO MASONRY BUCKET

FEATURES

- Polythene construction
- Enamel steel handle
- 25L for mixing an entire bag in one go

Product code	Barcode	Size	Inner Qty	Outer Qty
OX-P110425	9341231031564	25L	0	1



PRO HEAVY DUTY RUBBER BUCKET

FEATURES

- Made in Spain
- Reinforced profile
- High grade moulded rubber

Product code	Barcode	Size	Inner Qty	Outer Qty
OX-P110640	9341231034435	40L	0	1



TRADE TRIGGER SPRAYER

FEATURES

- Twist lock pump handle
- Smooth operating trigger
- Ergonomic handles for comfort & control

Product code	Barcode	Size	Inner Qty	Outer Qty
OX-T042005	9341231032240	500ml	6	12
OX-T042010	9341231032257	1000ml	6	12



PRO EXTENSION LEAD

FEATURES

- Super duty 15 AMP cable
- Industrial plug and socket
- LED 'power on' light
- 10A plug

Product code	Barcode	Length	Inner Qty	Outer Qty
OX-P311710	9341231029431	10M	4	12
OX-P311720	9341231029448	20M	4	12
OX-P311730	9341231029455	30M	4	12



SAFETY BARRIER TAPE (SINGLE SIDED) - 20 PACK

FEATURES

- 20 pack
- Heavy duty plastic
- Single sided print
- Red & white striped

Product code	Barcode	Size	Inner Qty	Outer Qty
OX-S243110	9341231011962	75mm x 100m	3	6

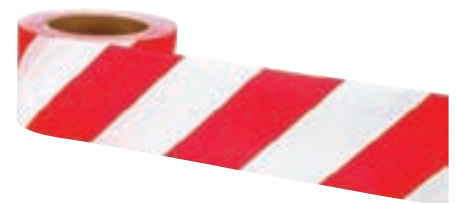



Tool Storage

Like you, we take our work seriously and believe that every detail has to be designed and manufactured with great care to ensure our products really work and also look good.

If you are looking for hard wearing, functional tool storage solutions to cope with the most extreme work conditions – OX has what you need!





PRO ROUND TOP TOOL BAG

FEATURES

- Extremely tough construction for ultimate durability
- Injected polypropylene hard base
- Strong rubber grip handle and padded shoulder strap
- Multiple use tool compartments
- Waterproof base moulded to fabric



Product code	Barcode	Size	Inner Qty	Outer Qty
OX-P261747	5060242333767	470 x 280 x 350mm	2	4

PRO TOTE BAG

FEATURES

- Extremely tough construction for ultimate durability
- Injected polypropylene hard base
- Waterproof base moulded to fabric
- Heavy-duty steel handle with rubber grip
- Open structure for quick and easy tool access
- Multiple use tool compartments



Product code	Barcode	Size	Inner Qty	Outer Qty
OX-P262618	5060242338618	18"	0	4

PRO TOOL BAG

FEATURES

- High quality durable layer nylon
- Water resistant
- Rubber feet-pads
- Internal & external pockets - 18 in total



Product code	Barcode	Size	Inner Qty	Outer Qty
OX-P260118	9341231022845	500 x 230 x 300mm	6	12



Tool Storage



PRO LEATHER TOOL POUCH WITH BELT

FEATURES

- 2 large inverted pockets, 2 medium, 6 small pockets
- Heavy duty leather belt with roller buckle
- A leather type pocket, 2 metal hammer hangers
- Riveted for added strength

Product code	Barcode	Size	Inner Qty	Outer Qty
OX-P260701	9341231010545	36"	6	12
OX-P260702	9341231010552	40"	6	12



PRO LEATHER CARPENTERS POUCH

FEATURES

- Heavy duty oil tanned leather
- A metal tape holder, 3 small tool pockets & 2 leather hammer loops
- One large main pocket with inner level pockets, 2 front nail pockets
- Riveted & wide belt slots

Product code	Barcode	Size	Inner Qty	Outer Qty
OX-P260703	9341231010569	-	4	6



PRO LEATHER FRAMERS POUCH

FEATURES

- Designed for multi tool storage
- 1 side long pockets
- Wide belt slots
- 4 tier design for easy separation of tools & fasteners

Product code	Barcode	Size	Inner Qty	Outer Qty
OX-P260704	9341231010576	-	4	6



PRO LEATHER NAIL POUCH

FEATURES

- 1 large main pocket, 1 metal hammer hanger, 1 belt level inner pocket, 2 front nail tool pockets
- Riveted & belt slot

Product code	Barcode	Size	Inner Qty	Outer Qty
OX-P260705	9341231010583	-	4	6



PRO LEATHER TOOL BELT

FEATURES

- High quality leather
- Heavy duty oil tanned leather
- Double stitching
- Metal roller buckle

Product code	Barcode	Size	Inner Qty	Outer Qty
OX-P260736	9341231010644	36" / 900mm	4	6
OX-P260740	9341231010651	40" / 1000mm	4	6



PRO LEATHER HAMMER HOLDER

FEATURES

- Fixed type
- Heavy duty leather
- Wide belt slots
- Rust proof fixed metal hammer hanger



Product code	Barcode	Size	Inner Qty	Outer Qty
OX-P260501	9341231010590	-	4	6

PRO LEATHER HAMMER HOLDER

FEATURES

- Swivel type
- Heavy duty leather
- Wide belt slots
- Rust proof fixed metal hammer hanger



Product code	Barcode	Size	Inner Qty	Outer Qty
OX-P260502	9341231010606	-	4	6

PRO LEATHER TAPE MEASURE HOLDER

FEATURES

- Fits most model of tapes
- Two finger push up pocket
- Close with strap & snap
- Wide belt slots



Product code	Barcode	Size	Inner Qty	Outer Qty
OX-P260503	9341231010613	-	4	6

PRO LEATHER CHISEL HOLDER

FEATURES

- Heavy duty leather
- Wide belt slots
- Designed to fit most chisels, rules and knives



Product code	Barcode	Size	Inner Qty	Outer Qty
OX-P260504	9341231010620	-	4	6

PRO LEATHER CORDLESS DRILL HOLDER

FEATURES

- Angled type
- Fits medium to large size cordless drill
- 3 small bit pockets, close with strap & snap wide belt slots



Product code	Barcode	Size	Inner Qty	Outer Qty
OX-P260505	9341231010637	-	4	6



Safety Equipment

If you are looking for hard wearing, functional Personal Protection Equipment to cope with the most extreme work conditions – OX has what you need.

By controlling the entire chain, from design to production to the central warehouse, we can be sure that our products are of unmatched quality and consistency.

All OX safety products meet 'EN or CE standards' where applicable.

OX is known for a 'whatever it takes attitude'. Our products pass extensive network of quality checks. If we have failed somewhere in the chain, we will correct it. To us a failed product is the same as a broken trust.

Once you have tried OX Safety you will never leave it!





SAFETY GLASSES – STANDARD CLEAR

FEATURES

- Stylish design with adjustable nose bridge for comfort
- Medium impact anti-scratch, anti-fog lens
- 99.9% UV protection for outdoor wear
- Complies with AS/NZS1337

Product code	Barcode	Colour	Inner Qty	Outer Qty
OX-S240210	9341231011320	Clear	12	48



Clear

SAFETY GLASSES – STANDARD SMOKE

FEATURES

- Stylish design with adjustable nose bridge for comfort
- Medium impact anti-scratch, anti-fog lens
- 99.9% UV protection for outdoor wear
- Complies with AS/NZS1337

Product code	Barcode	Colour	Inner Qty	Outer Qty
OX-S240220	9341231011337	Smoke	12	48



Smoked

SAFETY GLASSES – STANDARD BLUE MIRRORED

FEATURES

- Stylish design with adjustable nose bridge for comfort
- Medium impact anti-scratch, anti-fog lens
- 99.9% UV protection for outdoor wear
- Complies with AS/NZS1337

Product code	Barcode	Colour	Inner Qty	Outer Qty
OX-S240230	9341231011344	Blue mirrored	12	48



Blue Mirror



Safety Equipment

SAFETY EAR MUFFS – CLASS 4



FEATURES

- Lightweight and robust protection
- Multiple position headband
- Large sound absorbing acoustic foam filled cups
- Non magnetic
- Can be worn overhead, behind neck or under chin
- Complies with AS/NZS 1270:2002

Product code	Barcode	Qty Per Pack	Inner Qty	Outer Qty
OX-S241801	9341231013447		6	60

SAFETY DISPOSABLE EAR PLUGS – UN-CORDED



FEATURES

- Disposable PU foam
- Hearing protection for noise levels up to 110 dB(A)
- Complies with AS/NZS1270:2002
- Packed in pairs (Individual poly bags)

Product code	Barcode	Qty Per Pack	Inner Qty	Outer Qty
OX-S240402	5060242330766	200	4	12



SAFETY DISPOSABLE MASKS – NON TOXIC

FEATURES

- Non toxic dust mask
- Aluminium nosepiece can be moulded to fit
- Lightweight and comfortable for extended wear
- Ideal for protection against large dust particles



Product code	Barcode	Qty Per Pack	Inner Qty	Outer Qty
OX-S242110	9341231013881	10	6	24
OX-S242150	9341231024214	50	12	24

SAFETY DISPOSABLE MASKS – P1 DUST MASK

FEATURES

- P1 rating for protection against mechanically generated particles
- Unique design for wide variety of face profiles
- Dual straps for firm and comfortable fit
- Complies with AS/NZS1716



Product code	Barcode	Qty Per Pack	Inner Qty	Outer Qty
OX-S240605	9341231013867	5	6	24
OX-S240620	9341231024184	20	12	24

SAFETY DISPOSABLE MASKS – P2 DUST MASK

FEATURES

- P2 rating for protection against mechanically and thermally generated particles
- Unique design for wide variety of face profiles
- Dual straps for firm and comfortable fit
- Complies with AS/NZS1716



Product code	Barcode	Qty Per Pack	Inner Qty	Outer Qty
OX-S240810	9341231000157	20	12	24

SAFETY DISPOSABLE MASKS – P2V DUST MASK

FEATURES

- P2 rating for protection against mechanically and thermally generated particles
- Exhalation valve for increased air flow
- Dual straps for firm and comfortable fit
- Complies with AS/NZS1716



Product code	Barcode	Qty Per Pack	Inner Qty	Outer Qty
OX-S240903	9341231013874	3	6	24
OX-S240910	9341231000164	12	12	24



Safety Equipment

SAFETY LATEX GLOVES - POLYESTER LINED



FEATURES

- Gauge polyester, knit wrist, latex crinkle coated palm
- Made of a high-performance latex, providing outstanding combination of strength and chemical resistance
- Offers protection against snags, punctures, abrasions, and cuts
- Minimum perspiration
- Comply with CE standard regulations, meet with EN420 and EN388

Product code	Barcode	Size	Inner Qty	Outer Qty
OX-S481310	9341231037610	10	12	144

SAFETY NITRILE GLOVES - NYLON LINED



FEATURES

- 15 Gauge nylon, knit wrist, nitrile foam coated palm
- Made of a high-performance nitrile, providing outstanding combination of strength and chemical resistance
- Offers excellent dry grip by moving oils and liquids away from the glove surface
- Excellent breathability
- Comply with CE standard regulations, meet with EN420 and EN388

Product code	Barcode	Size	Inner Qty	Outer Qty
OX-S481410	9341231037627	10	12	144

SAFETY PU SYNTHETIC GLOVES



FEATURES

- Breathable with nylon liner
- Polyurethane (PU) coated palm
- Lightweight and comfortable
- Ideal for small parts handling
- Conforms to EN388 standards

Product code	Barcode	Size	Inner Qty	Outer Qty
OX-S241109	5060135479664	9	12	48
OX-S241110	5060135479671	10	12	48

SAFETY POLYESTER LINED NITRILE GLOVE - 5 PACK



FEATURES

- 13 Gauge polyester knit wrist with a smooth nitrile coated palm
- Made of high-performance nitrile, provides outstanding combination of strength and grip
- Offers excellent dry grip by moving oils and liquids away from the glove surface. Prevents grease oil and water penetration
- Comply with CE standard regulations, meet with EN420 and EN388

Product code	Barcode	Size	Inner Qty	Outer Qty
OX-S484610	9341231017513	10	0	25



SAFETY STANDARD KNEEPADS – DOUBLE STRAP

FEATURES

- Durable rubber face with foam 'liner'
- Quick release 'hook and loop' fastening
- One size fits all
- Ideal for professional trade, D.I.Y or gardening



Product code	Barcode	Size	Inner Qty	Outer Qty
OX-S240102	9341231011740	One Size Fits All	4	8

SAFETY GEL KNEEPADS – PREMIUM

FEATURES

- Anti compression air injected gel
- Foam core gives maximum cushioning
- Perforated neoprene lining keeps away moisture



Product code	Barcode	Size	Inner Qty	Outer Qty
OX-S242006	9341231001161	One Size Fits All	2	6

SAFETY STANDARD GUMBOOTS

FEATURES

- Oil, acid and abrasion resistant
- Tradesman quality with steel safety toe
- Reinforced ankle and shin for greater protection
- Sole channelling for improved liquid disposal and slip resistance



Product code	Barcode	Size	Inner Qty	Outer Qty
OX-S242408	9341231004742	8	5	10
OX-S242409	9341231004759	9	5	10
OX-S242410	9341231004766	10	5	10
OX-S242411	9341231004773	11	5	10
OX-S242412	9341231004780	12	5	10
OX-S242413	9341231004797	13	5	10





Merchandising





Also for storing products
inside the stand



ME-DSMS04

Versatile display option for stocking a wide range of OX products with 4 sides and the ability to move easily.
Dimensions: W: 66CM x H: 178CM x D: 66CM

Compact low gondola stand with double sided kit available for extra flexibility.
Dimensions: 103CM x 151CM x 52/98.5CM



Merchandising



OXPOS-STACKBOX

Dimensions:
W: 34CM x H: 41CM x D: 46CM



OX-DS450205

Dimensions:
W: 58.5CM x H: 100CM x D: 58.5CM

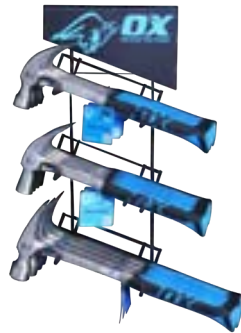

ME-DSHR03

Dimensions:
W: 25CM x H: 53CM x D: 16CM



OX-D5451703

Dimensions:
W: 50CM x H: 32CM x D: 14CM



OXPOS-LEVEL1

Dimensions:
W: 36.5CM x H: 46CM x D: 26CM

(measurements do not include any levels)





OX-D452402

Dimensions:
W: 30CM x H: 40CM x D: 15CM



Diamond Blade Troubleshooting Guide

<p>LOSS OF TENSION</p> 	<p>CAUSES</p> <p>Using the wrong blade on a specific material. A blade specifically designed and manufactured for cutting tiles will wear out extremely fast if used on highly-abrasive material such as block.</p> <p>Inadequate water is supplied to the blade.</p> <p>Bad spindle bearings, worm mounting arbor, or misaligned shaft.</p> <p>Loss of power, resulting from loose drive belts or improper voltage.</p>	<p>REMEDIES</p> <p>Avoid using general purpose specifications for cutting a single specific material. General purpose diamond blades are designed to cut a wide range of materials. Since it is unlikely an operator will be cutting an equal amount of both hard and soft materials at all times, this is not the most economical method of cutting.</p> <p>Make sure water hoses are clean and free from any blockages. Approximately nine litres of water per minute are required to properly cool a masonry saw blade. On concrete saws, 9-22 litres per minute are required.</p> <p>Replace defective parts.</p> <p>See machine manual for proper belt tightening, replace worn belts, make sure proper line voltage is being supplied to the motor.</p>
<p>BLADE WOBBLER</p> 	<p>Blade is too hard for material being cut.</p> <p>Blade has become dull as a result of being used on too hard a material.</p> <p>Blade does not cut material it was specified for.</p> <p>Insufficient power, not allowing blade to cut properly. Often, the blade will stall in the cut.</p>	<p>Select the proper blade specification for the material being cut. Consult blade recommendation chart.</p> <p>Dress or sharpen with mortar droppings or by cutting a lightweight abrasive building block to expose diamonds. If continual dressing is required, the blade specification is too hard for the material being cut.</p> <p>First, make sure the blade is correct according to the blade recommendation chart. If the blade is correct, allow it to dress itself on the material to be cut. If it does not dress itself, sharpen it as you would a dull blade, according to the procedure described above.</p> <p>Tighten belts in accordance with machine maintenance instructions. Use correct voltage at motor and adequate horsepower for cutting application.</p>



Diamond Blade Troubleshooting Guide

SEGMENT LOSS



CAUSES

On masonry saws, the material is not held firmly, which causes the blade to twist or jam in the cut and loosen the segment.

Overheating is due to inadequate supply of water or complete loss of water. This is usually accompanied by discolourations which appear on the steel centre near the area of segment loss.

Steel centre is worn thin as a result of undercutting by abrasive fines generated during cutting. The steel centre (blank) wears to a knife edge, weakens and causes a segment to be separated.

Defective blade collars cause the blade to flutter in the cut or fail to adequately support the blade in perfect alignment.

Blade is too hard for material being cut, causing excessive dullness and segment separation due to impact or fatigue. This can also cause frictional heat that can melt the braze when insufficient water is supplied to the blade.

Blade is cutting out of round resulting in a pounding impact.

Improper blade tension causes high pressure on the segments and subsequent failure of the brazed joint.

REMEDIES

Hold the material firmly against the backstop.

Provide adequate water flow to both sides of the blade. Look for line blockages. On concrete saws, temporary complete loss of water can result from equipment running over the water feed hoses.

Use sufficient water to flush fines out of the cut.

If generated fine s are highly abrasive, blades with undercut protection.

Clean foreign material from the blade clamping disc surfaces, ore replace clamping discs if they are under manufacturer's recommended diameter.

Use the proper blade specifications for the material being cut.

Replace worn bearing, realign blade shaft, or replace worn spindle.

Make sure the running speed of equipment is specified when ordering blades. On concrete saws, the spindle speed should be checked with a tachometer to ensure that each diameter blade is running at the recommended cutting speed and blade-tensioned speed.

DISTORTED CENTRE STEEL



Inadequate tightening of the blade on concrete saw mounting shaft. This causes drive pin to force its way through blade blank.



Dropping saw head with mounted blade particularly on concrete saws. Also dropping objects on unmounted blade distorts blade blanks.

Tighten clamping nut securely.

Avoid dropping the blade. Protect blade from abuse and handle with care.





Diamond Blade Troubleshooting Guide

UNEVEN SEGMENT 	CAUSES	REMEDIES
CRACKS IN SEGMENTS 	<p>The blade is too hard for the material being cut.</p>	<p>Use blade with a softer bond.</p>
CRACKS IN STEEL CENTER 	<p>Blade flutters in a cut as a result</p> <p>Blade specification is too hard for material being cut.</p> <p>Forcing blade in operation.</p> <p>Twisting blade in cut.</p>	<p>Tighten the blade clamping disc nut. Be sure that the blade is running at the properly tensioned speed and that the drive pin is functioning properly.</p> <p>Use softer blade bond to eliminate stresses which create cracks.</p> <p>Allow blade to cut freely without bouncing.</p> <p>Ensure blade is kept in straight line do not force around corners.</p>





Diamond Blade Troubleshooting Guide

SHORT LIFE 	CAUSES	REMEDIES
BLADE WILL NOT CUT 	<p>Using the wrong blade on a specific material. A blade specifically designed and manufactured for cutting tiles will wear out extremely fast if used on highly-abrasive material such as block.</p> <p>Inadequate water is supplied to the blade.</p> <p>Bad spindle bearings, worm mounting arbor, or misaligned shaft.</p> <p>Loss of power, resulting from loose drive belts or improper voltage.</p> <p>Blade is too hard for material being cut.</p> <p>Blade has become dull as a result of being used on too hard a material.</p> <p>Blade does not cut material it was specified for.</p> <p>Insufficient power, not allowing blade to cut properly. Often, the blade will stall in the cut.</p>	<p>Avoid using general purpose specifications for cutting a single specific material. General purpose diamond blades are designed to cut a wide range of materials. Since it is unlikely an operator will be cutting an equal amount of both hard and soft materials at all times, this is not the most economical method of cutting.</p> <p>Make sure water hoses are clean and free from any blockages. Approximately nine litres of water per minute are required to properly cool a masonry saw blade. On concrete saws, 9-22 litres per minute are required.</p> <p>Replace defective parts.</p> <p>See machine manual for proper belt tightening, replace worn belts, make sure proper line voltage is being supplied to the motor.</p> <p>Select the proper blade specification for the material being cut. Consult blade recommendation chart.</p> <p>Dress or sharpen with mortar droppings or by cutting a lightweight abrasive building block to expose diamonds. If continual dressing is required, the blade specification is too hard for the material being cut.</p> <p>First, make sure the blade is correct according to the blade recommendation chart. If the blade is correct, allow it to dress itself on the material to be cut. If it does not dress itself, sharpen it as you would a dull blade, according to the procedure described above.</p> <p>Tighten belts in accordance with machine maintenance instructions. Use correct voltage at motor and adequate horsepower for cutting application.</p>



Diamond Blade Troubleshooting Guide

BLADE BORE OUT-OF-ROUND	CAUSES	REMEDIES
 UNDERCUTTING STEEL CENTRE	<p>Abrading or wearing away of the steel centre faster than the diamond segment is due to highly abrasive fines generated during cutting.</p>	<p>Use as much water as possible to flush out fines generated during cutting or use blades with undercut protection. NOTE: Blades with undercut protection are not always the final answer to eliminating undercutting. Are must still be taken to provide sufficient water to the steel centre are immediately adjacent to the segment. This is especially important when making deep cuts.</p>
 BLADE WORN OUT-OF-ROUND	<p>Shaft bearings on masonry or concrete saws are worn, causing the blade to run eccentrically and wear out-of-round.</p> <p>Engine is not properly tuned on concrete saws, causing surges in blade rotation.</p> <p>Blade spindle hole is damaged from previous mis-mounting.</p> <p>Blade mounting spindle is worn. A groove may have been scoured on the mounting spindle as a result of previous blades spinning on the arbor. When a new blade is placed on such a worn spindle, it seats improperly and runs eccentrically.</p> <p>Blade slips on arbor shaft.</p> <p>Bond is too hard for material causing machine to 'pound' at regular intervals, wearing one half of the blade more that the other half.</p>	<p>Install new blade shaft bearings or blade shaft, as required.</p> <p>Tune engine according to saw manufacturer's manual.</p> <p>For large diameter blades it may be possible to rebraze segments to a new centre.</p> <p>Replace worn shaft or spindle bushing.</p> <p>On a masonry saw, tighten the blade collar. On a concrete saw, make certain that the drive pin is functioning.</p> <p>Use proper blade specification.</p>



Alphabetical Index

A	Door Clamp 127	Heavy Duty Scraper 99
Acid Brush 73, 87	Door Gauges 69	Hopper Gun 87
Adjustable Wrench 137	Dori Blocks 69	J
All Sides Up Float 49	Dry Core Case 32-33	Jabsaw 134
Aluminium Hawk 81	Dry Core Drills 31-32	Joint Knives 75
Aviation Snips 135	Drywall Hammer 109	Jointers 63-64
B	Dust Masks 155	Joint Raker 65
Bags 149	Dutch Pins 66	K
Bannister Brush 73	E	Knee Pads 157
Barrier Tape 147	Ear Plugs 154	Kneeling Board 55
Block Carrier 71	Edgers 45-48, 52	Knives
Bolsters 114	End Cutting Nippers 38-39	Folding Knife 131
Bolt Cutters 39	Extension Leads 147	Joint Knife 75
Brick Bolster 114	F	Replacement Blades 132
Brick Carrier 71	Fibre Cement Blade 30	Score 'n' Snap Knife 75
Brick Hammer 109	Fibro Cutter 133	Snap Off 131
Brickies Brushes 73	Finishing Broom 54	Taping Knife 76
Brick Jointer 64	Finishing Trowels 50-51, 77, 83-84	Trimming Knife 131-132
Brick Splitter 72	Floats 43, 48-50, 52, 82-83, 85-86, 105	Utility Knife 132
Bricklayers Clamp 70	Floor Scrapers 144-145	L
Buckets 146-147	Folding Knife 131	Levels 100, 123-124
Builders Line 66	G	Spirit Level 123
Bullfloats 43	Gauging Trowels – Brickies 62	Tilers Level 100
C	Gauging Trowels – Tilers 98	Torpedo Level 124
Carpenters Pencils 127-128	Gloves 156	Latex Gloves 156
Carpenters Square 121	Grouters 102-103	Leather Gear 150-151
Caulking Gun 142	Grout Removers 98	Line Blocks 67
Chalk Line Reels 124-125	Groovers 45, 52	Line Pin 67
Chalk Refills 125	Gumboots 157	Lumber Crayons 125
Chisels 113-115, 129	H	M
Chisel Holder 151	Hacksaws & Blades 133-134	Magnesium Float 49-50
Clamps - Door 127	Hammers 107-112	Mallets 113
Claw Bar 117	Brick Hammer 108	Margin Trowel 63
Clip Together Handle 44	Claw Hammer 107	Masks 155
Cold Chisel 113, 115	Club Hammer 109-110	Masonry Bucket 146
Combination Square 120	Demolition Hammer 111	Masonry Saw 134
Concrete Rakes 40-41	Display Rack 160	Merchandise Stands 160
Concrete Sprayer 56-57	Drywall Hammer 109	Midget Trowel 86
Cordless Drill Holder 151	Framing Hammer 107	Mitre Box 80
Core Drills 31-32	Rock Pick 109	Mixing Drill 89
Corner Trowels – External 76	Rubber Mallet 112	Mixing Paddles 90-93
Corner Trowels – Internal 75-76	Scuth Hammer 112	Mortar Raking Blade 27
Cup Wheel 28-29	Sledge Hammer 111	Mortar Smoothing Tools 63
D	Straight Claw Hammer 107	N
Demolition Bar 116	Hammer Holster 151	Nail Puller 117
Diamond Blades 13-26, 30	Hammer Rack 160	Non-Stain Roll Jointer 64
Display Stand 158-160	Hawk 81	
Disposable Masks 155		



Notch Trowels	97-98	Screwdrivers	129	Trowels	
O		Scrub Brush	73	Brick Trowel.....	62-63
Open Reel Tape.....	120	Scutch Combs.....	113	Corner Trowel - External.....	76
P		Scutch Hammer	112	Corner Trowel - Internal.....	75-76
Pads (Knee).....	157	Shovels.....	40, 145	Coving Trowel.....	48
Pencils.....	127-129	Sledge Hammers.....	111	Gauging Trowel.....	62, 98
Pick (Rock).....	110	Small Tools	75	Heart Shape Trowel.....	98
Plaster Scoop.....	80-81	Snap Off Knife.....	129	Margin Trowel.....	63
Plasterer's Square	80	Speedskim	78-79	Notch Trowel - Square.....	97-98
Plastic Floats.....	82-83	Spinner Float.....	49	Notch Trowel - V.....	97
Plastic Trowels.....	83	Spirit Levels.....	123	Plastic Finishing Trowel.....	81
Pliers	137-139	Sponges.....	85-86, 103-105	Pointed Finishing Trowel.....	50
Plugging Chisel	115	Sponge Floats – Renderers.....	85-86	Pointing Trowel	62
Pointed Finishing Trowel.....	50	Sponge Floats – Tilers.....	103	Pool Trowel.....	51
Pointing Trowel	62	Spoon Jointer.....	63	Square Finishing Trowel - Rendering.....	84
Polystyrene Floats	85	Spot Marking Paint.....	141	Square Front Trowel.....	81
Polyurethane Floats.....	82	Squares	120-121	Tilt Trowel.....	53
Pool Trowels	51	Square Finishing Trowel	51	Ultraflex Trowel.....	77
Pouches.....	150	Square Front Trowel - Tilers	81	Walking Trowel	53, 54
Profile Clamps.....	68	Square Mouth Shovel.....	145	Walking Brackets	53
Profile Pole.....	70	Squeegees.....	54	Trowel Machine Blades.....	58-59
Profile Prop.....	71	Step Ups	142	Tubular Sealant Gun	143
Pry Bars.....	116	Straight Edges.....	41	Tuck Pointing Blades.....	27
R		String Lines.....	66	Tungsten Carbide Grit File	99
Rakes – Aluminium	40-41	Suction Lifter	101-102		
Ratchet Straps	141	T		U	
Rebar Bender/Cutter.....	39	T Square	121	Ultraflex Trowel.....	77
Reels	37, 120, 124-125	Tape Measures.....	119-120	Utility Knives	132
Chalk Line Reel.....	124	Tape Measure Holder.....	151		
Fast Retrieval Chalk Line Reel.....	124	Taping Knives.....	76	W	
Tape Measure	120	Telescopic Handle	44	Walking Trowels.....	53-54
Tie Wire Reel.....	37	Texture Gun & Parts	87-88	Wall Scraper	99
Replacement Blades.....	128	Tie Wire Reel.....	37	Water Brush	86
Roller Raker	65	Tie Wire Twister	37	Wedges.....	97
Rub Brick.....	55	Tile Core Drills.....	35	Weephole Cleaner	86
Rubber Grouter.....	102-103	Tile Nippers.....	95-96	Wet Core Drills	34
Rubber Mallets.....	112	Tile Scriber	96	Wire Twister.....	37
Rubber Sponge Float	85	Tile Spacers	96-97	Wood Chisel	129
S		Tile Wedges	97	Wrecking Bar	116
Safety Glasses.....	153	Tile Wash Kit.....	105	Wrench	137
Safety Gloves	156	Tilers Levels.....	100		
Saw Horse	142	Timber Float.....	48		
Saws	133-134	Toolbags.....	149		
Score & Snap Knife.....	75	Tool Belts.....	150		
Scrapers & Replacement Blades		Top Steady Bars.....	70		
Wall Scraper	99	Top Steady Nail-on Clamp	69		
Floor Scraper	144-145	Torpedo Levels.....	124		
Screeds	42	Trigger Sprayers.....	147		
		Trim Cutter.....	96		
		Trimming Knives	131-132		



FAQ's

Answers

- Can I get a product on an urgent airbag? Yes we can freight product in an airbag overnight. There will be a \$25 fee and the order needs to be booked before 10.30am AEST and be within 5kg weight and 40cm.
- Can I pick up my order from the warehouse?..... Orders can be picked up from the warehouse. There will be a \$25 fee and an order reference number must be obtained from Customer Service before collection. 2 hours notice must be given.
- Can I place an order without an account?..... An account application must be completed and approved as a qualified distributor before placing orders.
- How do I apply for an account..... Email the Customer Service Team at sales@oxgroup.com.au for an account application form.
- How long will it take for my account to be opened? Once application has been submitted, applicant will be contacted within 5 business days in view of account being opened within 10 business days.
- Do you provide your pricelist in an excel version? Yes. Please contact customer service at sales@oxgroup.com.au to receive a copy.
- Do you accept Amex? Mastercard & Visa are our accepted credit card methods.
- Is there a surcharge if I pay via credit card? Credit card payments incur a 3% surcharge.
- Do you have a minimum order value? \$50 is minimum order value.
- Do you offer same day dispatch? All orders placed by 12:00pm AEST will be dispatched the same day
- Does OX sell to the public..... OX only sells to authorised resellers, these distributors can be located via our website.
- How long has the OX brand been around? Our tool range was born in 1974 in Perth, Australia and was launched under the OX brand at the beginning of 2010.
- What are the pack qtys?..... All pack quantities are listed in this catalogue.
- What category do you specialise in?..... OX Group has 44 years of experience in the wet trade tool market, diamond tool market and offers a range in multiple categories in the construction industry.
- What is my reps mobile number?..... Please call 02 8845 6600 for your reps mobile number.
- What is our minimum order value for FIS?..... \$350 Net
- What is the freight charge under FIS? \$19.95. This excludes access product. Contact our Customer Service Team for a price for freight costs on our access range.
- What is your returns policy?..... At OX, we have a sale or return policy. If you cannot sell an OX brand product within 3 months of purchase, simply return it in a suitable/ saleable condition for a full refund.
- How long will it take to freight? See below graph of freight transit times*.

Destination	Days truck leaves SYD	Lead time	Destination	Days truck leaves SYD	Lead time
Adelaide	Daily	2 working days	Karratha	Daily via Perth	2-3 working days
Albury	Daily	Next working day	Melbourne	Daily	Next working day
Alice Springs	Daily via Adelaide	4 working days	Mt Isa	Daily via Brisbane	5-6 working days
Brisbane	Daily	Next working day	Orange	Daily	Next working day
Bundaberg	Daily via Brisbane	2 working days	Perth	Daily	Next working day
Cairns	Daily via Brisbane	3 working days	Sydney	Daily	Next working day
Canberra	Daily	Next working day	Townsville	Daily via Brisbane	3 working days
Nowra	Daily	Next working day	Winnellie	Daily via Adelaide	5 working days
Darwin	Daily via Adelaide	5 working days	Newcastle	Daily	Next working day
Devonport	Daily via Melbourne	4-5 working days	Riverina	Daily to Wagga depot	Dependant on delivery town
Hobart	Daily via Melbourne	4-5 working days			

* All lead times are estimated lead times only.



Terms and Conditions

1. INTERPRETATION

- (a) 'Contract' means the standard trading terms and conditions of sale (which applies to each and every Quotation and/or Order) and includes any Quotation and Order
- (b) 'OX Group' means
- (c) 'Customer' means the entity to which 'OX Group' enters into a Contract for the sale of Goods.
- (d) 'Goods' means the goods described in the Quotation or Order and includes replacement goods.
- (e) 'Order' means a written or verbal order from the Customer to OX Group.
- (f) 'Quotation' means a written or verbal quotation provided by OX Group to the Customer.

2. ORDERS

- (a) Orders for Goods will be binding upon OX Group and the Customer. However, OX Group reserves the right to accept orders in whole or in part.
- (b) Once OX Group has accepted an Order, the customer may not alter or modify the Order without the prior written consent of OX Group.
- (c) 15% Re-stocking fee applies to all returned products providing they are in re-saleable condition.

3. PRICES

- (a) All prices contained in the Quotation and/or Order will be exclusive of GST. All prices are in Australian dollars and subject to alteration without notice. All invoices are in Australian dollars and must be settled in Australian dollars.
- (b) Any order placed with a value of under \$50.00 excluding GST will not be processed. This minimum invoice value does not apply to back-orders.
- (c) Handling fee of \$19.95 will be applied to the total of every invoice, excluding back-orders
- (d) Orders with an invoice value of over \$350.00 excluding GST will be shipped free in-store
- (e) Orders with an invoice value of under \$350.00 excluding GST will be charged a freight charge of \$19.95 (Freight charges subject to change)

4. PAYMENT AND CREDIT TERMS

- (a) Unless otherwise agreed in writing, the payment due date is strictly thirty, (30) days from the end of the month in which the Goods are purchased.
- (b) Accounts with overdue balances will automatically have credit withdrawn until all outstanding balances are cleared. OX Group reserves the right to charge interest at the rate of 2% on all overdue balances calculated on a daily basis from the due date until such amount is paid.
- (c) If the Customer defaults in payment of any invoice when due, the Customer will indemnify OX Group from and against all OX Group's costs and disbursements including a solicitor and own client basis and in addition to OX Group's nominee's costs of collection.

5. DELIVERY OF GOODS AND RISK

- (a) Delivery of the Goods shall be made to the Customer's address. The Customer shall make all arrangements necessary to take delivery of the Goods whenever they are tendered for delivery.
- (b) The failure of OX Group to deliver will not entitle the Customer to treat this Contract as cancelled.
- (c) OX Group will not be liable for any loss or damage whatever due to failure by OX Group to deliver the Goods (or any part of them) promptly or at all.
- (d) All risk for the Goods passes to the Customer on delivery even if OX Group retains ownership.
- (e) Delivery will be free in store (FIS) Australia wide for Orders in excess of \$350.00 + GST. However, the Customer will be liable delivery charges if a delivery date is required outside of usual delivery times. Orders less than \$350.00 + GST will be subject to the current freight charge of \$19.95 (Freight charges subject to change)

6. RETENTION OF TITLE

- (a) All Goods remain the property of OX Group until the Customer has paid for the Goods in full. If payment is made by cheque, payment will not be deemed to have been made until the cheque has been honoured.
- (b) If the Goods are on-sold by the Customer before payment to OX Group, the proceeds of sale will become

property of OX Group.

- (c) If the Goods are not paid for pursuant to clause 4, OX Group may give notice in writing to the Customer to return the Goods or any part of them to OX Group.
- (d) OX Group may enter the Customer's premises without notice at any time and take possession of the Goods and without being responsible for any damage thereby caused if:
 - (i) The Customer does not pay for the Goods under clause 4;
 - (ii) The Customer fails to return the Goods upon demand;
 - (iii) A trustee in bankruptcy, Administrator, or receiver and manager is appointed over the Customer;
 - (iv) Winding-up proceedings in relation to the Customer are commencing; or
 - (v) The Customer becomes bankrupt.

7. CLAIMS

- (a) The Customer will inspect the Goods on delivery and will within seven (7) days of delivery notify OX Group in writing of any alleged defect, shortage in quantity, errors, omissions or failure to comply with the Order or Quotation.
- (b) The Customer will afford OX Group the opportunity to inspect the Goods within a reasonable time of delivery if the Customer believed the Goods are defective in any way. If the Customer fails to comply with these provisions, the Goods will be deemed to be free from any defect or damage and payment will be owing under this Contract.
- (c) If OX Group agrees in writing that the Customer is entitled to reject the Goods because they are defective:
 - (i) The Goods must have a corresponding invoice number quoted;
 - (ii) Freight charges incurred for the return of the Goods being returned is at the expense of the Customer, unless otherwise agreed; and
 - (iii) OX Group's liability is limited to either replacing or repairing the Goods at its discretion.
- (d) OX Group does not warrant that the Goods are fit for any particular purpose or an intended use by the Customer.

8. LIMITATION OF LIABILITY

- (a) Subject to clause 8(b), OX Group will have no liability whatsoever for any direct or indirect losses, expenses, damages and costs incurred by the Customer caused by any breach by OX Group of this Contract or any negligent act or omission.
- (b) The liability of OX Group to the Customer in the event of any breach of this Contract or other cause of action will not exceed the prices of the Goods.

9. PRIVACY ACT 1998

- (a) The Customer agrees for OX Group to obtain from a credit-reporting agency and the trade referees a credit report containing personal credit information about the Customer and any additional information required by OX Group.
- (b) OX Group may exchange information about the Customer with those trade referees name in the application form for a trading account or named in a consumer credit report issued by reporting agency to:
 - (i) Assess the Customer's application;
 - (ii) Notify other credit providers of a default by the Customer;
 - (iii) Exchange other information with other credit providers as to the status of the trading account, if the Customer is in default with other credit providers; and
 - (iv) Assess the credit worthiness of the Customer.

10. GENERAL

- (a) If any provision of these terms and conditions becomes void or unenforceable, it will be severed from this agreement without affecting the enforceability of the other provision, which will continue to have full force and effect.
- (b) These terms and conditions are governed by the laws of New South Wales and each party irrevocably and unconditionally submit to the nonexclusive jurisdiction of the courts of New South Wales.
- (c) OX Group may terminate or vary this Contract or cancel delivery of Goods at any time before the Goods are

delivered by giving written notice. OX Group will not be liable for any loss or damage whatever arising from termination or cancellations.

- (d) The Customer acknowledges and agrees that the products sold to the Customer by OX Group cannot be offered for sale through third party shopping websites or platforms (including but not limited to Amazon and Gumtree) without the express written authorisation of OX Group.

11. PERSONAL PROPERTY SECURITY ACT (PPSA)

11.1 The Customer agrees, at the request of OX Group, to enter into a Security Agreement with OX Group to grant in favour of OX Group a Security Interest in all the Customer's present and after acquired property relating to the Goods.

11.2 The Customer acknowledges and agrees that it shall, within 14 days of request from OX Group, do all things and sign all documents as required by OX Group to register, confirm or validate the Security Interest created over the Customer's assets by any Security Agreement.

11.3 OX Group may exercise its rights under the Security Agreement any time after the Customer fails to comply with this Agreement, without OX Group first having to take any action or enforce any of its other rights against the Customer.

11.4 The Customer will be entitled to a release of the Security Agreement when all its obligations under this Agreement have been satisfied.

11.5 The Customer shall not without OX Group's prior written consent, which will not be unreasonably withheld, do any of the following:

- (a) acquire any asset which is, or upon acquisition, will be subject to a Security Interest which is not a Permitted Security Interest; or
- (b) give any person other than OX Group control or possession of the Goods (other than under a Permitted Security Interest).

11.6 The Customer agrees that it will promptly take such action as OX Group may require (including providing information or signing documents) to ensure that any Security interest granted in favour of OX Group attaches to the secured property and to enable OX Group to perfect any such Security Interest or otherwise exercise any rights that it may have under the PPSA Law in relation to the secured property.

11.7 The Customer acknowledges and agrees that, from the registration commencement time under the PPSA:

- (a) it shall not cause or permit any person to take a Security Interest over, or to register a financing statement in relation to, any secured property without the prior written consent of OX Group and will immediately notify OX Group if it becomes aware of any person taking steps to register a financing statement in relation to such secured property;
- (b) it has no rights under, or by reference to, sections 125, 142 and 143 of the PPSA if it defaults and OX Group takes enforcement action under this Agreement in respect of the secured property;
- (c) it waives its rights to:
 - (i) receive any notice under sections 95, 130 and 135 of the PPSA in relation to the enforcement of any Security Interest over the secured property;
 - (ii) receive a statement of account under section 132(3) (and 132(4) of the PPSA if OX Group disposes of any of the secured property following repossession of that secured property; and
 - (iii) receive a copy of, or notice of, any verification statement confirming registration of a financing statement or a financing change statement relating to any Security Interest under, or provided for by, this Agreement.

11.8 Except if section 275(7) of the PPSA applies, each party to this Agreement agrees not to disclose any information of the kind referred to in section 275(1) of the PPSA that is not publicly available.



Warranty

OX Group International Pty Ltd (OX Group) warrants that all products supplied by it and purchased by you from Authorised OX Group Dealers throughout Australia are free of defects except for those products listed under Warranty Exclusions.

Warranty Claims

If you consider that any product supplied by OX Group is defective, you can lodge a claim under this Warranty and any apparent fault will be rectified free of charge by OX Group or an OX Group Authorised Service Dealer within the Warranty Period, which is effective from the date of purchase provided that you meet the following conditions;

- You must produce the original invoice/receipt or other proof of purchase document disclosing the purchase date.
- All costs of installation, cartage, freight, travelling expenses, hiring tools and insurance are paid by the customer.
- The product, being precision equipment, has not been misused, adjusted or serviced by any person other than an OX Group Authorised Service Dealer.
- The equipment has been installed correctly and is used in accordance with the OX Group instructions supplied with the product.

OX Group provides this warranty in addition to all other rights and remedies that you may have under law in relation to the products to which this warranty relates.

Our goods come with guarantees that cannot be excluded under the Australian Consumer Law. You are entitled to a replacement or refund for a major failure and for compensation for any other reasonably foreseeable loss or damage. You are also entitled to have the goods repaired or replaced if the goods fail to be of acceptable quality and the failure does not amount to a major failure.

Notwithstanding the preceding clause, OX Group's liability in respect of a breach of a consumer guarantee or any warranty made under these Conditions of Warranty for any products not of a kind ordinarily acquired for personal, domestic or household use is limited, to the extent permissible by law and at the option of OX Group to:

1. Replacing the products or the supply of equivalent products;
2. The repair of the products;
3. The payment of the cost of replacing the products or of acquiring equivalent products; or
4. The payment of the cost of having the products repaired.

To the extent permitted by law, all other warranties whether implied or otherwise, not set out in these Conditions of Warranty are excluded and OX Group is not liable in contract, tort (including, without limitation, negligence or breach of statutory duty) or otherwise to compensate the customer for:

1. Any increased cost or expenses;
2. Any loss of profit, revenue, business, contracts or anticipated savings;
3. Any loss or expense resulting from a claim by a third party; or
4. Any special, indirect or consequential loss or damage of any nature whatsoever.

If you wish to make a claim under this Warranty, you should:

- Contact Ph: +612 8845 6600;
- Visit your nearest Authorised OX Group Dealer;
- Visit OX Group website for details: www.oxtools.com

These conditions may only be varied with the written approval of the directors of OX Group International.

Warranty Period

Product Type	Warranty Period
Diamond Tools	12 Months
Hand Tools	12 Months
Access Equipment	12 Months
Safety Equipment	12 Months
Construction Machinery	12 Months

Warranty Exclusions

This section identifies what is excluded under this Warranty.

This Warranty does not cover damage caused by:

- Misusing, overloading or abusing the OX product,
- Operating the product in a manner that is not in accordance with the OX Group instructions supplied with the product (the "Instruction Manual"),
- Failing to clean the product in accordance with the instructions for correct and regular cleaning as set out in the Instruction Manual,
- Not carrying out periodic maintenance,
- Neglecting or otherwise failing to maintain the product in accordance with the instructions for maintenance of the product including regular tune-ups, lubrication etc....,
- Using incorrect voltage or non-authorised electrical connections with the product,
- Installing the product incorrectly,

- Using non authorised/non-standard parts, non-genuine OX Group parts in connection with the product,
- Repairing or carrying out any work on the product by someone other than an Authorised OX Group Service Dealer,
- Causing a double burnout - field and armature burnout,
- Operating the product with any guard, shield or line cutting knife removed, repositioned, or that is incomplete or damaged,
- Using or operating the product with any evidence of partial failure of product or damage being present,
- Tampering with the product in any way other than in accordance with the manual,
- Not having taken reasonable steps to prevent the damage or failure from occurring to the product,
- Storing the product inconsistently with manufacturer's recommendations or where the product is exposed to corrosive substances such as fertilisers, grass and plant residue including palm tree sap, bore water and other detrimental environmental exposure,
- Making mechanical adjustments that are inconsistent with the Manual- including, chains, bars, engine tuning etc....,
- Operating the product with incorrect fuel to oil ratio,
- Having made improper adjustments of ignition timing or the carburettor,
- Using the product with clogged or removed filters (i.e. fuel filter, oil filter, air filter),
- Using incorrect chain and bar oil/lubricant for the oil pump

In addition to the above, this Warranty DOES NOT cover the following:

- Products purchased:
 - Outside of Australia,
 - from a non - Authorised OX Group Dealer (such as purchases from unauthorised retailers and purchases over the internet, from local/ international sellers or sites such as Ebay),
 - at an auction, or
 - from a private seller.
- Accidental damage or damage caused by an extra ordinary event or circumstance beyond your or anyone else's control including damage caused by:
 - environmental factors,
 - natural discolouration of material due to ultraviolet light,
 - crushing, impact with hard surface or damage caused in the transit of the product, foreign material, or exposure of the product to excessive heat or cold or to solvents, or water entry into the product,
 - abnormal product performance caused by any ancillary equipment interference or other external factors,
- Damage or failure that occurs for a reason or reasons that were already disclosed to you (in writing or otherwise), prior to your purchase of the product,
- Damage or defects to the product that ought reasonably to have been revealed to you by an examination of the product, where you conducted such an examination before acquiring the product,
- Normal wear and tear due to the course of normal use,
- Freight costs associated transporting the product between you, the place of purchase, the Authorised OX Group Dealer and OX Group for the purposes of making a claim pursuant to this Warranty or otherwise,
- Repairs that are required by you to be made to the product which are simply due to a clogged or restricted exhaust system, carbon deposits in exhaust ports, piston crown or combustion chamber or periodic decarbonising,
- Products with serial number altered or removed,
- Refurbished, ex display or factory second products,
- Consumable items supplied with the product or that are a part of the product,
- Service parts,
- Accessories, that for the avoidance of doubt include but are not limited to the following: those included with the product at the time the product was purchased by you including cases & site bags, brushes, chucks, cord sets, bulbs, LED's & lamps, driver & drill bits, blades, driver blades, o - rings, switches & triggers, power tool attachments, blades and cutters, spark plugs, carburettor kits, filters, bars & chains, cutting equipment, recoil springs, rope, belts, measuring devices, air (pneumatic) fittings, nose caps, gaskets, fuel hoses,
- The product coming into contact with sand, water, rust, corrosion, fire, vermin and insect infestation, power outages or surges or inadequate voltage or current.

If the product you are using has been rented or leased by you, and you consider a claim might be made under this Warranty, you should refer the matter to the rental or leasing company immediately and they will handle the matter.

This Warranty does not cover service costs in replacing and maintaining consumable parts and accessories that have ceased working through normal wear and tear such as, but not limited to: drill heads, blades, cutters and other parts classifiable as a consumable part or accessory.

OX Group International Pty. Ltd.
ABN 41 151 919 569
PO Box 1875, North Sydney NSW 2059
(612) 8845 6600
www.oxtools.com.au



Notes

A series of horizontal dotted lines for taking notes, filling the majority of the page.



Notes

A series of horizontal dotted lines for writing notes.



Safety

Safety is not something that is taken lightly at OX. When we design and build our tools the safety of the operator and safety of the tool is always the most important factor that is well thought-out during the whole process.

Safety when using OX tools is of paramount importance. Ultimately safety comes down to the operator which is why instructions need to be read and adhered to. It is also important to ensure the correct safety clothing is worn whilst working on a construction site.

Environmental

OX Group is committed to managing environmental impact as an integral part of our operations. In particular, it is our policy to assure the environmental integrity of our processes and facilities at all times. We will do so by adhering to the following principles:

We employ management systems and procedures specifically designed to minimise the use of hazardous materials, energy and other natural resources, to minimise the generation of waste and to enable recycling and reuse of materials.

We continually seek opportunities to improve our environmental performance by establishing objectives and targets, measuring progress, and reporting our results; including but not limited to energy, water, paper and fuel consumption and vehicle miles travelled.

We promote participation and communicate our commitment to responsible environmental management by promoting environmental responsibility among our employees; by providing the necessary training and support to enable them to implement this policy; by informing suppliers of our environmental policy and encouraging them to adopt effective environmental management practices; and by soliciting input from our employees, suppliers, customers and board members in meeting our environmental goals.

OX[®]
UNLEASH THE POWER

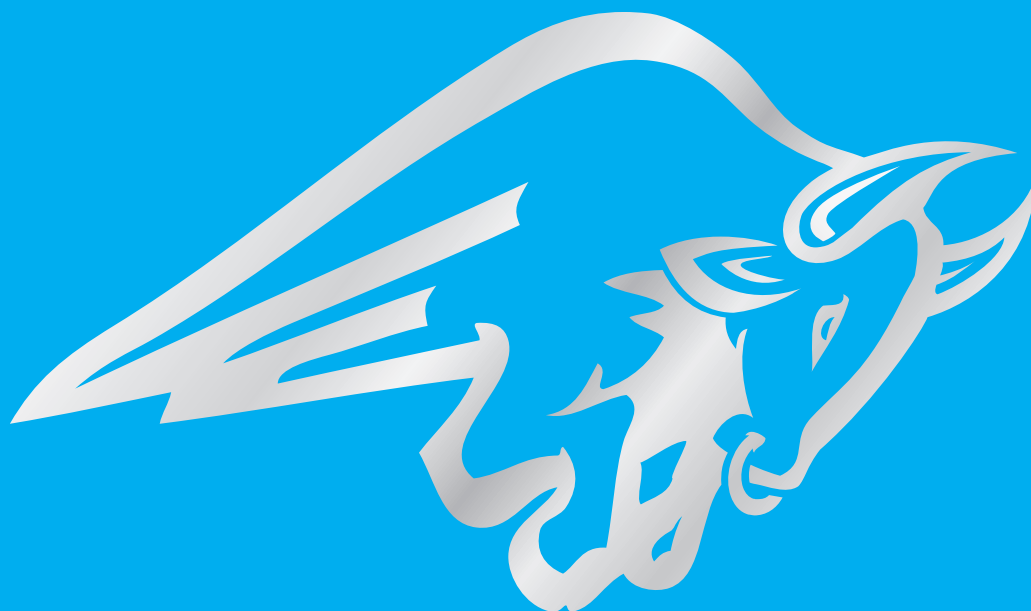

OX Group International
PO Box 498, Ermington
NSW 1700 AUSTRALIA

T: 02 8845 6600
F: 02 8845 6699
E: sales@oxgroup.com.au

For more information visit: oxtools.com

Subject to availability and OX Group International terms and conditions of sale. E & OE. © OX Group International